

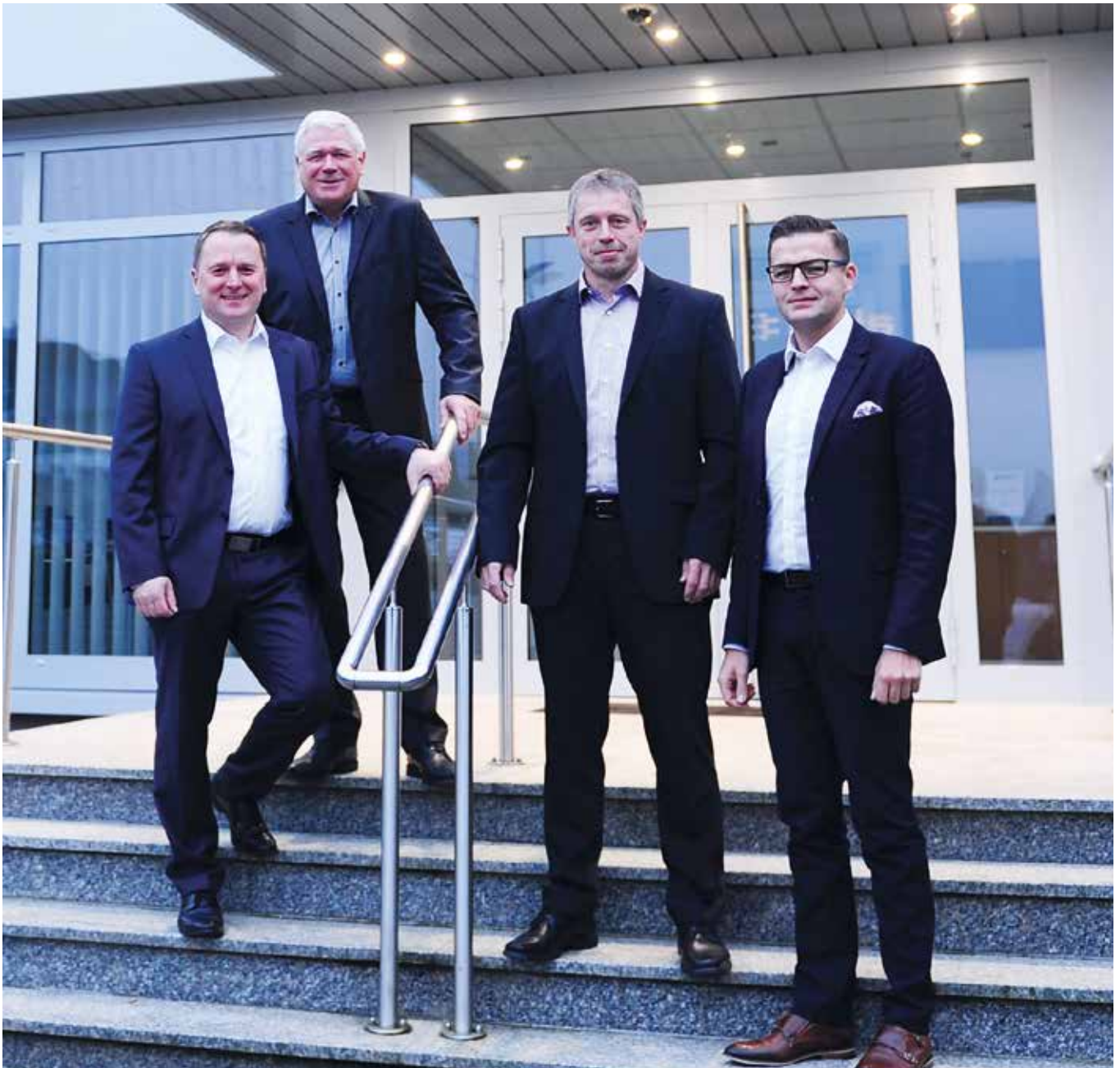

Main Catalogue



Extended management of Bals Elektrotechnik GmbH & Co. KG: Hubertus Fischer, Wolfgang Bals, Johannes Ramm und Piotr Komor (from left to right).

For over 60 years we have been producing CEE plug and connectors for the world market. That means quality you can always rely on. Our products prove themselves around the globe, in the most diverse applications. „Made in Germany“ stands for a quality standard that offers you the highest level of safety. We are very pleased about your interest in our company. We are proud of our entire portfolio, which you will find in this catalog. Do you have special wishes or requirements? We are happy to advise you and find individual solutions for you.

Wolfgang Bals
Managing Director

Johannes Ramm
Managing Director
Finance & Controlling

Hubertus Fischer
Production & Supply Chain

Piotr Komor
CTO / CCO International business

We ask you to indicate our reference numbers and quantity packaging on all your purchase orders in order to facilitate an easy procedure of the order.
Return shipments based on wrong placed orders effects a tremendous procedure and costs and therefore in such cases we are obliged to apply a handling charge.
Weights, dimensions, technical details and sketches are carefully issued (error excepted) but not obligatory on deliveries. For technical reasons our products are subject to modification continuously due to creative, design and technical progress.



Information

About us	4 - 9
Our brands	10 - 21
Technical information	22 - 31

Sockets

Surface mounting socket outlets	36 - 45
Combined surface mounting socket outlets	46 - 59
Surface mounting socket outlets, chemically resistant	60 - 63
Panel mounting socket outlets	64 - 77
Accessories for sockets	80 - 81



Plugs and connectors

Plugs	86 - 88
Inlets	89 - 103
Phase inverters, adapters and phase sequence indicators	104 - 106
Connectors	107 - 109
Accessories for plugs and connectors	110



Domestic plugs and sockets

Panel mounting socket outlets	118 - 120
Surface mounting socket outlets	121
Plugs and inlets	120 - 121
Connectors	121 - 122
Extension leads	122



Combinations

Surface mounting combinations	127 - 154
Mobile combinations	156 - 170
Hanging combinations	171 - 176
Bollards	177 - 179
Accessories	180 - 185



Special plugs and sockets

7-pole	190 - 193
Special grounding position 1h	194 - 196
Extra-low voltage	197 - 199
DC and 5h	200 - 204
Plugs and sockets above 125A	205



Plugs and sockets for special fields of application

Reefer container plugs and sockets	211 - 213
Plugs and sockets for military applications	215 - 223
Event technology	225 - 228
Camping plugs and sockets	230 - 232

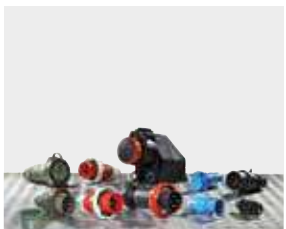

General Terms and Conditions, numerical table of contents

233 - 247

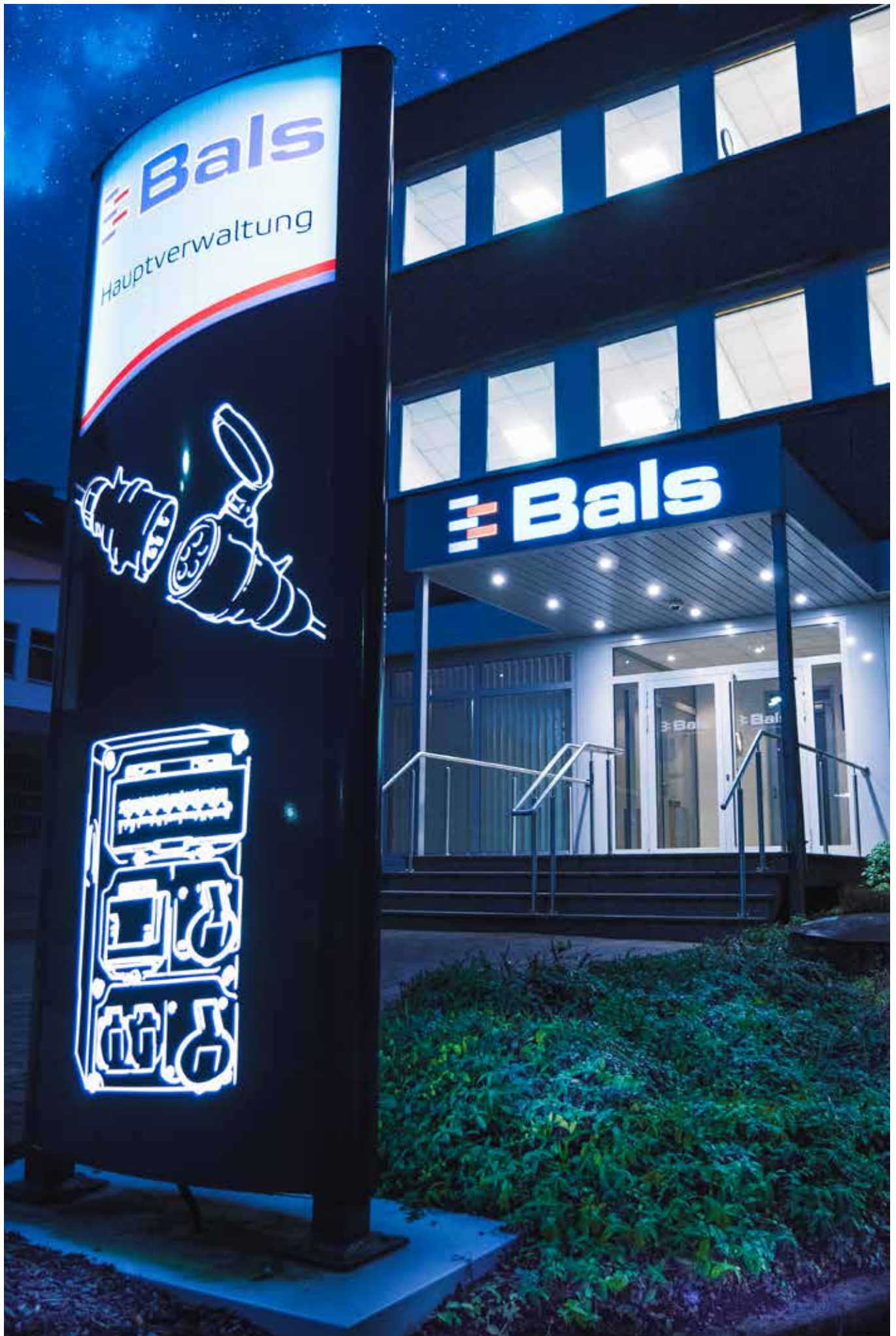

About half a century competence and experience

Bals stands worldwide as a quality brand for innovation, reliability and service. For more than 60 years, we have been producing CEE plugs and connectors for the world markets. From day one we have focussed on the highest level of quality "Made in Germany". Our factories in Kirchhundem-Albaum, Würdinghausen and Freivalde have highly skilled and motivated teams, the very latest manufac-

turing facilities and a highly efficient logistics system. Our product portfolio ranges from plugs, phase inverters, connectors, sockets outlets and combinations units to charging plugs and sockets for electrical vehicles. Numerous certifications from German and foreign certification institutes, as well as registered designs and patents, document the high technical standard of our products.



Three modern factories a consistent quality standard

From the beginning the headquarters of our company is located in Kirchhundem-Albaum (North-Rhine-Westphalia). Product development, marketing and sales, as well as administration are located here. In addition, plug and socket systems and special products are manufactured in the Kirchhundem-Albaum factory. The factory in Freivalde (Brandenburg), built in 1994 and expanded many times since, has state-of-the-art production facilities for fully-automatic manufacturing of unique CEE plugs and connectors as well as a highly-effective logistics centre. Our plant in Würdinghausen is brand new, this is where the components for Emobility are manufactured. Our training center is located in the adjoining building.



CEE plugs and connectors for the world market

As an independent, medium-sized, family-owned company, we produce standardised industrial plugs and sockets acc. to IEC 60309 1-2 as well as plug and socket systems, distributors and components for the infrastructure of electrical vehicles. We set new technical standards with innovations and ground-breaking, partially patented new developments such as MULTI-GRIP or QUICK-CONNECT. The export rate in excess of 50 percent shows: Our solutions are highly valued around the world. Our products are sold in more than 80 countries. Subsidiaries and exclusive partners in strategically important countries only sell our products.

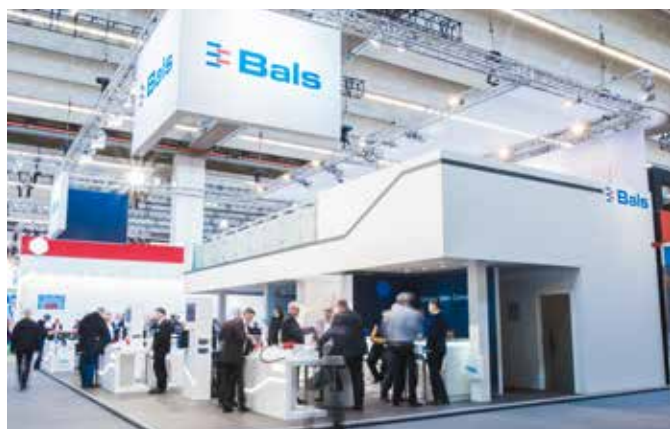

Customer proximity: You can rely on us

Always close to the customers. For us, this is no empty phrase but reality. Flexibility, customer orientation and the ability to quickly respond to short-term requirements are a matter of course for us. For this reason, integrated production - from the product idea and design to tool making and production to the shipment of the products - is optimised for short processing paths and the fastest response times.



People make the difference

Over 300 employees, who are dedicated and tightly connected to the company, have only one goal: to satisfy you, our customers, one hundred percent. This applies to the highest of quality stan-



dards that we apply to our product and also for made-to-measure service and personal contact from person to person.

Our responsibility to the highest quality

Quality does not permit any compromise. This has always been the maxim at Bals. The ISO-9001-certified production process in all factories ensures the well-known high product quality. This proof of quality is reflected in patents, certificates from German and foreign testing institutes, as well as the specification of Bals products by highly renowned companies. Innovation is an important quality benchmark for us. This way, we are always setting new standards with intelligent solutions that bring the user sustainable advantages.

Our responsibility to the environment

We know and love our region. Maintaining and protecting this unique landscape for future generations is important to us. Production that saves as many resources as possible, the highest environmental standards and continual enhancement of our ecological efficiency at all levels are a matter of course for us. Every individual employee at Bals is aware of this responsibility to people and nature.

Our responsibility to people and the region

As a family-owned company, we are well aware of our special responsibility. We keep jobs safe, encourage the development of every individual and are loyal to our sites which we care for and permanently develop in the long term. Thinking about the future is also important to us: For this reason, we create qualified training positions in a wide variety of professional areas each year. We support numerous local meetings and events and employ an above average number of people with handicaps.

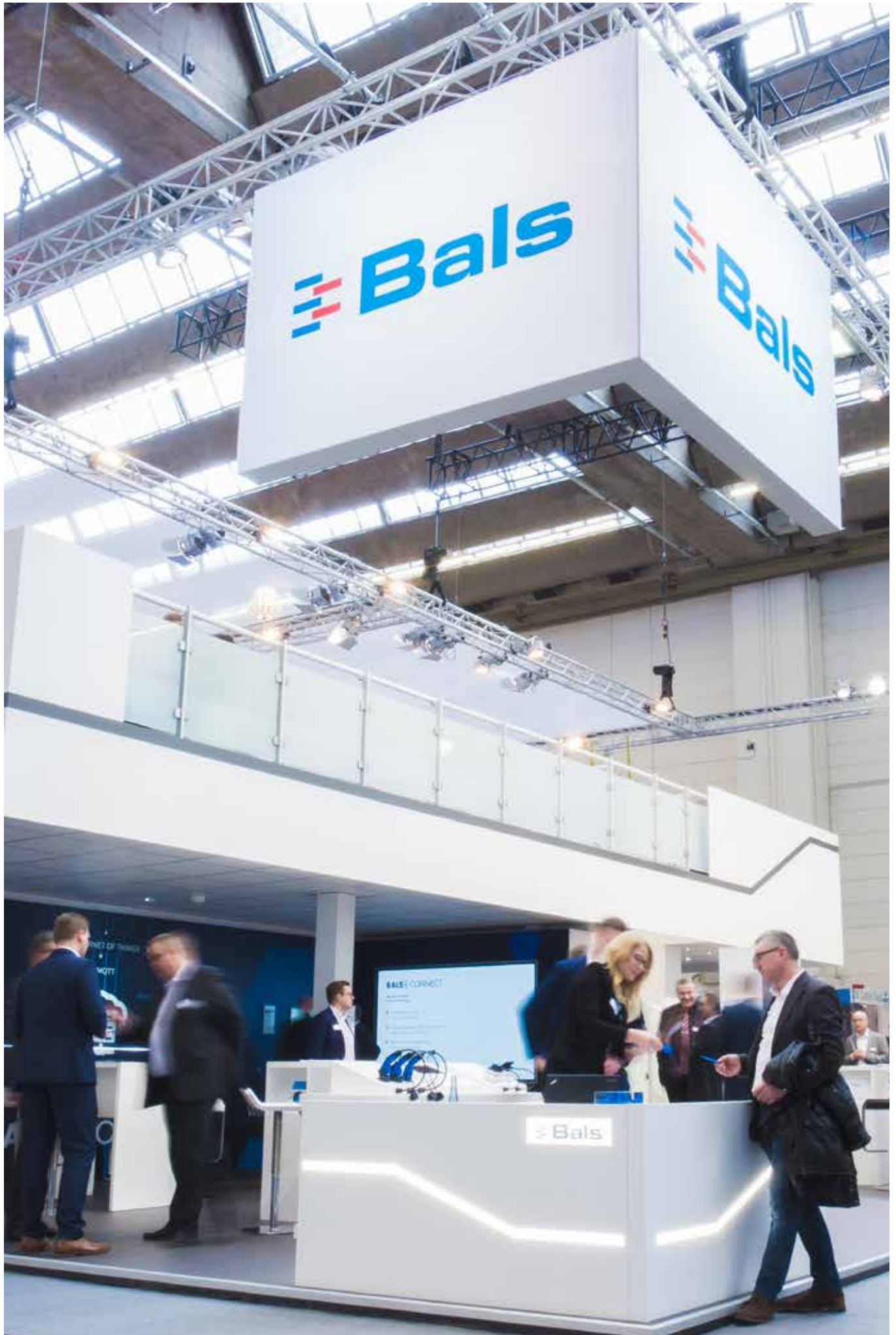

Proximity to customers is extremely important to us

We see ourselves as a partner for our customers and consider trust and continual dialogue to be extremely valuable. At the world's leading trade fairs, at conventions or directly on site: Our incentive is to support the success of our customers by providing tailor-made solutions.

Our sales teams are close to our customers all over the world and are always available to provide advice and support for complex technical requirements.

In Germany, a comprehensive sales network of 3 commercial agencies and 9 field representatives ensures close-knit and competent customer support. Abroad, we are present in important countries such as France, Switzerland, England, the Netherlands, Poland, Finland, Russia, India and China with sales subsidiaries of our own. Furthermore, we cooperate in many countries with committed partners on an exclusive basis in a spirit of trust.

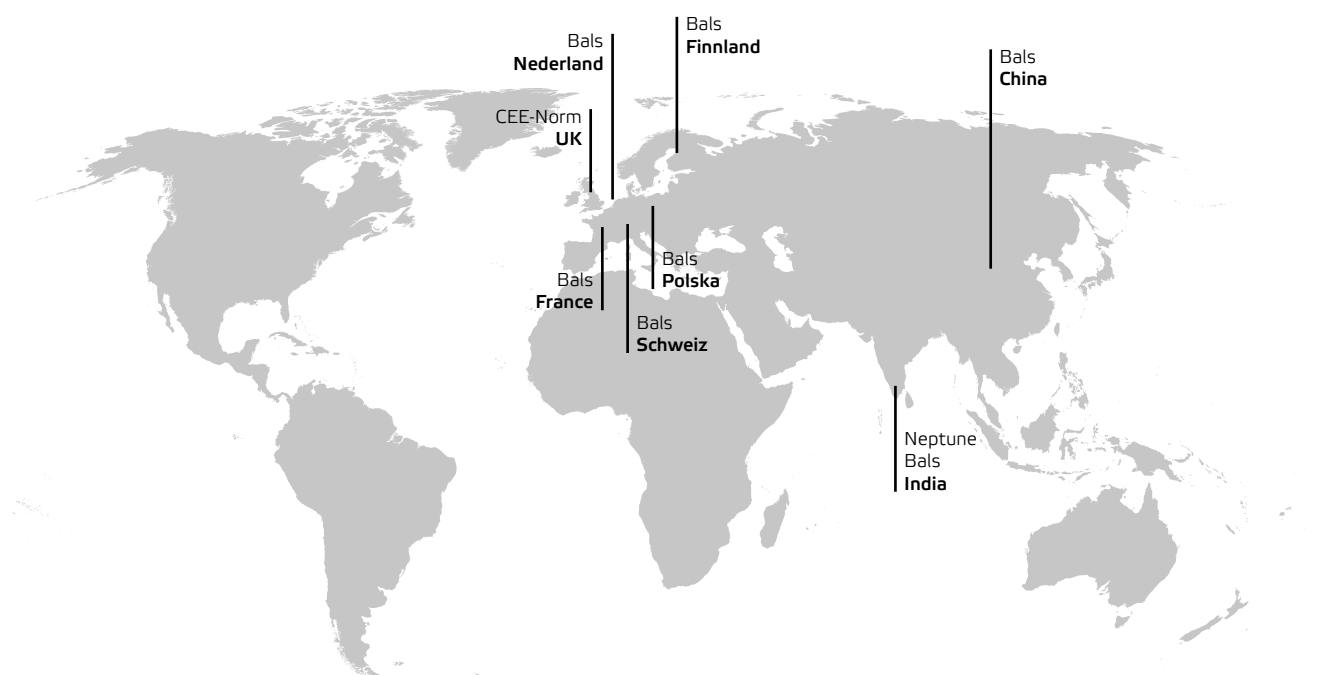

Bals subsidiaris worldwide

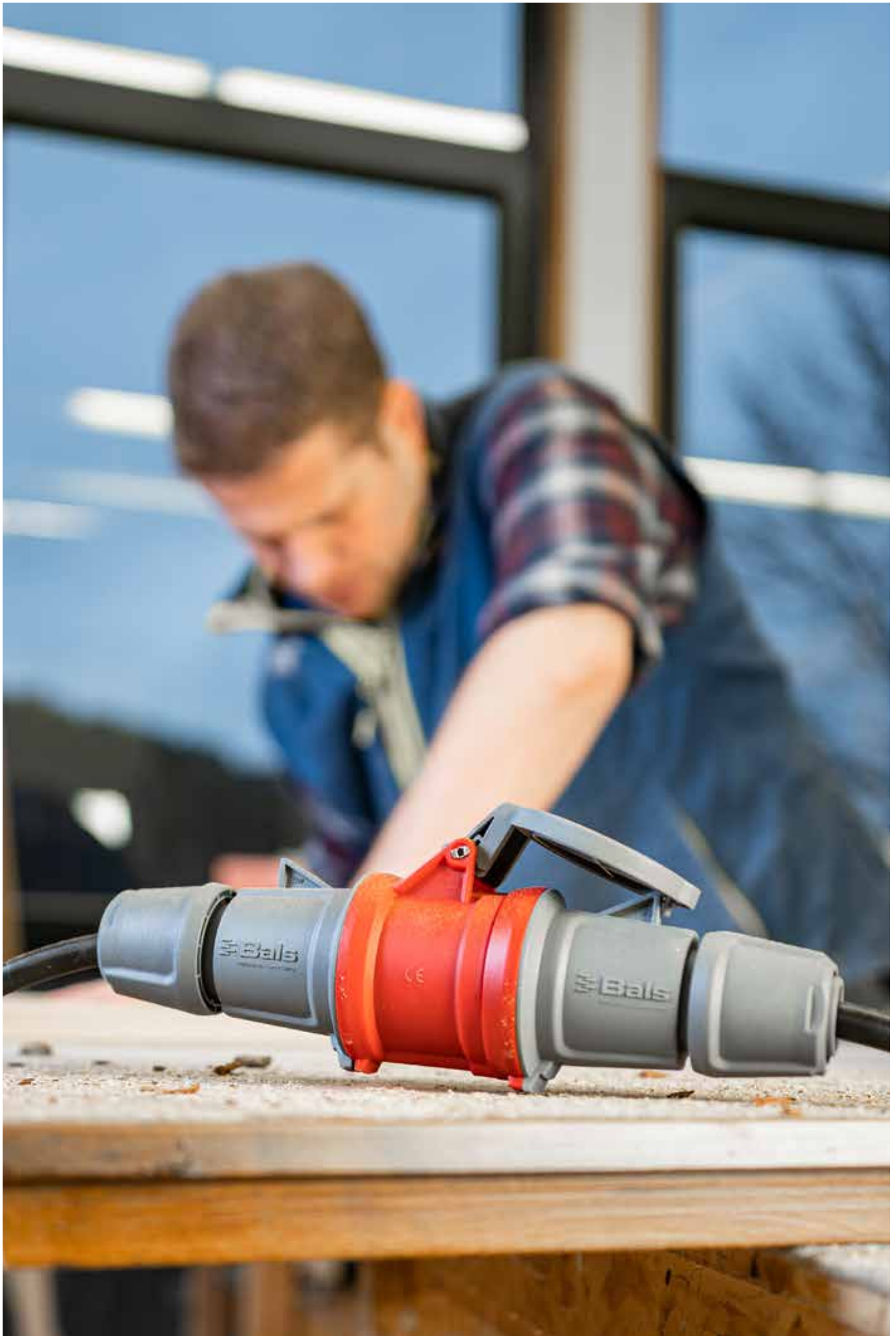

INNOLINQ

Our new, pioneering industrial plugs and sockets combine the highest demands for innovative technology, with resource-conserving production and the highest environmental standards providing products of the highest quality giving the "Made in Germany" seal of approval. The new design has been engineered for improved ergonomics, maximum stability, larger contact areas as well as reduced plugging and pulling forces. INNOLINQ contains no lead and is produced using only recyclable materials, thereby fulfilling the principle of sustainable production.

Resource-saving

INNOLINQ with QUICK-CONNECT contains no lead and is produced using only recyclable materials, thereby fulfilling the principle of sustainable production. It satisfies the strict planned EU REACH & RoHS directives of the future.

VDE-certified

The VDE symbol is the guarantee for tested, safe and standards-compliant products, including of course INNOLINQ. We monitor and document the high product standards in our own testing laboratory using selected thermal, mechanical and electrical tests.

Secure connection

INNOLINQ with QUICK-CONNECT guarantees a secure termination and thanks to the spring-connection technology, is resistant to vibrations and temperature fluctuations. The terminal visually and audibly locks the inserted stripped conductor at the touch of a finger ensuring a reliable and permanent connection.

Improved ergonomics

The improved contours of the housing and cable gland simplify handling and offer a perfect grip in every situation. An ideally placed recess for the thumbs further simplifies the opening of the connector cover. This shows that a modern design with simple handling is possible with this product range.

Extremely robust

Industrial plugs and sockets must be able to withstand extreme mechanical, thermal and chemical stresses. We therefore manufacture INNOLINQ from selected, recyclable and yet extremely durable materials - for maximum longevity and reliability.

Screwless installation

Install without tools thanks to QUICK-CONNECT connection technology. It's this easy: unscrew the housing, feed the connection cable through the open MULTI-GRIP cable gland. Guide the stripped conductors into the open terminals and lock in place with a simple click. Securely tighten housing parts and MULTI-GRIP cable gland.



Improved housing contours ensure simple handling, perfect grip and modern design.



The new INNOLINQ plugs and sockets are available from 16A to 32A.



Sustainable. Reliable. Innovative.

The new INNOLINQ series is the result of intensive research and development. The KONTEX-ULTRA connection technology is completely new – with contacts that are not only lighter than before, but also significantly reduce resource consumption – while maintaining stability and conductivity.

In addition, two proven Bals technologies that previously set new standards on the market were further improved – the patented QUICK-CONNECT connection technology and the MULTI-GRIP cable gland system.

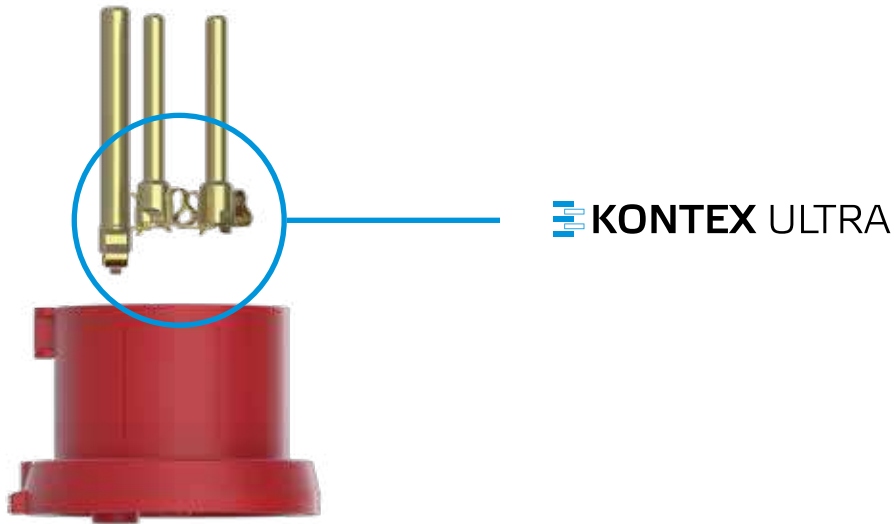

 **KONTEX ULTRA**

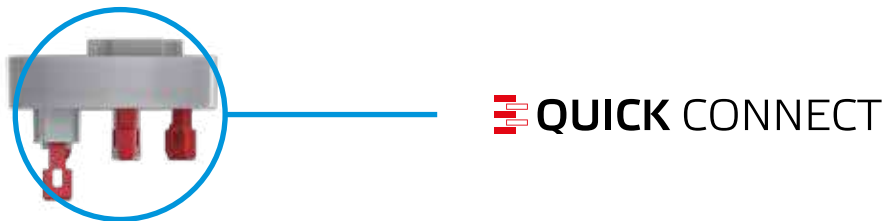

 **QUICK CONNECT**

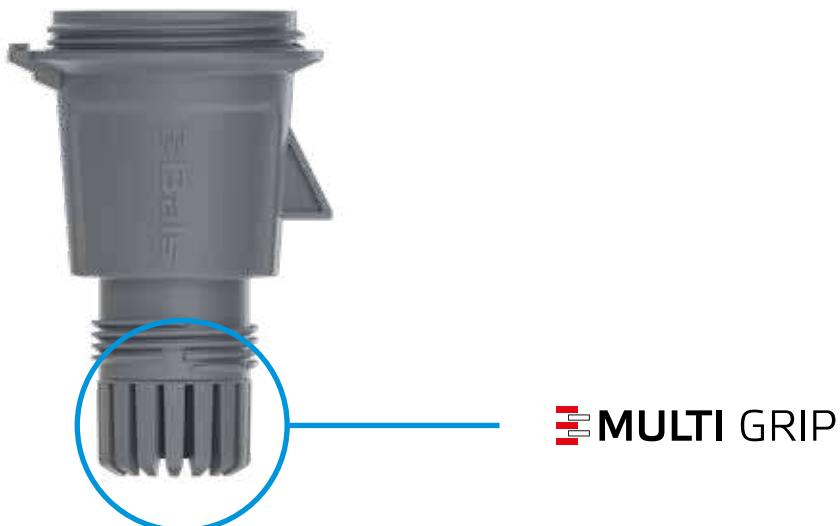

 **MULTI GRIP**





QUICK CONNECT

The classic - now even better. Thanks to the improved QUICK-CONNECT technology installation and termination is now even more secure.



Vibration-resistant

QUICK-CONNECT is insensitive to shocks, vibrations and temperature fluctuations. Thanks to spring-connection technology, the optimum connection of conductor and terminal can withstand even the most rigorous long-term vibration tests of independent testing institutes. A big advantage over standard screw connections, which tend to be prone to failure.



Greater contact surface

The newly designed spring terminal features an improved contact angle. The contact surface is thereby increased by nearly 70 %. This ensures a significantly better connection between conductor and contact.



Secure connection

INNOLINQ with QUICK-CONNECT guarantees a secure termination and thanks to the spring-connection technology, is resistant to vibrations and temperature fluctuations. The terminal visually and audibly locks the inserted stripped conductor at the touch of a finger ensuring a reliable and permanent connection.



Maintenance-free

QUICK-CONNECT is completely maintenance-free. The contact of the spring is optimised and preset ensuring a permanent constant pressure on the copper. Our conductor clamping thereby guarantees an optimum connection over the entire lifetime. Frequent inspections as with screw contacts are not necessary.



For all copper conductors

On delivery, the QUICK-CONNECT terminals are open and are suitable for copper conductors of all types and qualities – irrespective of conductor diameter and insulation type. Whether solid or flexible, with or without ferrule – the terminal accepts all copper conductors.

The following conductor cross sections can be used in the QUICK-CONNECT plugs and sockets:

QUICK-CONNECT plugs and connectors 16A:	1 mm ² - 2.5 mm ²	(flexible conductors)
QUICK-CONNECT panel and surface mounting socket outlets 16A:	1.5 mm ² - 4 mm ²	(rigid and multi-wire conductors)
QUICK-CONNECT plugs and connectors 32A:	2.5 mm ² - 10 mm ²	(flexible conductors)
QUICK-CONNECT panel and surface mounting socket outlets 32A:	2.5 mm ² - 10 mm ²	(rigid and multi-wire conductors)
QUICK-CONNECT plugs and connectors 63A:	6 mm ² - 16 mm ²	(flexible conductors)
QUICK-CONNECT panel and surface mounting socket outlets 63A:	6 mm ² - 25 mm ²	(rigid and multi-wire conductors)



Insert the stripped conductor in open terminals and close with a click.



Easy opening of the clamp with a standard screwdriver.



KONTEX ULTRA

Extra stable, patented and REACH- & RoHS-compliant - that is the new KONTEX ULTRA connection technology from Bals. KONTEX-ULTRA was developed under the title „Green-Connect“ to meet the environmental demands of an evolving industry.



Reach- & ROHS-compliant

INNOLINQ with QUICK-CONNECT satisfies the strict planned EU REACH & RoHS directives of the future.



Reduced plugging and pulling forces

Smooth surfaces on the pin and an improved sleeve design reduce the insertion and withdraw forces when plugging in or unplugging our INNOLINQ plug and socket systems. Furthermore, increased fitting accuracy simplifies handling considerably.



Resource-saving

INNOLINQ with QUICK-CONNECT contains no lead and is produced using only recyclable materials, thereby fulfilling the principle of sustainable production. It satisfies the strict planned EU REACH & RoHS directives of the future.



Improved conductivity

Our INNOLINQ products guarantee optimum contact and conductivity. This is ensured by a specially developed base material in combination with a highly complex strain-hardening technology of the contacts.



A special base material and highly complex, reinforced contacts improve the conductivity.



KONTEX-ULTRA now available in versions 16A and 32A.



MULTI GRIP

The original. We have revised the proven MULTI-GRIP principle -the cable entries now take even larger cable cross-sections.



Integrated strain relief

The universal MULTI-GRIP cable gland securely holds and seals a wide range of cable diameters. Simply turn to close, finished! Our MULTI-GRIP system fastens the cable and simultaneously ensures secure strain relief – without damaging the cable.



IP67-certified

The MULTI-GRIP cable glands achieve a minimum protection rating of IP67. The exterior strain relief system sits against the captive seal and prevents the penetration of water and dirt into the connection cavity of the plug system even if the cable is moved.



Maximum tensile strength

The tensile strength of our MULTI-GRIP cable gland exceeds the values specified in standards IEC 60309, EN 60309 and VDE 0623 many times over. Condition control and any maintenance of the strain relief can be performed from the outside without opening the plug system.



Larger cable cross sections

We have completely redesigned the cable entries of the INNOLINQ series of plug and socket systems to offer even more flexibility in use. The positive result: even larger cable diameters can now be used than in previous designs.

The following cable diameters fit into MULTI-GRIP:

TE- and TE-Plus plugs and connectors	Cable diameter	TLS and INNOLINQ plugs and connectors	Cable diameter
16A 3 and 4pole TE u. TE-Plus	Ø8 mm - Ø18 mm	TLS 16A 3 to 5pole	Ø8 mm - Ø18 mm
16A 5pole. TE and TE-Plus	Ø10 mm - Ø21 mm	TLS 32A 3 to 5pole	Ø11 mm - Ø23 mm
32A 3 and 4pole TE and TE-Plus	Ø11 mm - Ø23 mm	INNOLINQ 16A 3pol.	Ø7 mm - Ø18 mm
32A 5pole TE and TE-Plus	Ø13 mm - Ø27 mm	INNOLINQ 16A 4 u. 5pol.	Ø8 mm - Ø21 mm
63A 3 to 5pole TE and TE-Plus	Ø16 mm - Ø36 mm	INNOLINQ 32A 3 bis 5pol.	Ø11 mm - Ø29 mm
125A 3 to 5pole TE	Ø26 mm - Ø50 mm		

A reducer (type 29129) is available for all 16A plugs and sockets (see page 110). It allows cable diameters of less than ø 8 mm to be sealed tightly.

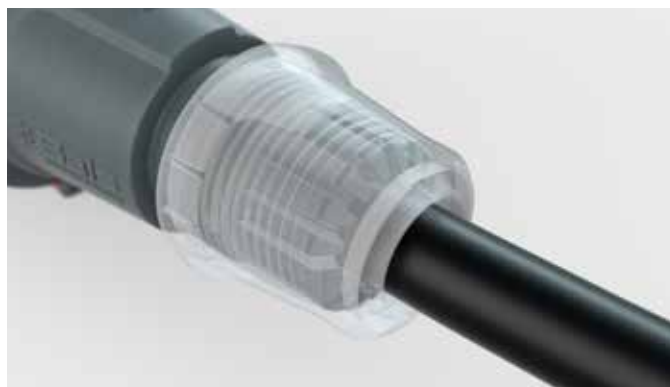

The MULTI-GRIP system fastens cables of various cross sections and ensures a secure strain relief.



The cable entries now accept even larger cable cross sections – for even more flexibility.



VARIABOX

- Fuse elements arranged below transparent, lockable operating window with user-friendly OTC mechanism (one touch close). It engages in the open state and locks again automatically when touched lightly
- Coded flange plate system for maximum safety during initial installation and maintenance
- All CEE sockets with screwless, maintenance-free QUICK-CONNECT technology and standardised flange dimensions, therefore independent of manufacturer if necessary
- Colours: bottom - black, top - electro-grey (enclosure top optionally available in the colours yellow, red, blue or silver)
- Surface mounting or mobile distributor versions in the sizes S (1-module), M (2-modules), L (3-modules), XL (4-modules), XXL (5-modules)
- Ready wired for installation
- Available in the protection degrees IP44, IP54 and IP67
- Enclosure made of high-grade, impact-resistant thermoplastic
- Top and bottom can be sealed together
- With external and internal fastening
- The cover screws are captive and can be actuated using a flat-tip or cross-tip screwdriver or using an internal or external hexagon spanner
- Modular expansion on all 4 sides
- Straight top hinged at side



Installation requires electrical expertise

Electrotechnical products which previously could only be acquired from specialist shops and which were intended for qualified specialist personnel are today also offered to anybody in hardware stores and online stores as part of changed purchasing habits. This change brings with it new questions, however: is it permitted for specialised trade products requiring expertise for installation to be purchased and installed by anybody?

Many products are intended for installation in electrical systems or for the repair of devices, for example. Home renovations are often associated with replacing switches, sockets and subdistributors, or installing them from scratch. Faulty installations may have fatal consequences! As a rule, electrical installations and attachments should only be performed by an electrical specialist.



Product safety legislation

The German Product Safety Act [ProdSG] requires that only safe products may be brought into circulation – safe both in terms of installation and actual use.

Since it is not legally possible to define a group of purchasers for electrotechnical products, manufacturers should clearly and unambiguously stress that specialist knowledge is required for the installation. This is most successful using pictograms which everybody can understand. They help manufacturers to comply with the German Product Safety Act, thus reducing their product liability risks.

Warning symbol „Installation, electrotechnical expertise“

In order to point out the hazard potential mentioned at the beginning, a visual notice is affixed to our packaging or directly onto our products which indicates that our products must exclusively be installed by electrical specialists.

This official product marking „Installation, electrotechnical expertise“ is standardised under IEC 60417- 6182 and is recommended by ZVEI, ZVEH and DKE.

Change to standard DIN EN 61439

As a successor standard to DIN EN 60439, standard DIN EN 61439 (2012) describes the requirements and documentation for all low-voltage switchgear assemblies. The standard is to be applied to power distributors, all switchgears and controlgears and meter cabinets. It therefore has a significant impact on electrical power distribution in industry, in building installation and on construction sites.

In future there will only be an overall view and the concept of the switchgear assembly. In place of a type test report, a design verification must be provided for new switchgears and power distributors. A low-voltage switchgear assembly is described through the definition of the interface parameters by the user or planner. Due to the interface parameters, the manufacturer must dimension and define the internal development of the low-voltage switchgear assembly.



The VARIABOX complies with DIN EN 61439

DIN EN 61439 (2012) is split between one part with general requirements and another part with a separate product standard for specific types of switchgear assemblies. The general basic requirements are laid out in DIN EN 61439-1 and adapted to the features of the application through relevant, additional sections of standards. As a result, we are able to apply the following three standards to our products:

1. Power switchgear assemblies in accordance with DIN EN 61439-2
2. Installation distributors in accordance with DIN EN 61439-3
3. Construction site power distributors in accordance with DIN EN 61439-4

Additional content of the standard is subdivided as follows: DIN EN 61439-5: Cable distribution cabinets, DIN EN 61439-6: Busbar distributors, DIN EN 61439-7: Switchgear assemblies for specific applications, spaces and installations of a special kind.

What does the standard mean for the end user?

DIN EN 61439 forms the basis for a clear definition of the performance promise that has been agreed between the user and manufacturer of a switchgear or controlgear system. Therefore, the fulfilling of the performance promise can be evaluated and represented for both parties. The effort involved in applying the new standard is not too dissimilar from the previous effort required. DIN EN 61439 leads the manufacturer to the required verifications in a structured manner. A manufacturer who applies the new standard correctly can definitively prove that its products can be operated safely and reliably.

Bals distributors: solutions tailored for DIN EN 61439

All plug-and-socket-device assemblies produced by Bals Elektrotechnik in accordance with the basic standard DIN EN 61439-1 and the corresponding standardisation sections DIN EN 61439-2, 61439-3 and 61439-4 can without exception be operated by non-experts. This includes the connection and disconnection of plug and socket devices as well as the operation of safety elements installed by us, such as miniature circuit breakers or residual current circuit breakers. The operating elements are installed in such a way that they comply with protection class IP 2X, which also covers protection class IP XXB (DIN EN 61439-3 Paragraph 8.2.2. and DIN EN 61439-2 Paragraph 8.101 Note 1). Non-experts are, of course, not permitted to open the housings of live assembly units. For this reason, it is only possible to open our housings using a suitable tool. Our distributors are usually pre-wired and ready for connection. For this reason, we are responsible for supplying verifications as the manufacturer of these products. We cannot declare any conformity for non-wired or partially wired devices requiring further modification, since the completion of the product is not performed by us on our premises.

I_n rated current of the assembly	IP degree of protection
I_{cc} rated conditional short-circuit current	U_{imp} rated voltage
RDF Rated load factor	

Type label example

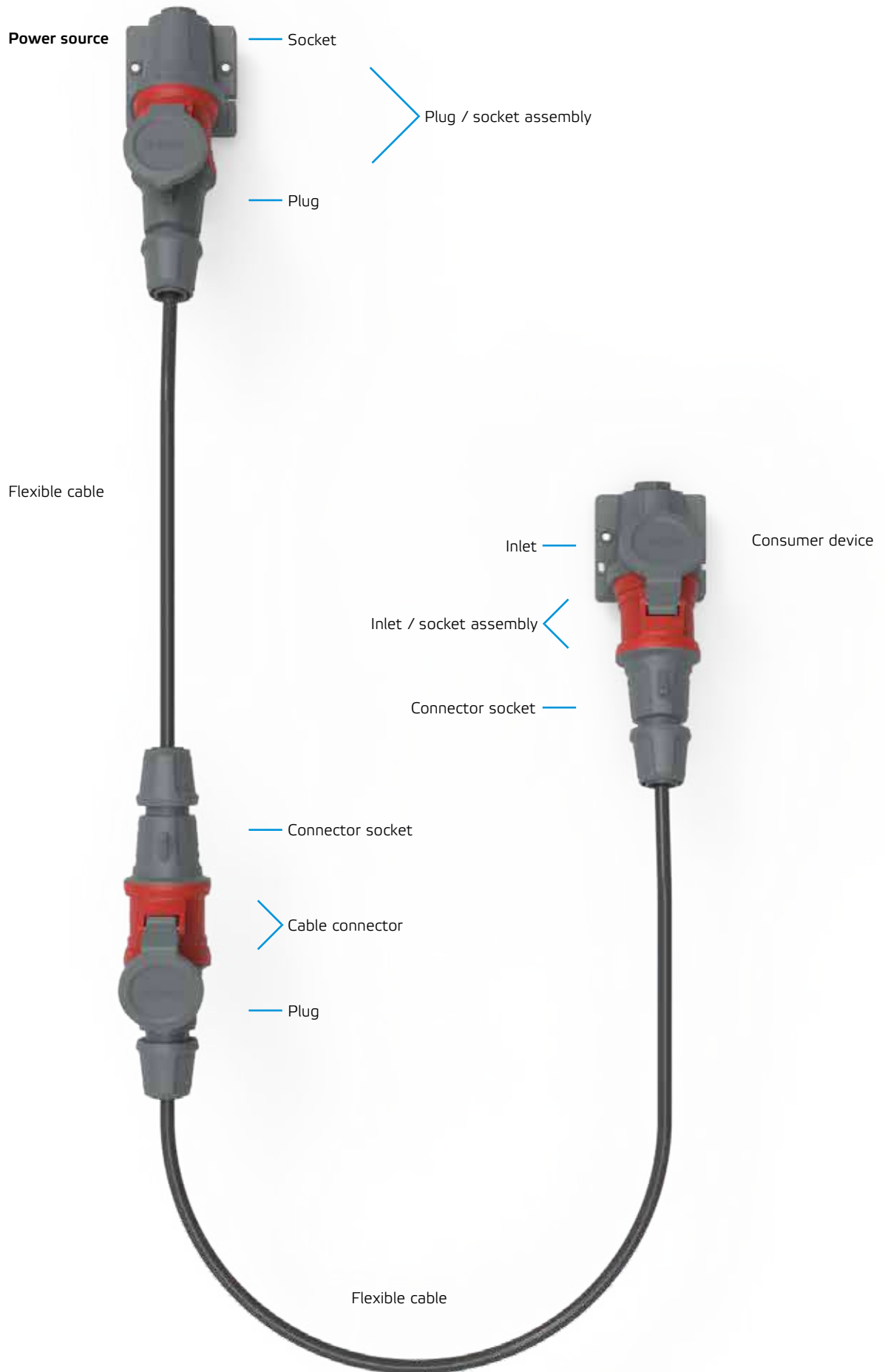

Information about CEE plugs and sockets for industrial applications

CEE plugs and sockets are internationally standardised by IEC 60309-1,-2 and also EN 60309-1,-2 valid in Europe.

IEC (International Electrotechnical Commission)

International electrotechnical commission responsible for worldwide standardisation in the electrotechnical field.

IECEE CB (IEC System for Conformity Testing to Standards for safety of Electrical Equipment)

IEC system for conformity testing of electrical equipment in accordance with safety standards.

CENELEC (European committee for electrotechnical standardisation)

International electrotechnical commission responsible for European standardisation in the electrotechnical field.

Series of EN 60309 standards

This European standard was ratified by CENELEC. The CENELEC members are obliged to comply with the requirements of the CEN/CENELEC rules of procedure which define the conditions under which this European standard is, without any modification, to be given the same status as a national standard.

This European standard shall exist in two official versions (English, French). A version in a different language that has been translated into the respective national language independently by the CENELEC member and communicated to the Central Secretariat shall have the same status as the official versions.

CEE standard system

To ensure that a plug cannot be inserted into a socket with a different voltage or frequency, the positions of the protective contacts relative to the keyway of the socket collar have been assigned to certain voltages and frequencies.

A groove in the connector collar and a corresponding lug on the plug prevent hazardous confusion between the systems. Even if this safety device is damaged, hazardous connection of the protective conductor pin and the phase sleeve is still not possible as the protective conductor pin which has a considerably larger diameter than the phase pin cannot be inserted into the phase sleeve.

Bals CEE plugs and sockets for amperages of 16A, 32A, 63A and 125A have sufficient switching capacity in accordance with DIN EN 60309 and can be actuated under load on consumables up to 690 V AC in accordance with DIN VDE 0100; corresponding test documents can be provided on request.

CEE plugs and sockets for amperages of 63A and 125A are equipped with a pilot contact that enables electrical interlocking or monitoring as per DIN EN 60309. This contact closes late when plugging in and opens early when pulling out.

System QUICK CONNECT

In 1998, Bals was the first manufacturer to introduce screwless connection technology based on the spring-clamp system onto the market under the brand name QUICK-CONNECT. Today, this technology developed by Bals is accepted and patented worldwide, is VDE-tested and has been approved without restriction.

The entire QUICK-CONNECT product range can therefore be used universally, consists of over 700 items and is available in all product categories and the customary protection degrees. Every year, Bals puts over 3 millions units of these unique products on the market worldwide and has consistently adapted its entire production and sales system to this innovation. The products are available from 16A 3p to 63A 5p as plugs, connectors and sockets.

QUICK-CONNECT puts an end to fault-prone threaded connections and prevents the inherent problems associated with insulation displacement connector technology. The time-saving and cost-cutting innovation from Bals is consistently marketed via the three-stage sales channel and, owing to its technical benefits and patented unique characteristics, offers major commercial opportunities for marketing agents and end users.

Bals focuses consistently on its inventions and therefore mentions a large part of the still available screw products only briefly at the end of this catalogue.

More information about the new technologies can be found on page 8 and 9, and on the introduction pages of the individual product groups.

Information

Position of protective contact and auxiliary lug

The illustration shows the position of the protective contact of a socket (front view) with rated operating voltages above 50 V, in accordance with DIN EN 60309-2. Plugs and inlets are mirror-inverted.

- 1) Mainly for ship installations
- 2) For reefer containers only (ISO standardised)
- 3) PE conductor required

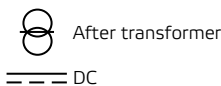
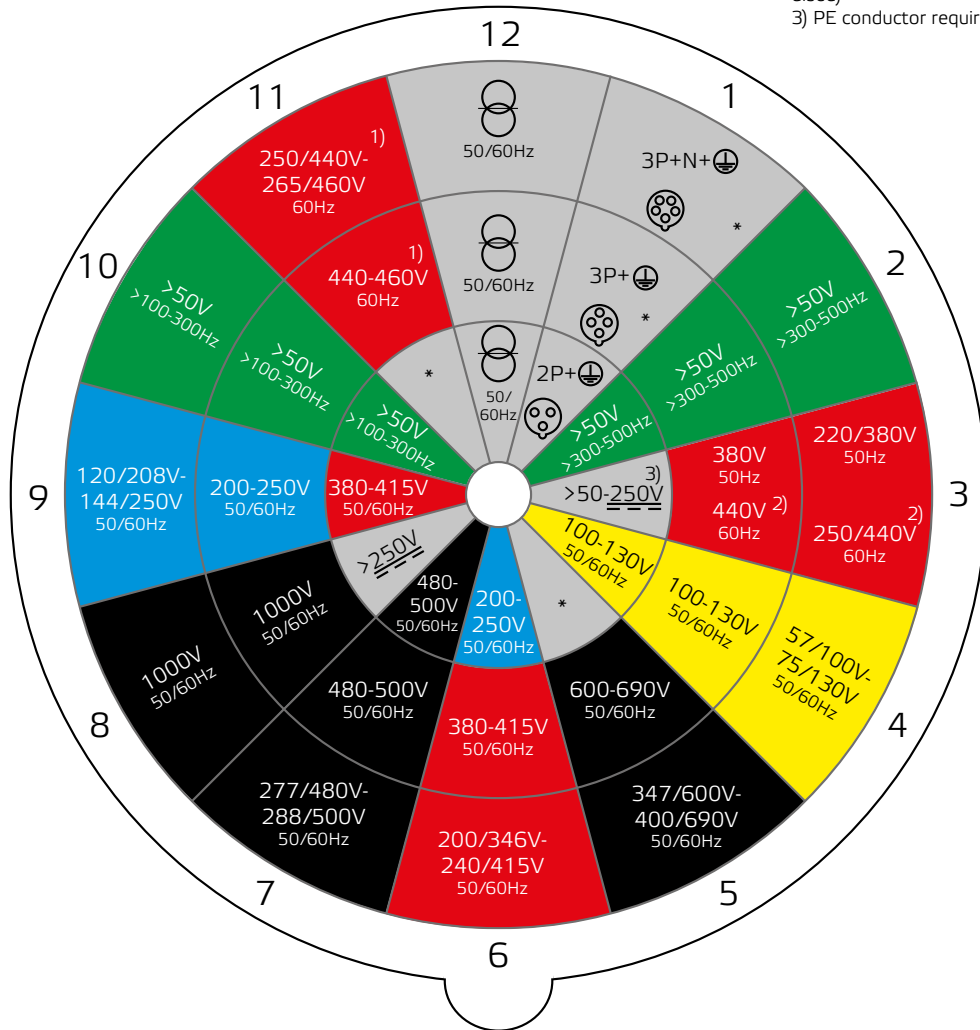







* All other configurations not covered by the rated operating voltages and / or frequencies. This clock face position can be additionally used in special applications when a distinction to standardized positions is required.

Position of the auxiliary lug relative to the basic lug for various voltages up to 50 V and frequencies up to 500 Hz in accordance with DIN EN 60309-2.

Poles	Frequency	Rated operating voltage	Position of auxiliary lug	Kennfarbe
2-, 3pol.	50 and 60	20 - 25	none	violet
	50 and 60	40 - 50	12 h	white
	100 - 200	40 - 50	4 h	green
	300	20 - 25 40 - 50	2 h	green
	400	20 - 25 40 - 50	3 h	green
	above 400 - 500	20 - 25 40 - 50	11 h	green

Colour Coding

When the operating voltage is indicated colour codes in addition to specified labels, the colour code given in the table below should be used:

Rated operating voltage or frequency	colour code
20 - 25 V	violet 
40 - 50 V	white 
100 - 130 V	yellow 
200 - 250 V	blue 
380 - 480 V	red 
500 - 690 V	black 
above 60-500 Hz	green 

Contact layout for CEE plugs and sockets

Greater than 50 V:

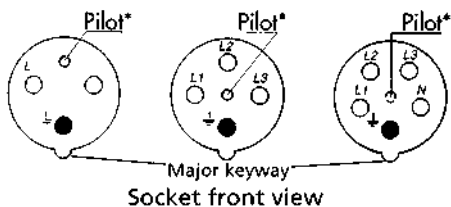

Up to 50 V:

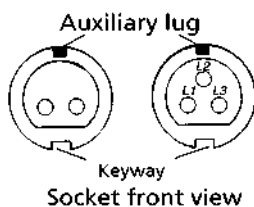

Identification of conductor connections















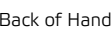

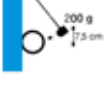

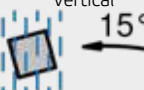



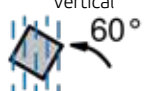
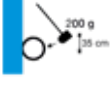



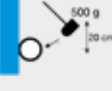

The connections must be labelled with the following symbols: L1, L2, L3 or 1, 2, 3 for the outer conductors.

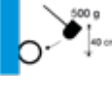
The neutral conductor is labelled with N and the earth contact with 

*only at 63A and 125A

IP protection degrees for enclosures as per DIN EN 60529 (DIN VDE 0470)

IK-code as per DIN EN 62262 (VDE 0470)

1st code digit	Protection of the enclosure against penetration by	Protection against contact with	2nd code digit	Protection of the enclosure against harmful effects by	Code digit	Impact resistance
0	no protection 	no protection 	0	no protection 	0	not protected according to standard
1	Solid objects larger than 50mm 	Back of Hand 	1	Vertically falling dripping water 	01	Energy 0,140 Joule 
2	Solid objects larger than 12,5mm 	Finger 	2	Dripping water up to 15° relative to vertical 	02	Energy 0,200 Joule 
3	Solid objects larger than 2,5mm 	Tool 	3	Dripping water up to 60° relative to vertical 	05	Energy 0,700 Joule 
4	Solid objects larger than 1mm 	Wire 	4	Splashing water from all directions 	06	Energy 1 Joule 
5	Damaging dust deposits 	Wire 	5	Water jet from all directions 	07	Energy 2 Joule 
6	Dust-proof (full protection) 	Wire 	6	Strong water jets 	08	Energy 5 Joule 
			7	Immersion under specific pressure and time conditions 	09	Energy 10 Joule 
			8	Immersion under specific pressure for indefinite time* 	10	Energy 20 Joule 

Example IP67:

6 - Dust-proof (full protection)

7 - Immersion under specific pressure and time conditions

* Conditions are defined jointly by the manufacturer and end user. Tightening of the test conditions compared to code digit 7.

All Bals plugs and sockets are:

Impact-resistant, even at extremely low temperatures

Tested from -25°C up to +40°C

Dimensionally stable, even with high heat generation

Glow wire test at 650°C and 850°C

Protected against splashing water, watertight and dust-proof in accordance with protection degrees IP44 and IP67

Tests in accordance with DIN EN 60529, e.g. at water depth of 1 m

High switching capacity, can therefore also be connected and disconnected under load

Contacts and insert are subjected to a continuous mechanical, electrodynamic and thermal load

Ageing resistant

Long-term testing at a temperature of 80°C

Good electrical insulation properties

Plastic parts used insulate voltages of ≥ 2500 V~

Dimensionally stable and abrasion-resistant

Tested through years of use under harsh operating conditions

Environmentally friendly

Plugs and sockets are cadmium-free

The same generally applies for the plug/socket combination systems as for plugs and sockets, whereby here it is particularly important to take resistance against chemicals into consideration. The high-quality plastics and solid rubber used are suitable for the majority of applications. If, however, chemicals are used (e.g. for cleaning tasks in food processing plants), it may be necessary to use a different material (see "Material resistance list" on page 21) or contact us.



Glow wire test



Product testing at -25°C

Material resistance list

This list contains the most common chemicals. It provides information on the basic resistance of the listed materials in combination with the listed chemicals. The concentration of the chemicals and the ambient temperature must additionally









be taken into consideration. If other chemicals or a combination of chemicals are used, it is essential to perform a precise chemical resistance check.

■ resistant ■ conditionally resistant □ non-resistant

	Polyamide	Polycarbonate	Polyester	Rubber
Acetic acid 10%	□	■	■	□
Acetone	■	□	■	■
Alcohol (ethyl alcohol)	■	■	■	■
Alcoholic beverages	■	■	■	■
Ammonium (aqueous)	■	□	■	■
Benzene	■	□	■	□
Bromine	□	□	□	□
Butter	■	□	■	□
Caustic detergent solutions	■	■	■	■
Chlorine	■	■	■	■
Curd soap solution (2%)	■	■	■	■
Dichloromethane	■	□	□	□
Diesel oil, heating oil	■	■	■	■
Edible oils and edible fats	■	■	■	■
Ethyl ether	■	□	■	□
Fruit juices	■	■	■	■
Glycerine	■	■	■	■
Glycol	■	■	■	■
Hydrochloric acid (up to 35%)	□	■	□	■
Hydrofluorocarbons	■	□	■	□
Hydrogen peroxide (30%)	■	■	■	■
Iodine	□	■	□	■
Lard	■	□	■	■
Methanol	■	□	■	■
Milk	■	■	■	■
Mineral oils and mineral greases	■	■	■	■
Nitrobenzene	■	□	■	□
Ozone	□	■	□	■
Perchloroethylene	■	□	■	□
Petrol	■	■	■	□
Premium petrol (aromatic)	■	□	■	□
Soap solution (aqueous)	■	■	■	■
Sulphuric acid (up to 40%)	□	■	□	■
Toluene	■	□	■	□
Trichloroethylene	■	□	□	□
Urea	■	■	■	■
Washing-up liquid	■	■	■	■
Water (hot)	■	■	■	■
Water and seawater (cold)	■	■	■	■

Source: Werkstoff-Führer Kunststoff (Material Guide - Plastic)Hellerich/ Harsch/ Haenle 6th edition Bayer Kunststoff

Principal used materials and properties of Bals CEE plugs and sockets

	Connection technology	Material of contact carrier	Material of contact	Material of enclosure	Material of cover rivet	Material of fastening screw	Material of contact screw
TLS plug	Screw terminal	PA6	Brass	PA6	-	Steel blue galvanised	Steel nickel plated
Standard plug	 QUICK CONNECT	PA6	Brass	PA6	-	-	-
TE plug	Screw terminal	PA6.6	Brass nickel-plated	PA6	-	Stainless Steel V2A	Steel nickel plated
TE-Plus plug	 QUICK CONNECT	PA6.6	Brass nickel-plated	PA6	-	Stainless Steel V2A	-
TLS connector	Screw terminal	PA6	Brass	PA6	Brass	Steel blue galvanised	Steel nickel plated
Standard connector	 QUICK CONNECT	PA6	Brass	PA6	Brass	-	-
TE connector	Screw terminal	PA6.6	Brass nickel-plated	PA6	Stainless Steel V2A	Stainless Steel V2A	Steel nickel plated
TE-Plus connector	 QUICK CONNECT	PA6.6	Brass nickel-plated	PA6	Stainless Steel V2A	Stainless Steel V2A	-
Surface Mounting Socket Outlet Standard	 QUICK CONNECT	1)	2)	3)	Brass	4)	-
TE Surface Mounting Socket Outlet	 QUICK CONNECT	PA6.6	Brass nickel-plated	3)	Stainless Steel V2A	Stainless Steel V2A	-
Panel Mounting Socket Outlet Standard	 QUICK CONNECT	1)	2)	PA6	Brass	-	-
TE Panel Mounting Socket Outlet	 QUICK CONNECT	PA6.6	Brass nickel-plated	PA6	Stainless Steel V2A	-	-
Inlets	 QUICK CONNECT	1)	2)	PA6	-	-	-
TE inlet	 QUICK CONNECT	PA6.6	Brass nickel-plated	PA6	-	-	-

1) 16 + 32A made of PA6
63A made of PA6.6

2) 16 + 32A made of brass
63A made of brass (nickel-plated)

3) 16 + 32A made of PA6
63A made of PC

4) 16 + 32A made of steel (blue, galvanised)
63A made of stainless steel A2

PA6 (polyamide) and PC (polycarbonate) are high-grade plastics that are predominantly used for plugs, sockets and combinations
PA6.6 (polyamide with glass-fibre content) is a high-grade plastic that is characterised in particular by its high heat resistance.

Withdrawal forces for MULTI-GRIP cable gland system

Plug / connector	Cable ø	Torque		Pulling force as per EN 60309	Measured pulling force*
		min.	max.		
16A 3 and 4 pol.	8 mm	4 Nm	7 Nm	80 N	85 N (300 N)
16A 3 and 4 pol.	18 mm	4 Nm	7 Nm	80 N	200 N
16A 3 and 4 pol.	< 7 mm	4 Nm	7 Nm	with reducer type 29129	300 N
16A 5 pol. TLS and QC	8 mm	4 Nm	7 Nm	80 N	85 N
16A 5 pol. TLS and QC	18 mm	4 Nm	7 Nm	80 N	200 N
16A 5 pol. TE	10 mm	4 Nm	7 Nm	80 N	400 N
16A 5 pol. TE	21 mm	4 Nm	7 Nm	80 N	600 N
32A 3 and 4 pol.	11 mm	4,5 Nm	9 Nm	100 N	400 N
32A 3 and 4 pol.	23 mm	4,5 Nm	9 Nm	100 N	600 N
32A 5 pol. TLS and QC	11 mm	4,5 Nm	9 Nm	100 N	400 N
32A 5 pol. TLS and QC	23 mm	4,5 Nm	9 Nm	100 N	600 N
32A 5 pol. TE	13 mm	5 Nm	9,5 Nm	100 N	350 N
32A 5 pol. TE	27 mm	5 Nm	9,5 Nm	100 N	550 N
63A 3 - 5 pol.	24 mm	7,5 Nm	20 Nm	120 N	1900 N
63A 3 - 5 pol.	27 mm	7,5 Nm	20 Nm	120 N	2000 N
125A 3 - 5 pol.	36 mm	10 Nm	22 Nm	200 N	2700 N
125A 3 - 5 pol.	41 mm	10 Nm	22 Nm	200 N	2200 N

* Measured pulling force:
Room temperature 20°C, testing machine type TIRA tes 2710/1 Non-binding guideline values.
Rubber of cable: H07RN-F Reserve technical changes.





- 1
- 2
- 3
- 4
- 5
- 6
- 7

Surface Mounting Socket Outlets

Surface Mounting Socket Outlets IP44



Pages 36 - 37

Surface Mounting Socket Outlets Straight IP44



Page 37

Surface Mounting Socket Outlets Straight IP67



Page 38

Surface Mounting Socket Outlets IP67



Pages 38 - 40

Surface Mounting Socket Outlets Combined



Page 41

Surface Mounting Socket Outlets Aggressive Cond.



Pages 42 - 43

Surface Mounting Socket Outlets with „PSC“



Page 44

Combined Surface Mounting Socket Outlets

Fused



Pages 46 - 52

Switched, Interlocked



Pages 53 - 55

Switched, Fused



Pages 56 - 57

Switched, Interlocked, Fused



Pages 58 - 59

Combined Surface Mounting Socket Outlets for harsh and / or aggressive Ambient Conditions

Switched, Interlocked



Pages 60 - 61

Switched, Interlocked, Fused



Pages 62 - 63

Panel Mounting Socket Outlets

Straight, IP44



Pages 64 - 66

Angled, IP44



Pages 66 - 68

Straight, IP67



Pages 69 - 71

Angled, IP67



Pages 71 - 73

With Auxiliary Contact or PSC



Pages 74 - 75

For Harsh or Aggressive Conditions



Pages 76 - 77

Architecture program



Page 78 - 79

Accessories for Sockets



Pages 80 - 81

Technical features

**INNOLINQ with KONTEX ULTRA**

- INNOLINQ with KOTEX-ULTRA satisfies the strict planned EU REACH & RoHS directives of the future
- Smooth surfaces on the pin and an improved sleeve design reduce the insertion and withdraw forces
- a specially developed base material in combination with a highly complex strain-hardening technology guarantee optimum contact and conductivity
- INNOLINQ with KOTEX-ULTRA contains no lead

**Screwless QUICK CONNECT terminals 16A and 32A**

- All QUICK-CONNECT sockets are touch-safe
- No wire end ferrules necessary
- Pressing the contact slide with your finger closes the terminal
- Reliable and permanent connection by means of spring-clamp technology
- The damage-free conductor clamping guarantees an optimum connection over the entire service life
- Rewiring without additional handling of the conductor

**Surface Mounting Socket Outlets QUICK CONNECT**

- Cable entry from above
- Removable insert
- QUICK-CONNECT terminals
- External fastening

**HKS panel mounting sockets for elegant control, regulation, monitoring, checking**

- Additional auxiliary contact switch (HKS) is actuated by the plug
- Available on CEE angled Panel Mounting Socket Outlets 16A and 32A as well as on Domestic sockets
- Electrical plug interlocking possible
- Potential-free switching
- Switching element, e.g. contactor, can be set separately

**Wall mounting socket outlet
INNOLINQ**

- Screwless terminals
- The cable entry is one at top open and one at bottom and one rear side closed
- Protection degree IP44
- Contact carrier is made of high temperature resistant material
- Contains no lead

QUICK CONNECT
KONTEX ULTRA



110635

Ampere	Poles	110V	230V	400V	500V	>50V	>50V	Quantity	Each
		50-60 Hz	50-60 Hz	50-60 Hz	50-60 Hz	100-300Hz	301-500Hz		
16	4	110668	110672	110670	110671	110673	110666	10	
16	5	110622	110626	110624	110625	110627	110620	10	264
32	3	110644	110646	110649	110647	110650	110642	10	
32	4	110656	110661	110658	110660	110662	110653	10	321
32	5	110633	110637	110635	110636	110638	110631	10	353

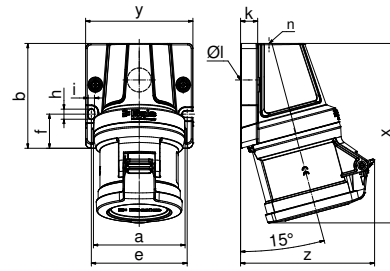

Ampere	16	16	32	32	32
Polzahl	4	5	3	4	5
a	80,0	80,0	80,0	80,0	80,0
b	92,0	92,0	92,0	92,0	92,0
e	84,0	84,0	84,0	84,0	84,0
f	30,0	30,0	30,0	30,0	30,0
h	9,0	9,0	9,0	9,0	9,0
i	5,5	5,5	5,5	5,5	5,5
k	15,0	15,0	15,0	15,0	15,0
ø l	21,0	21,0	21,0	21,0	21,0
n	M32	M32	M32	M32	M32
x	144,0	145,0	157,0	157,0	158,0
y	94,0	94,0	94,0	94,0	94,0
z	110,0	114,0	112,0	112,0	118,0
Cond. mm² min	1,0	1,0	2,5	2,5	2,5
Cond. mm² max	4,0	4,0	10,0	10,0	10,0

**Surface Mounting Socket Outlet
QUICK-CONNECT**

- Screwless terminals
- Kontex contact
- Cable entry 1x at top (open), 1x at bottom and 1x at rear (closed)
- Base rotatable by 180°
- Protection degree IP44

QUICK CONNECT



11906

Ampere	Poles	110V	230V	400V	500V	>50V	>50V	Quantity	Each
		50-60 Hz	50-60 Hz	50-60 Hz	50-60 Hz	100-300Hz	301-500Hz		
16	3	11928	11930	11931	11932	11933	11934	10	185
16	4			11907				10	240
16	5			11906				10	260

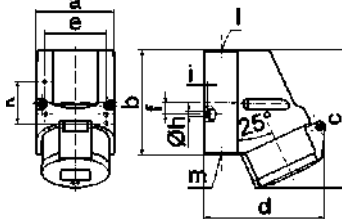

Ampere	16	16	16
Poles	3	4	5
a	64,0	75,0	75,0
b	87,0	100,0	100,0
c	117,0	129,0	131,0
d	103,0	108,0	116,0
e	51,0	59,0	59,0
f	-	11,0	11,0
ø h	4,1	5,1	5,1
i	4,5	4,5	4,5
k	40,0	-	-
l	M20	M20	M20
m	für M20	für M20	für M20
Cond. mm² min	1,5	1,5	1,5
Cond. mm² max	4	4	4

1 MB 7

**Surface Mounting Socket Outlet
QUICK-CONNECT**

- Screwless terminals
- Kontex contact
- Cable entry 1x at top (open), 2x at bottom (closed)
- Base rotatable by 180°
- Suitable for feed-through wiring with special terminals
- Protection degree IP44

QUICK CONNECT

Twin terminal



11909

Ampere	Poles	110V	230V	400V	500V	>50V	>50V	Quantity	Each
		50-60 Hz	50-60 Hz	50-60 Hz	50-60 Hz	100-300Hz	301-500Hz		
16	4			11944	11945			10	305
16	5			11909	11947			10	325
32	3	11948	11949					10	350
32	4		11955	11956	11957	110073		10	365
32	5	11960	110322	11962	11963			10	405
16	5			110451				10	330

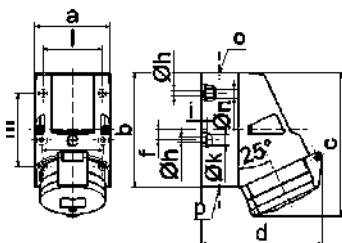

Ampere	16	16	32	32	32
Poles	4	5	3	4	5
a	83,0	83,0	83,0	83,0	83,0
b	126,0	126,0	126,0	126,0	126,0
c	153,0	155,0	155,0	155,0	155,0
d	127,0	130,0	130,0	130,0	136,0
e	68,0	68,0	68,0	68,0	68,0
f	11,0	11,0	11,0	11,0	11,0
ø h	5,5	5,5	5,5	5,5	5,5
i	6,5	6,5	6,5	6,5	6,5
ø k	12,0	12,0	12,0	12,0	12,0
l	65,0	65,0	65,0	65,0	65,0
m	80,0	80,0	80,0	80,0	80,0
ø n	10,0	10,0	10,0	10,0	10,0
o	M25	M25	M25	M25	M25
p	2xM25	2xM25	2xM25	2xM25	2xM25
Cond. mm² min	1,5	1,5	2,5	2,5	2,5
Cond. mm² max	4	4	10	10	10

1 MB 2

Surface Mounting Socket Outlet QUICK-CONNECT, straight

- Screwless terminals
- Kontex contact
- Cable entry 7x M20/25
- With large wiring space
- Protection degree IP44

QUICK CONNECT



110558

Ampere	Poles	110V 50-60 Hz	230V 50-60 Hz	400V 50-60 Hz	500V 50-60 Hz	>50V 100-300Hz	>50V 301-500Hz	Quantity	Each
		3pol 4pol 5pol 4h 4h 4h	3pol 4pol 5pol 6h 9h 9h	3pol 4pol 5pol 9h 6h 6h	3pol 4pol 5pol 7h 7h 7h	3pol 4pol 5pol 10h 10h 10h	3pol 4pol 5pol 2h 2h 2h		
16	3	110542	110541	110543				10	320
16	4	110545	110544	110546				10	335
16	5	110548	110547	110549				10	355
32	3	110551	110550	110552				10	380
32	4	110554	110553	110555				10	395
32	5	110557	110556	110558				10	435

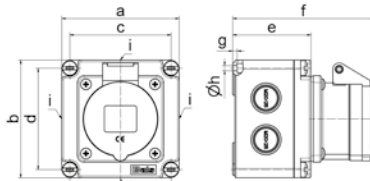

1 MB 120

Ampere	16	16	16	32	32	32
Poles	3	4	5	3	4	5
a	102,0	102,0	102,0	102,0	102,0	102,0
b	102,0	102,0	102,0	102,0	102,0	102,0
c	88,0	88,0	88,0	88,0	88,0	88,0
d	88,0	88,0	88,0	88,0	88,0	88,0
e	68,0	68,0	68,0	68,0	68,0	68,0
f	119,0	121,0	122,0	130,0	130,0	131,0
g	4,0	4,0	4,0	4,0	4,0	4,0
h	4,5	4,5	4,5	4,5	4,5	4,5
i	2xM20/25	2xM20/25	2xM20/25	2xM20/25	2xM20/25	2xM20/25
k	M20/25	M20/25	M20/25	M20/25	M20/25	M20/25
Cond. mm² min	1,5	1,5	1,5	2,5	2,5	2,5
Cond. mm² max	4	4	4	10	10	10

Surface Mounting Socket Outlet QUICK-CONNECT

- Cable entry 1x at top (open), 2x at bottom (closed)
- Base rotatable by 180°
- Nickel plated contacts
- Kontex contact
- Box terminals
- Protection degree IP44
- For screw terminal Surface Mounting Socket Outlets with PILOT, please add -P to the ref. no.



1124

Ampere	Poles	110V 50-60 Hz	230V 50-60 Hz	400V 50-60 Hz	500V 50-60 Hz	>50V 100-300Hz	>50V 301-500Hz	Quantity	Each
		3pol 4pol 5pol 4h 4h 4h	3pol 4pol 5pol 6h 9h 9h	3pol 4pol 5pol 9h 6h 6h	3pol 4pol 5pol 7h 7h 7h	3pol 4pol 5pol 10h 10h 10h	3pol 4pol 5pol 2h 2h 2h		
63	4			110415	110445			5	900
63	5			110383				5	945
Screw terminal:									
63	3	1106	1104	1107	11795	11345	11640	5	780
63	4	1125	1126	1127	1128	11221	11051	5	795
63	5	1129	1130	1124	11208	11429	1108	5	830

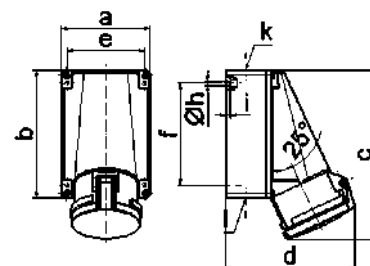

1 MB 4

Ampere	16	16	16
Poles	3	4	5
a	118,0	118,0	118,0
b	170,0	170,0	170,0
c	223,0	223,0	223,0
d	168,0	168,0	168,0
e	104,0	104,0	104,0
f	136,0	136,0	136,0
ø h	6,1	6,1	6,1
i	6,0	6,0	6,0
k	M40	M40	M40
l	M32/32	M32/32	M32/32
Cond. mm² min	6	6	6
Cond. mm² max	25	25	25

Surface Mounting Socket Outlet QUICK-CONNECT TE

- Screwless terminals
- Kontex contact
- High-temperature-resistant contact carrier
- Nickel plated contacts
- Box terminals
- With large wiring space
- Protection degree IP44

QUICK CONNECT



110487

Ampere	Poles	110V 50-60 Hz	230V 50-60 Hz	400V 50-60 Hz	500V 50-60 Hz	>50V 100-300Hz	>50V 301-500Hz	Quantity	Each
		3pol 4pol 5pol 4h 4h 4h	3pol 4pol 5pol 6h 9h 9h	3pol 4pol 5pol 9h 6h 6h	3pol 4pol 5pol 7h 7h 7h	3pol 4pol 5pol 10h 10h 10h	3pol 4pol 5pol 2h 2h 2h		
63	4			110486				1	1580
63	5			110487				1	1690

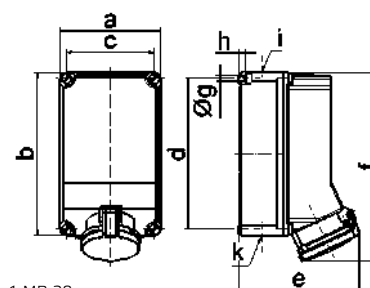

1 MB 28

Ampere	63	63
Poles	4	5
a	160,0	160,0
b	260,0	260,0
c	140,0	140,0
d	240,0	240,0
e	184,0	184,0
f	302,0	302,0
ø g	8,1	8,1
h	10,0	10,0
i	M40	M40
k	M32/40	M32/40
Cond. mm² min	6	6
Cond. mm² max	25	25

Surface Mounting Socket Outlet QUICK-CONNECT, straight

- Screwless terminals
- Kontex contact
- Cable entry 7x M20/25
- With large wiring space
- Protection degree IP67

QUICK CONNECT



110576

Ampere	Poles	110V 50-60 Hz	230V 50-60 Hz	400V 50-60 Hz	500V 50-60 Hz	>50V 100-300Hz	>50V 301-500Hz	Quantity	Each
		3pol 4pol 5pol 4h 4h 4h	3pol 4pol 5pol 6h 9h 9h	3pol 4pol 5pol 9h 6h 6h	3pol 4pol 5pol 7h 7h 7h	3pol 4pol 5pol 10h 10h 10h	3pol 4pol 5pol 2h 2h 2h		
16	3	110560	110559	110561				10	340
16	4	110563	110564	110562				10	355
16	5	110566	110567	110565				10	375
32	3	110569	110568	110570				10	415
32	4	110572	110571	110573				10	435
32	5	110575	110574	110576				10	470

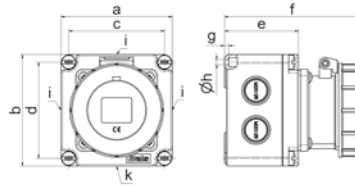

Ampere	16	16	16	32	32	32
Poles	3	4	5	3	4	5
a	102,0	102,0	102,0	102,0	102,0	102,0
b	102,0	102,0	102,0	102,0	102,0	102,0
c	88,0	88,0	88,0	88,0	88,0	88,0
d	88,0	88,0	88,0	88,0	88,0	88,0
e	68,0	68,0	68,0	68,0	68,0	68,0
f	124,0	125,0	124,0	134,0	134,0	134,0
g	4,0	4,0	4,0	4,0	4,0	4,0
ø h	4,5	4,5	4,5	4,5	4,5	4,5
i	2xM20/25	2xM20/25	2xM20/25	2xM20/25	2xM20/25	2xM20/25
k	M20/25	M20/25	M20/25	M20/25	M20/25	M20/25
Cond. mm² min	1,5	1,5	1,5	2,5	2,5	2,5
Cond. mm² max	4	4	4	10	10	10

1 MB 121

Surface Mounting Socket Outlet

- Screw terminals
- Cable entry 1x at top (open), with 16A 1x and with 32A 2x at bottom (closed)
- Base rotatable by 180°
- Protection degree IP67



11155

Ampere	Poles	110V 50-60 Hz	230V 50-60 Hz	400V 50-60 Hz	500V 50-60 Hz	>50V 100-300Hz	>50V 301-500Hz	Quantity	Each
		3pol 4pol 5pol 4h 4h 4h	3pol 4pol 5pol 6h 9h 9h	3pol 4pol 5pol 9h 6h 6h	3pol 4pol 5pol 7h 7h 7h	3pol 4pol 5pol 10h 10h 10h	3pol 4pol 5pol 2h 2h 2h		
16	3	11132	11133	11134	111320	111350	11027	10	210
16	4	11135	11136	11137	11138	11139	11140	10	265
16	5	11141	11142	11143	111343	111390	111342	10	300
32	3	11144	11145	11146				10	395
32	4	11147	11148	11149	11150	11151	11152	10	415
32	5	11153	11154	11155	111326	111432	11025	10	450

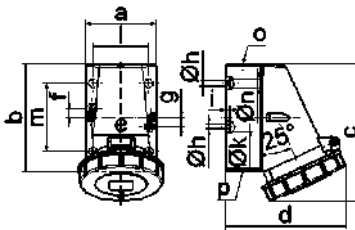

Ampere	16	16	16	32	32	32
Poles	3	4	5	3	4	5
a	64,0	75,0	75,0	83,0	83,0	83,0
b	87,0	100,0	100,0	126,0	126,0	126,0
c	115,0	130,0	130,0	160,0	160,0	160,0
d	103,0	110,0	115,0	129,0	129,0	135,0
e	51,0	59,0	59,0	68,0	68,0	68,0
f	20,0	11,0	11,0	11,0	11,0	11,0
g	20,0	-	-	-	-	-
ø h	4,1	5,1	5,1	5,5	5,5	5,5
i	4,5	4,5	4,5	6,5	6,5	6,5
ø k	8,0	10,0	10,0	12,0	12,0	12,0
l	-	-	-	65,0	65,0	65,0
m	-	-	-	80,0	80,0	80,0
ø n	-	-	-	10,0	10,0	10,0
o	M20	M20	M20	M25	M25	M25
p	f. M20	f. M20	f. M20	2xM25	2xM25	2xM25
Cond. mm² min	1,5	1,5	1,5	2,5	2,5	2,5
Cond. mm² max	4	4	4	10	10	10

1 MB 13

Surface Mounting Socket Outlet QUICK-CONNECT TE

- Screwless terminals
- Kontex contact
- High-temperature-resistant contact carrier
- Nickel plated contacts
- With large wiring space
- Protection degree IP67

QUICK CONNECT



110094

Ampere	Poles	110V 50-60 Hz	230V 50-60 Hz	400V 50-60 Hz	500V 50-60 Hz	>50V 100-300Hz	>50V 301-500Hz	Quantity	Each
		3pol 4pol 5pol 4h 4h 4h	3pol 4pol 5pol 6h 9h 9h	3pol 4pol 5pol 9h 6h 6h	3pol 4pol 5pol 7h 7h 7h	3pol 4pol 5pol 10h 10h 10h	3pol 4pol 5pol 2h 2h 2h		
16	3	11579	11492			110436		1	430
16	4		11630	11493	11155			1	450
16	5	11566		110094		110435		1	480

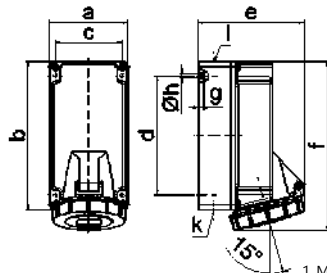

Ampere	16	16	16
Poles	3	4	5
a	90,0	90,0	90,0
b	170,0	170,0	170,0
c	77,0	77,0	77,0
d	137,5	137,5	137,5
e	108,0	115,0	122,0
f	191,5	191,5	195,0
g	6,5	6,5	6,5
ø h	5,5	5,5	5,5
i	M20	M20	M20
k	M20/25	M20/25	M20/25
Cond. mm² min	1,5	1,5	1,5
Cond. mm² max	4	4	4

1 MB 8

Surface Mounting Socket Outlet QUICK-CONNECT TE

- Screwless terminals
- Kontex contact
- High-temperature-resistant contact carrier
- Nickel plated contacts
- With large wiring space
- Protection degree IP67

QUICK CONNECT



110075

Ampere	Poles	110V 50-60 Hz	230V 50-60 Hz	400V 50-60 Hz	500V 50-60 Hz	>50V 100-300Hz	>50V 301-500Hz	Quantity	Each
		3pol 4pol 5pol 4h 4h 4h	3pol 4pol 5pol 6h 9h 9h	3pol 4pol 5pol 9h 6h 6h	3pol 4pol 5pol 7h 7h 7h	3pol 4pol 5pol 10h 10h 10h	3pol 4pol 5pol 2h 2h 2h		
32	3	11580	11496	11879				1	825
32	4		11555	11461	11156			1	830
32	5			110075				1	850

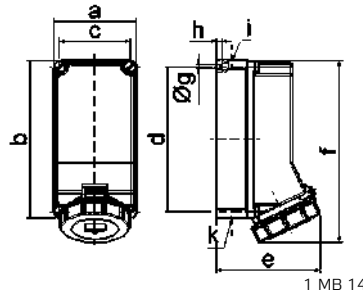

Ampere	32	32	32
Poles	3	4	5
a	118,0	118,0	118,0
b	225,0	225,0	225,0
c	101,0	101,0	101,0
d	208,0	208,0	208,0
e	143,0	143,0	149,0
f	255,0	255,0	255,0
ø g	6,5	6,5	6,5
h	8,0	8,0	8,0
i	2xM25	2xM25	2xM25
k	2xM25	2xM25	2xM25
Cond. mm² min	2,5	2,5	2,5
Cond. mm² max	10	10	10

Surface Mounting Socket Outlet

- Cable entry 1x at top (open), 1x at bottom (closed)
- Nickel plated contacts
- Base rotatable by 180°
- Kontex contact
- Box terminals
- Protection degree IP67
- For screw terminal Surface Mounting Socket Outlets with PILOT, please add -P to the ref. no.



1112

Ampere	Poles	110V 50-60 Hz	230V 50-60 Hz	400V 50-60 Hz	500V 50-60 Hz	>50V 100-300Hz	>50V 301-500Hz	Quantity	Each
		3pol 4pol 5pol 4h 4h 4h	3pol 4pol 5pol 6h 9h 9h	3pol 4pol 5pol 9h 6h 6h	3pol 4pol 5pol 7h 7h 7h	3pol 4pol 5pol 10h 10h 10h	3pol 4pol 5pol 2h 2h 2h		
63	4			110416	110446			5	960
63	5			110413				5	1005

Screw terminal:

Ampere	63	63	63	63
Poles	3	4	5	5
63	3	1156	1157	1158
63	4	1159	1160	1161
63	5	1163	1164	1112
				11017
				11368
				11126

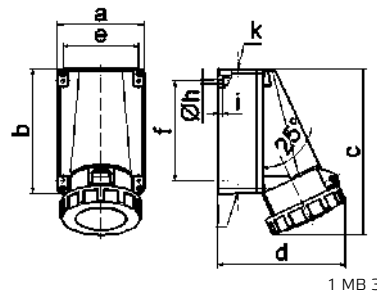

Ampere	63	63	63
Poles	3	4	5
a	118,0	118,0	118,0
b	170,0	170,0	170,0
c	228,0	228,0	228,0
d	176,0	176,0	176,0
e	104,0	104,0	104,0
f	136,0	136,0	136,0
ø h	6,1	6,1	6,1
i	6,0	6,0	6,0
k	M40	M40	M40
l	M32/32	M32/32	M32/32
Cond. mm² min	6	6	6
Cond. mm² max	25	25	25

Surface Mounting Socket Outlet

- Screw terminals
- Cable entry 1x M50 at top
- High-temperature-resistant contact carrier
- Kontex contact
- Nickel plated contacts
- Box terminals
- Protection degree IP67
- For Surface Mounting Socket Outlets with PILOT, please add -P to the ref. no.



11447

Ampere	Poles	110V 50-60 Hz	230V 50-60 Hz	400V 50-60 Hz	500V 50-60 Hz	>50V 100-300Hz	>50V 301-500Hz	Quantity	Each
		3pol 4pol 5pol 4h 4h 4h	3pol 4pol 5pol 6h 9h 9h	3pol 4pol 5pol 9h 6h 6h	3pol 4pol 5pol 7h 7h 7h	3pol 4pol 5pol 10h 10h 10h	3pol 4pol 5pol 2h 2h 2h		
125	3	11436	11437	11438	110452			1	1535
125	4	11439	11440	11441	11442	11443	11444	1	1965
125	5	11445	11446	11447			110468	1	2085

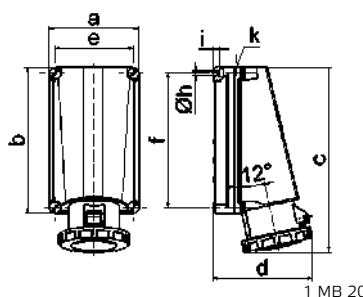

Ampere	125	125	125
Poles	3	4	5
a	160,0	160,0	160,0
b	260,0	260,0	260,0
c	330,0	330,0	330,0
d	168,0	168,0	168,0
e	140,0	140,0	140,0
f	240,0	240,0	240,0
ø h	8,3	8,3	8,3
i	10,0	10,0	10,0
k	M50	M50	M50
Cond. mm² min	25	25	25
Cond. mm² max	70	70	70

Surface Mounting Socket Outlet QUICK-CONNECT

- Screwless terminals
- Kontex contact
- High-temperature-resistant contact carrier
- Nickel plated contacts
- Box terminals
- With large wiring space
- Protection degree IP67

QUICK CONNECT



110485

		110V 50-60 Hz	230V 50-60 Hz	400V 50-60 Hz	500V 50-60 Hz	>50V 100-300Hz	>50V 301-500Hz	Quantity	g
Ampere	Poles	3pol 4pol 5pol 4h 4h 4h	3pol 4pol 5pol 6h 9h 9h	3pol 4pol 5pol 9h 6h 6h	3pol 4pol 5pol 7h 7h 7h	3pol 4pol 5pol 10h 10h 10h	3pol 4pol 5pol 2h 2h 2h		Each
63	4				110488			1	1620
63	5				110489			1	1730

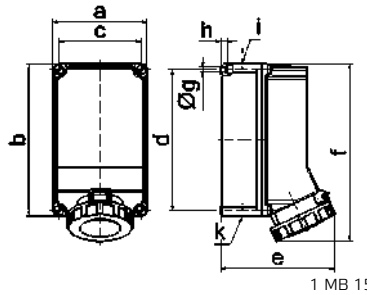

Ampere	63	63
Poles	4	5
a	160,0	160,0
b	260,0	260,0
c	140,0	140,0
d	240,0	240,0
e	195,0	195,0
f	304,0	304,0
ø g	8,1	8,1
h	10,0	10,0
i	M40	M40
k	M32/40	M32/40
Cond. mm² min	6	6
Cond. mm² max	25	25

1 MB 15

Surface Mounting Socket Outlet

- Screw terminals
- Kontex contact
- High-temperature-resistant contact carrier
- Nickel plated contacts
- Box terminals
- With large wiring space
- Protection degree IP67
- For Surface Mounting Socket Outlets with PILOT, please add -P to the ref. no.



11479

		110V 50-60 Hz	230V 50-60 Hz	400V 50-60 Hz	500V 50-60 Hz	>50V 100-300Hz	>50V 301-500Hz	Quantity	g
Ampere	Poles	3pol 4pol 5pol 4h 4h 4h	3pol 4pol 5pol 6h 9h 9h	3pol 4pol 5pol 9h 6h 6h	3pol 4pol 5pol 7h 7h 7h	3pol 4pol 5pol 10h 10h 10h	3pol 4pol 5pol 2h 2h 2h		Each
125	3				11476			1	2850
125	4				11477	11478		1	2900
125	5				11479			1	3195

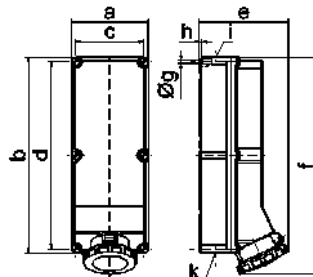

Ampere	125	125	125
Poles	3	4	5
a	180,0	180,0	180,0
b	460,0	460,0	460,0
c	160,0	160,0	160,0
d	440,0	440,0	440,0
e	208,0	208,0	208,0
f	510,0	510,0	510,0
ø g	8,3	8,3	8,3
h	6,5	6,5	6,5
i	M40	M40	M40
k	M40/50	M40/50	M40/50
Cond. mm² min	25	25	25
Cond. mm² max	70	70	70

1 MB 10

TK-Combi Socket QUICK-CONNECT

- Screwless terminals
- With terminals, with wiring (ready wired for installation)
- 109-QC with fuse base 5 x 20 mm
- With integrated domestic socket 16A/230V ~ (type F - German standard)
- Protection degree IP44

Accessories: see page 81

QUICK CONNECT

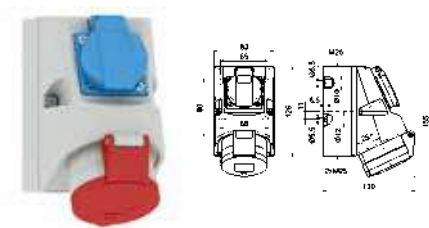

1010-QC

1 MB 122

2P+E Ampere	3P+E Poles	3+N+E Poles	230V 50-60 Hz	400V 50-60 Hz	Quantity	Each
16	5		3pol 6h 4pol 9h 5pol 9h	3pol 9h 4pol 6h 5pol 6h	10	

			109-QC		10	
--	--	--	---------------	--	----	--

			1010-QC		10	
--	--	--	----------------	--	----	--

TK-Combi Socket

- With terminals, without wiring
- With integrated domestic socket 16A/230V ~ (type F - German standard)
- Protection degree IP44

¹⁾ In the case of wiring using only one supply cable, use fuse base type 1862

Accessories: see page 81

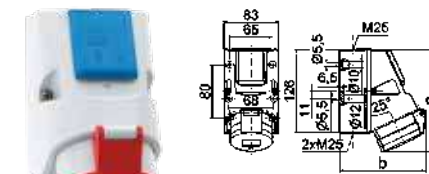

108

16A	32A
4p 5p	4p 5p
a 154 155 156 157	
b 127 130 130 136	

1 MB 17

2P+E Ampere	3P+E Poles	3+N+E Poles	230V 50-60 Hz	400V 50-60 Hz	Quantity	Each
16	4		3pol 6h 4pol 9h 5pol 9h	3pol 9h 4pol 6h 5pol 6h	10	400

			1012		10	400
--	--	--	-------------	--	----	-----

			107		10	410
--	--	--	------------	--	----	-----

			108		10	465
--	--	--	------------	--	----	-----

TK-Combi Socket

- With terminals, with wiring (ready wired for installation)
- With integrated domestic socket 16A/230V ~ (type F - German standard)
- Protection degree IP44

Accessories: see page 81

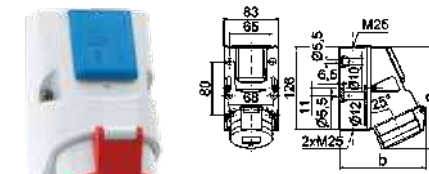

1010

16A	32A
4p 5p	4p 5p
a 154 155 156 157	
b 127 130 130 136	

1 MB 17

2P+E Ampere	3P+E Poles	3+N+E Poles	230V 50-60 Hz	400V 50-60 Hz	Quantity	Each
16	4		3pol 6h 4pol 9h 5pol 9h	3pol 9h 4pol 6h 5pol 6h	10	420

			1013		10	420
--	--	--	-------------	--	----	-----

			1010		10	460
--	--	--	-------------	--	----	-----

TK-Combi Socket

- With terminals, with wiring (ready wired for installation)
- With fuse base 5 x 20 mm DIN 41671 and fuse 6,3A
- With integrated domestic socket 16A/230V ~ (type F - German standard)
- Protection degree IP44

²⁾ 2x fuse 6,3A

Accessories: see page 81

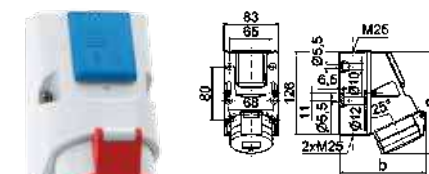

1011

16A	32A
4p 5p	4p 5p
a 154 155 156 157	
b 127 130 130 136	

1 MB 17

2P+E Ampere	3P+E Poles	3+N+E Poles	230V 50-60 Hz	400V 50-60 Hz	Quantity	Each
16	5		3pol 6h 4pol 9h 5pol 9h	3pol 9h 4pol 6h 5pol 6h	10	500

			109		10	500
--	--	--	------------	--	----	-----

			1020		10	515
--	--	--	-------------	--	----	-----

			1011		10	510
--	--	--	-------------	--	----	-----

TK-Combi Socket

- Belgian/French system
- With terminals, with wiring (ready wired for installation)
- With fuse base 5 x 20 mm DIN 41671 and fuse 6,3A
- With integrated domestic socket 16A/230V ~ (type F - German standard)
- Protection degree IP44

²⁾ 2x fuse 6,3A

Accessories: see page 81

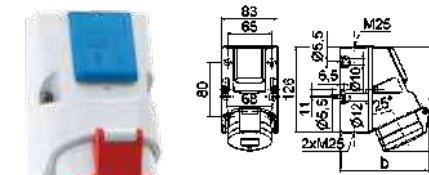

1018

16A	32A
4p 5p	4p 5p
a 154 155 156 157	
b 127 130 130 136	

1 MB 17

2P+E Ampere	3P+E Poles	3+N+E Poles	230V 50-60 Hz	400V 50-60 Hz	Quantity	Each
16 ²	4		3pol 6h 4pol 9h 5pol 9h	3pol 9h 4pol 6h 5pol 6h	10	450

			1017		10	450
--	--	--	-------------	--	----	-----

			1015		10	500
--	--	--	-------------	--	----	-----

			1019		10	515
--	--	--	-------------	--	----	-----

			1018		10	510
--	--	--	-------------	--	----	-----

Technical Information

- IEC 60309, EN 60309, VDE 0623
- Particularly suitable for harsh operating conditions, especially resistant to aggressive atmospheres

Surface Mounting Socket Outlet Quick-Connect TE

- Screw terminals
- Kontex contact
- For loopthrough
- High-temperature-resistant contact carrier
- Nickel plated contacts
- Protection degree IP44

Dimension drawing: see page 36/3 (1 MB 2)



11990



Amperage	Poles	230V 50-60 Hz	400V 50-60 Hz	500V 50-60 Hz	Quantity	Each
		3pol 6h 9h 9h	3pol 4pol 5pol 9h 6h 6h	3pol 4pol 5pol 7h 7h 7h		
16	4	11538	11485	11968	10	320
16	5	11972	11487	11973	10	330
32	3	11977	11978	11979	10	360
32	4	11983	11984	11985	10	380
32	5	11989	11990	11991	10	420

Surface Mounting Socket Outlet TE

- Screw terminals
- High-temperature-resistant contact carrier
- Kontex contact and box terminals
- Nickel plated contacts
- Protection degree IP44

Dimension drawing: see page 37/2 (1 MB 4)

11799



Amperage	Poles	230V 50-60 Hz	400V 50-60 Hz	500V 50-60 Hz	Quantity	Each
		3pol 6h 9h 9h	3pol 4pol 5pol 9h 6h 6h	3pol 4pol 5pol 7h 7h 7h		
63	3	11796			5	825
63	4		11797	11798	5	885
63	5		11799		5	900

Surface Mounting Socket Outlet QUICK-CONNECT TE

- Screwless terminals
- Kontex contact
- For loopthrough
- High-temperature-resistant contact carrier
- Nickel plated contacts
- Protection degree IP44



11451



Amperage	Poles	230V 50-60 Hz	400V 50-60 Hz	500V 50-60 Hz	Quantity	Each
		3pol 6h 9h 9h	3pol 4pol 5pol 9h 6h 6h	3pol 4pol 5pol 7h 7h 7h		
16	3	11448			1	410
16	4	11995	11449	110018	1	430
16	5		11451		1	450

Surface Mounting Socket Outlet QUICK-CONNECT TE

- Screwless terminals
- Kontex contact
- For loopthrough
- High-temperature-resistant contact carrier
- Nickel plated contacts
- Protection degree IP44



110000



Amperage	Poles	230V 50-60 Hz	400V 50-60 Hz	500V 50-60 Hz	Quantity	Each
		3pol 6h 9h 9h	3pol 4pol 5pol 9h 6h 6h	3pol 4pol 5pol 7h 7h 7h		
16	5		110098		1	650
32	3	11997			1	755
32	4	11998	11999	110019	1	770
32	5		110000		1	785

Surface Mounting Socket Outlet TE

- Screw terminals
- For loopthrough
- High-temperature-resistant contact carrier
- Kontex contact and box terminals
- Nickel plated contacts
- Protection degree IP44

Dimension drawing: see page 37/3 (1 MB 28)

11803



Amperage	Poles	230V 50-60 Hz	400V 50-60 Hz	500V 50-60 Hz	Quantity	Each
		3pol 6h 9h 9h	3pol 4pol 5pol 9h 6h 6h	3pol 4pol 5pol 7h 7h 7h		
63	3	11800			1	1600
63	4		11801	11802	1	1610
63	5		11803		1	1720

Technical Information

- IEC 60309, EN 60309, VDE 0623
- Particularly suitable for harsh operating conditions, especially resistant to aggressive atmospheres

Surface Mounting Socket Outlet QUICK-CONNECT TE

- Screwless terminals
- Kontex contact
- For loophthrough
- High-temperature-resistant contact carrier
- Nickel plated contacts
- Protection degree IP67

Dimension drawing: see page 38/3 (1 MB 8)



11455



Amperage	Poles	230V 50-60 Hz			400V 50-60 Hz			500V 50-60 Hz			Quantity	Each
		3pol 6h	4pol 9h	5pol 9h	3pol 9h	4pol 6h	5pol 6h	3pol 7h	4pol 7h	5pol 7h		
16	3	11452			110387			110388			1	430
16	4	11790			11453			110020			1	450
16	5				11455						1	480

Surface Mounting Socket Outlet QUICK-CONNECT TE

- Screwless terminals
- Kontex contact
- For loophthrough
- High-temperature-resistant contact carrier
- Nickel plated contacts
- Protection degree IP67

Dimension drawing: see page 39/1 (1 MB 14)



110017



Amperage	Poles	230V 50-60 Hz			400V 50-60 Hz			500V 50-60 Hz			Quantity	Each
		3pol 6h	4pol 9h	5pol 9h	3pol 9h	4pol 6h	5pol 6h	3pol 7h	4pol 7h	5pol 7h		
32	3	110014									1	825
32	4				110015			110016			1	845
32	5				110017						1	860

Surface Mounting Socket Outlet TE

- Screw terminals
- High-temperature-resistant contact carrier
- Kontex contact and box terminals
- Nickel plated contacts
- Protection degree IP67

Dimension drawing: see page 39/2 (1 MB 3)

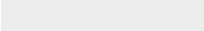

11825



Amperage	Poles	230V 50-60 Hz			400V 50-60 Hz			500V 50-60 Hz			Quantity	Each
		3pol 6h	4pol 9h	5pol 9h	3pol 9h	4pol 6h	5pol 6h	3pol 7h	4pol 7h	5pol 7h		
63	3	11822									5	900
63	4				11823			11824			5	920
63	5				11825						5	950

Surface Mounting Socket Outlet TE

- Screw terminals
- For loophthrough
- High-temperature-resistant contact carrier
- Kontex contact and box terminals
- Nickel plated contacts
- Protection degree IP67

Dimension drawing: see page 40/1 (1 MB 15)

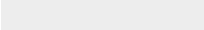

11829



Amperage	Poles	230V 50-60 Hz			400V 50-60 Hz			500V 50-60 Hz			Quantity	Each
		3pol 6h	4pol 9h	5pol 9h	3pol 9h	4pol 6h	5pol 6h	3pol 7h	4pol 7h	5pol 7h		
63	3	11826									1	1610
63	4				11827			11828			1	1620
63	5				11829						1	1640

Surface Mounting Socket Outlet TE

- Screw terminals
- High-temperature-resistant contact carrier
- Kontex contact and box terminals
- Nickel plated contacts
- Protection degree IP67

Dimension drawing: see page 40/2 (1 MB 10)

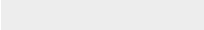

11815



Amperage	Poles	230V 50-60 Hz			400V 50-60 Hz			500V 50-60 Hz			Quantity	Each
		3pol 6h	4pol 9h	5pol 9h	3pol 9h	4pol 6h	5pol 6h	3pol 7h	4pol 7h	5pol 7h		
125	3	11812									1	2850
125	4				11813			11814			1	2900
125	5				11815						1	3195

1

2

3

4

5

6

7

Surface Mounting Socket Outlet

- With electrical PSC interlocking and additionally M20 at top
- High-temperature-resistant contact carrier
- Kontex contact
- Box terminals
- Protection degree IP44

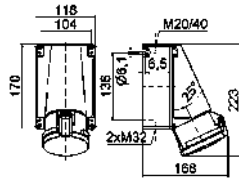

11787

1 MB 36

Amperage	Poles	400V 50-60 Hz			500V 50-60 Hz			Quantity	Each
		3pol 9h	4pol 6h	5pol 6h	3pol 7h	4pol 7h	5pol 7h		
63	4		11785				5	860	
63	5		11787				5	900	

Surface Mounting Socket Outlet

- With electrical PSC interlocking, Contactor and additionally M20 at top
- High-temperature-resistant contact carrier
- Nickel plated contacts
- Kontex contact
- Box terminals
- Protection degree IP44

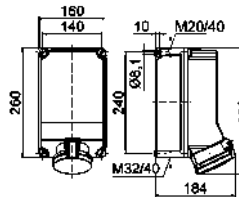

16873

1 MB 38

Amperage	Poles	400V 50-60 Hz			500V 50-60 Hz			Quantity	Each
		3pol 9h	4pol 6h	5pol 6h	3pol 7h	4pol 7h	5pol 7h		
63	4		16871				1	3140	
63	5		16873				1	2920	

Surface Mounting Socket Outlet

- With electrical PSC interlocking and additionally M20 at top
- High-temperature-resistant contact carrier
- Nickel plated contacts
- Kontex contact
- Box terminals
- Protection degree IP67

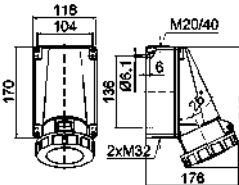

11038

1 MB 31

Amperage	Poles	400V 50-60 Hz			500V 50-60 Hz			Quantity	Each
		3pol 9h	4pol 6h	5pol 6h	3pol 7h	4pol 7h	5pol 7h		
63	4		11052				5	875	
63	5		11038				5	955	

Surface Mounting Socket Outlet

- With electrical PSC interlock, Contactor and additionally M20 at top
- High-temperature-resistant contact carrier
- Nickel plated contacts
- Kontex contact
- Box terminals
- Protection degree IP67

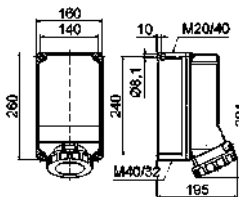

16072

1 MB 32

Amperage	Poles	400V 50-60 Hz			500V 50-60 Hz			Quantity	Each
		3pol 9h	4pol 6h	5pol 6h	3pol 7h	4pol 7h	5pol 7h		
63	4		16070				1		
63	5		16072				1	2915	

Surface Mounting Socket Outlet

- With electrical PSC interlocking and contactor
- High-temperature-resistant contact carrier
- Nickel plated contacts
- Kontex contact
- Box terminals
- Protection degree IP67

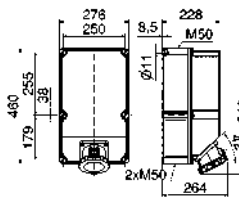

1676

30 MB 104

Amperage	Poles	400V 50-60 Hz			500V 50-60 Hz			Quantity	Each
		3pol 9h	4pol 6h	5pol 6h	3pol 7h	4pol 7h	5pol 7h		
125	4		1674				1	9100	
125	5		1676				1	9115	

1

2

3

4

5

6

7

Sockets

Surface Mounting Socket Outlets, fused

Technical Information

- IEC 60309-1/2, EN 60309, VDE 0623
 - Enclosure, window and socket insert made of high-grade plastic

Surface Mounting Socket Outlet

- With Din rail
- 5 modules
- Nickel plated contacts
- Protection degree IP44



15059

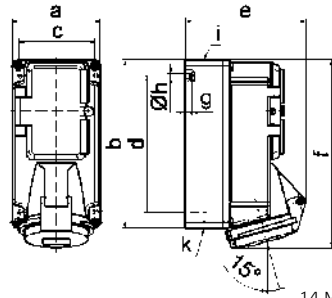

14 MB 3

Ampere Poles	16 3	16 4	16 5
a	90,0	90,0	90,0
b	170,0	170,0	170,0
c	77,0	77,0	77,0
d	137,5	137,5	137,5
e	118,0	114,0	121,0
f	188,5	188,5	190,0
g	6,0	6,0	6,0
ø h	5,5	5,5	5,5
i	M20	M20	M20
k	M20/25	M20/25	M20/25

Protection



- without fuse protection

16 3	15239	15019		1	505
16 4		15095	156	1	520
16 5		15096	15059	1	545

- with 1 or 3-pole fuse base D01



16 3	15382	1500		1	
16 4		1529	158	1	
16 5		1530	159	1	

- with 1 or 3-pole C-type MCB



16 3	15384	1504		1	
16 4		1533	1505	1	
16 5		1534	1506	1	890

- with RCCB
 25/0,03A 2-pole with 16A 3p
 40/0,03A 4-pole with 16A 4/5p



16 3	15386	15101		1	705
16 4		15102	15103	1	
16 5		15104	15105	1	810

Surface Mounting Socket Outlet

- With Din rail
- 5 modules
- Nickel plated contacts
- Protection degree IP67



15100

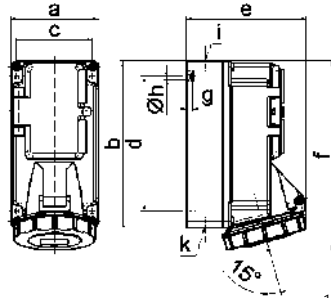

14 MB 6

Ampere Poles	16 3	16 4	16 5
a	90,0	90,0	90,0
b	170,0	170,0	170,0
c	77,0	77,0	77,0
d	137,5	137,5	137,5
e	108,0	115,0	121,0
f	191,5	191,5	191,5
g	6,0	6,0	6,0
ø h	5,5	5,5	5,5
i	M20	M20	M20
k	M20/25	M20/25	M20/25

Protection

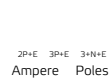

- without fuse protection

16 3	15240	15024		1	515
16 4		15097	15098	1	
16 5		15099	15100	1	580

- with 1 or 3-pole fuse base D01



16 3	15383	1501		1	
16 4		1531	1502	1	
16 5		1532	1503	1	

- with 1 or 3-pole C-type MCB



16 3	15385	1507		1	
16 4		1535	1508	1	
16 5		1536	1509	1	

- with RCCB
 25/0,03A 2-pole with 16A 3p
 40/0,03A 4-pole with 16A 4/5p



16 3	15387	15106		1	725
16 4		15107	15108	1	
16 5		15109	15110	1	835

Technical Information

- IEC 60309-1/2, EN 60309, VDE 0623
- Enclosure, window and socket insert made of high-grade plastic

Surface Mounting Socket Outlet

- With Din rail
- 5 modules
- Nickel plated contacts
- Protection degree IP44



1585

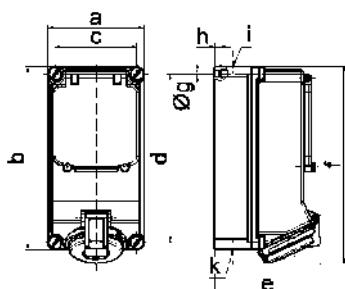

14 MB 13

Ampere Poles	16 4	16 5	32 3	32 4	32 5
a	118,0	118,0	118,0	118,0	118,0
b	225,0	225,0	225,0	225,0	225,0
c	101,0	101,0	101,0	101,0	101,0
d	208,0	208,0	208,0	208,0	208,0
e	123,0	130,0	134,0	134,0	141,0
f	242,0	242,0	250,0	250,0	250,0
g	6,5	6,5	6,5	6,5	6,5
ø h	8,0	8,0	8,0	8,0	8,0
i	2xM25	2xM25	2xM25	2xM25	2xM25
k	2xM25	2xM25	2xM25	2xM25	2xM25

Protection

			110V 50-60 Hz	230V 50-60 Hz	400V 50-60 Hz	500V 50-60 Hz	>50V 100-300Hz	>50V 301-500Hz		9
Ampere	Poles		3pol 4pol 5pol 4h 4h 4h	3pol 4pol 5pol 6h 9h 9h	3pol 4pol 5pol 9h 6h 6h	3pol 4pol 5pol 7h 7h 7h	3pol 4pol 5pol 10h 10h 10h	3pol 4pol 5pol 2h 2h 2h	Quantity	Each

- without fuse protection

16	4			1582	15044				1	
16	5			1583					1	840
32	3	15029	15030						1	675
32	4			1584	15045				1	
32	5			1585					1	930

- with fuse base
D01 for 16A
D02 for 32A



16	4			1586					1	
16	5			1587					1	1035
32	3		1537						1	
32	4			1588					1	
32	5			1589					1	1220

- with 3-pole C-type MCB



16	4			1594					1	1185
16	5			1595					1	
32	4			1596					1	
32	5			1597					1	1310

- with RCCB 40/0,03A 4-pole



16	4			15125					1	
16	5			15076					1	1275
32	4			15126					1	1440
32	5			15077					1	1355

Technical Information

- IEC 60309-1/2, EN 60309, VDE 0623
- Enclosure, window and socket insert made of high-grade plastic

Surface Mounting Socket Outlet

- With Din rail
- 5 modules
- Nickel plated contacts
- Protection degree IP67



15112

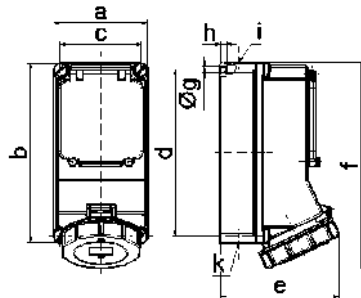

14 MB 12

Ampere Poles	16 4	16 5	32 3	32 4	32 5
a	118,0	118,0	118,0	118,0	118,0
b	225,0	225,0	225,0	225,0	225,0
c	101,0	101,0	101,0	101,0	101,0
d	208,0	208,0	208,0	208,0	208,0
e	127,0	134,0	143,0	143,0	149,0
f	245,0	245,0	255,0	255,0	255,0
g	6,5	6,5	6,5	6,5	6,5
ø h	8,0	8,0	8,0	8,0	8,0
i	2xM25	2xM25	2xM25	2xM25	2xM25
k	2xM25	2xM25	2xM25	2xM25	2xM25

Protection

Protection	Ampere	Poles	110V 50-60 Hz			230V 50-60 Hz			400V 50-60 Hz			500V 50-60 Hz			>50V 100-300Hz			>50V 301-500Hz			Quantity	Each
			3pol 4h	4pol 4h	5pol 4h	3pol 6h	4pol 9h	5pol 9h	3pol 9h	4pol 6h	5pol 6h	3pol 7h	4pol 7h	5pol 7h	3pol 10h	4pol 10h	5pol 10h	3pol 2h	4pol 2h	5pol 2h		
	16	4																		1	950	
	16	5																		1	980	
- without fuse protection	32	3	15388			15352														1	1000	
	32	4								15111	15177									1	1020	
	32	5								15112										1	1160	
- with fuse base D01 for 16A D02 for 32A	16	4								15113										1	1150	
	16	5								15114										1	1180	
	32	3				1565														1	1200	
	32	4								15115										1	1220	
	32	5								15116										1	1360	
- with 3-pole C-type MCB	16	4								15121										1	1250	
	16	5								15122										1	1280	
	32	4								15123										1	1320	
	32	5								15124										1	1460	
- with RCCB 40/0,03A 4-pole	16	4								15127										1	1410	
	16	5								15078										1	1440	
	32	4								15128										1	1480	
	32	5								15079										1	1520	

Technical Information

- IEC 60309-1/2, EN 60309, VDE 0623
- Enclosure, window and socket insert made of high-grade plastic

Surface Mounting Socket Outlet

- With Din rail
- 7 modules
- 63A with box terminals and Kontex contact
- Nickel plated contacts
- Protection degree IP44
- Products with PILOT please add "P" to the ref. no.



15036

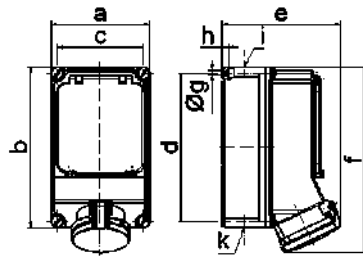

14 MB 14

Ampere Poles	32 4	32 5	63 3	63 4	63 5
a	160,0	160,0	160,0	160,0	160,0
b	260,0	260,0	260,0	260,0	260,0
c	140,0	140,0	140,0	140,0	140,0
d	240,0	240,0	240,0	240,0	240,0
e	160,0	168,0	185,0	185,0	185,0
f	286,0	286,0	303,0	303,0	303,0
ø g	8,1	8,1	8,1	8,1	8,1
h	10,0	10,0	10,0	10,0	10,0
i	M40	M40	M40	M40	M40
k	M32/40	M32/40	M32/40	M32/40	M32/40

Protection

3P+E Ampere	3P+E Poles	3P+N+E Poles	110V 50-60 Hz	230V 50-60 Hz	400V 50-60 Hz	500V 50-60 Hz	>50V 100-300Hz	>50V 301-500Hz	Quantity	Each									
32	4		3pol 4h	4pol 4h	5pol 4h	3pol 6h	4pol 6h	5pol 6h	3pol 7h	4pol 7h	5pol 7h	3pol 10h	4pol 10h	5pol 10h	3pol 2h	4pol 2h	5pol 2h	9	

- without fuse protection

32	4																		1	
32	5																		1	
63	3																		1	
63	4																		1	
63	5																		1	2165

- with fuse base D02



32	4																		1	
32	5																		1	
63	3																		1	
63	4																		1	
63	5																		1	2165

- with 3-pole C-type MCB



32	4																		1	
32	5																		1	
63	4																		1	
63	5																		1	

- with RCCB
40/0,03A 4-pole for 32A
63/0,03A 4-pole for 63A



32	4																		1	
32	5																		1	1915
63	4																		1	
63	5																		1	2251

Sockets

Surface Mounting Socket Outlets, fused

Technical Information

- IEC 60309-1/2, EN 60309, VDE 0623
- Enclosure, window and socket insert made of high-grade plastic

Surface Mounting Socket Outlet

- With Din rail
- 7 modules
- 63A with box terminals and Kontex contact
- Nickel plated contacts
- Protection degree IP67
- Products with PILOT please add "P" to the ref. no.



15001

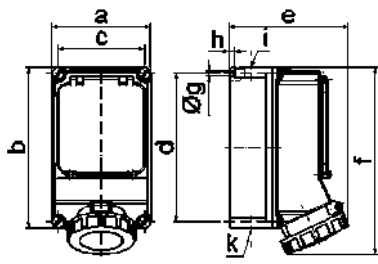

14 MB 11

Ampere Poles	32 4	32 5	63 4	63 5
a	160,0	160,0	160,0	160,0
b	260,0	260,0	260,0	260,0
c	140,0	140,0	140,0	140,0
d	240,0	240,0	240,0	240,0
e	172,0	174,0	195,0	195,0
f	293,0	294,0	304,0	304,0
ø g	8,1	8,1	8,1	8,1
h	10,0	10,0	10,0	10,0
i	M40	M40	M40	M40
k	M32/40	M32/40	M32/40	M32/40

Protection

2P+E Ampere	3P+E Poles	3+N+E Poles	110V 50-60 Hz 3pol 4pol 5pol 4h 4h 4h	230V 50-60 Hz 3pol 4pol 5pol 6h 9h 9h	400V 50-60 Hz 3pol 4pol 5pol 9h 6h 6h	500V 50-60 Hz 3pol 4pol 5pol 7h 7h 7h	>50V 100-300Hz 3pol 4pol 5pol 10h 10h 10h	>50V 301-500Hz 3pol 4pol 5pol 2h 2h 2h	Quantity	Each
----------------	---------------	----------------	--	--	--	--	--	---	----------	------

- without fuse protection

32	4				1598	15174			1	
32	5				1599				1	
63	4				15000	15175			1	1850
63	5				15001				1	1950

- with fuse base D02



32	4				15133				1	
32	5				15134				1	
63	4				15083				1	
63	5				15013				1	

- with 3-pole C-type MCB



32	4				15142				1	
32	5				15143				1	
63	4				15144				1	
63	5				15145				1	

- with RCCB
40/0,03A 4-pole for 32A
63/0,03A 4-pole for 63A



32	4				15149				1	
32	5				15150				1	1970
63	4				15151				1	
63	5				15080				1	2315

Technical Information

- IEC 60309-1/2, EN 60309, VDE 0623
- Enclosure, window and socket insert made of high-grade plastic

Surface Mounting Socket Outlet

- With Din rail
- 8 modules
- Kontex contact
- Nickel plated contacts
- Box terminals
- Protection degree IP44
- Products with PILOT please add "P" to the ref. no.



15038

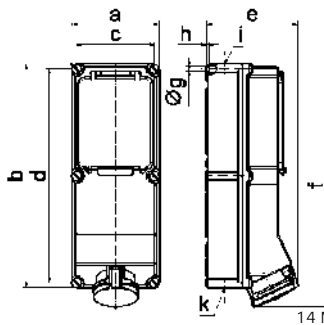

Ampere Poles	63 4	63 5
a	180,0	180,0
b	460,0	460,0
c	160,0	160,0
d	440,0	440,0
e	182,0	182,0
f	498,0	498,0
ø g	8,3	8,3
h	6,5	6,5
i	M40	M40
k	M32/40	M32/40

Protection

			110V 50-60 Hz	230V 50-60 Hz	400V 50-60 Hz	500V 50-60 Hz	>50V 100-300Hz	>50V 301-500Hz		9
3pole 4pole 5pole	3pole 4pole 5pole	3pole 4pole 5pole	4h 4h 4h	6h 9h 9h	9h 6h 6h	3pole 4pole 5pole	3pole 4pole 5pole	3pole 4pole 5pole	Quantity	Each

- without fuse protection

63	4	15155	15156	1	3800
63	5	15038		1	2830

- with load-break switch NH00



63	4	15152	15153	1	
63	5	15154		1	3390

- with RCCB
63/0,03A 4-pole for 63A



63	4	15161		1	
63	5	15162		1	

- with RCCB
63/0,03A 4-pole for 63A



63	4	15163		1	
63	5	15164		1	

Sockets

Surface Mounting Socket Outlets, fused

Technical Information

- IEC 60309-1/2, EN 60309, VDE 0623
 - Enclosure and socket insert made of high-grade plastic

Surface Mounting Socket Outlet

- With Din rail
- 8 modules
- Kontex contact
- Box terminals
- Nickel plated contacts
- Protection degree IP67
- Products with PILOT please add "P" to the ref. no.



15047

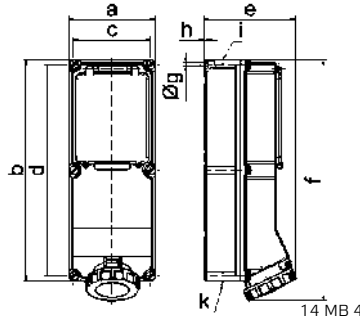

Ampere Poles	63 3	63 4	63 5	125 4	125 5
a	180,0	180,0	180,0	180,0	180,0
b	460,0	460,0	460,0	460,0	460,0
c	160,0	160,0	160,0	160,0	160,0
d	440,0	440,0	440,0	440,0	440,0
e	191,0	191,0	191,0	210,0	210,0
f	500,0	500,0	500,0	512,0	512,0
ø g	8,3	8,3	8,3	8,3	8,3
h	6,5	6,5	6,5	6,5	6,5
i	M40	M40	M40	M40	M40
k	M32/40	M32/40	M32/40	M40/50	M40/50

Protection

Amperes	2P+E	3P+E	3+N+E	110V 50-60 Hz	230V 50-60 Hz	400V 50-60 Hz	500V 50-60 Hz	>50V 100-300Hz	>50V 301-500Hz	Quantity	Each
63	3			3pol 4pol 5pol 4h 4h 4h	3pol 4pol 5pol 6h 9h 9h	3pol 4pol 5pol 9h 6h 6h	3pol 4pol 5pol 7h 7h 7h	3pol 4pol 5pol 10h 10h 10h	3pol 4pol 5pol 2h 2h 2h	9	

- without fuse protection

63	3	15072								1	
63	4					1580	15157			1	2890
63	5					15047					
125	4						15158	15159		1	
125	5						15160			1	3800

- with RCCB
 63/0,03A 4-pole for 63A
 125/0,3A 4-pole for 125A



63	4						15165			1	
63	5						15166			1	3285
125	4						15169			1	
125	5						15170			1	3960

- with RCCB
 63/0,3A 4-pole for 63A
 125/0,5A 4-pole for 125A



63	4						15167			1	
63	5						15168			1	
125	4						15171			1	
125	5						15075			1	

Surface Mounting Socket Outlet

- Kontex contact
- Box terminals
- Nickel plated contacts
- Protection degree IP67
- Products with PILOT please add "P" to the ref. no.



15009

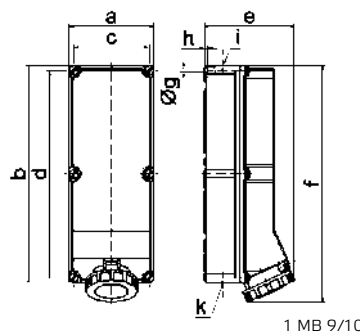

Ampere Poles	63 4	63 5	125 4	125 5
a	180,0	180,0	180,0	180,0
b	460,0	460,0	460,0	460,0
c	160,0	160,0	160,0	160,0
d	440,0	440,0	440,0	440,0
e	191,0	191,0	210,0	210,0
f	500,0	500,0	512,0	512,0
ø g	8,3	8,3	8,3	8,3
h	6,5	6,5	6,5	6,5
i	M40	M40	M40	M40
k	M32/40	M32/40	M40/50	M40/50

Protection

Amperes	2P+E	3P+E	3+N+E	110V 50-60 Hz	230V 50-60 Hz	400V 50-60 Hz	500V 50-60 Hz	>50V 100-300Hz	>50V 301-500Hz	Quantity	Each
63	4			3pol 4pol 5pol 4h 4h 4h	3pol 4pol 5pol 6h 9h 9h	3pol 4pol 5pol 9h 6h 6h	3pol 4pol 5pol 7h 7h 7h	3pol 4pol 5pol 10h 10h 10h	3pol 4pol 5pol 2h 2h 2h	9	

- with load-break switch NH00



63	4						15006	15042		1	
63	5						15007			1	3455
125	4						15008	15043		1	3715
125	5						15009			1	4030

Technical Information

- IEC 60309-1/2, EN 60309, VDE 0623
- Enclosure and socket insert made of high-grade plastic

Surface Mounting Socket Outlet

- Switched
- Lockable in 0-position
- With mechanical double interlocking
- Nickel plated contacts
- Protection degree IP44
- as switchable version available on request



110V 50-60 Hz	230V 50-60 Hz	400V 50-60 Hz	500V 50-60 Hz	>50V 100-300Hz	>50V 301-500Hz
3pol 4pol 5pol 4h 4h 4h	3pol 4pol 5pol 6h 9h 9h	3pol 4pol 5pol 9h 6h 6h	3pol 4pol 5pol 7h 7h 7h	3pol 4pol 5pol 10h 10h 10h	3pol 4pol 5pol 2h 2h 2h

Quantity	Each
9	

16	3	16008	1619			1	575
16	4		1641	1610	1616	1	605
16	5		1642	1611		1	615



1611

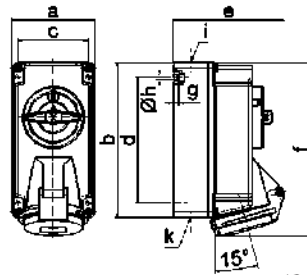

12 MB 3

Ampere Poles	16 3	16 4	16 5
a	90,0	90,0	90,0
b	170,0	170,0	170,0
c	77,0	77,0	77,0
d	137,5	137,5	137,5
e	108,0	114,0	121,0
f	188,5	188,5	190,0
g	6,0	6,0	6,0
ø h	5,5	5,5	5,5
i	M20	M20	M20
k	M20/25	M20/25	M20/25

Surface Mounting Socket Outlet

- Switched
- Lockable in 0-position
- With mechanical double interlocking
- Nickel plated contacts
- Protection degree IP44
- as switchable version available on request



110V 50-60 Hz	230V 50-60 Hz	400V 50-60 Hz	500V 50-60 Hz	>50V 100-300Hz	>50V 301-500Hz
3pol 4pol 5pol 4h 4h 4h	3pol 4pol 5pol 6h 9h 9h	3pol 4pol 5pol 9h 6h 6h	3pol 4pol 5pol 7h 7h 7h	3pol 4pol 5pol 10h 10h 10h	3pol 4pol 5pol 2h 2h 2h

Quantity	Each
9	

16	4	16058	16038	16064		1	980
16	5		16039			1	1010
32	3	16123	16097			1	1160
32	4		16060	16042	16066	1	1205
32	5			16043		1	1210



16039

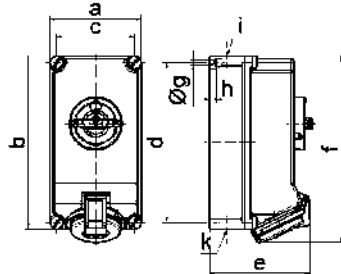

12 MB 24

Ampere Poles	16 4	16 5	32 3	32 4	32 5
a	118,0	118,0	118,0	118,0	118,0
b	225,0	225,0	225,0	225,0	225,0
c	101,0	101,0	101,0	101,0	101,0
d	208,0	208,0	208,0	208,0	208,0
e	126,0	134,0	137,0	137,0	144,0
f	242,0	242,0	251,0	251,0	251,0
ø g	6,5	6,5	6,5	6,5	6,5
h	8,0	8,0	8,0	8,0	8,0
i	2xM25	2xM25	2xM25	2xM25	2xM25
k	2xM25	2xM25	2xM25	2xM25	2xM25

Surface Mounting Socket Outlet

- Switched
- Lockable in 0-position
- With mechanical double interlocking
- Nickel plated contacts
- Box terminals
- Protection degree IP44
- Products with PILOT please add "P" to the ref. no.
- as switchable version available on request



110V 50-60 Hz	230V 50-60 Hz	400V 50-60 Hz	500V 50-60 Hz	>50V 100-300Hz	>50V 301-500Hz
3pol 4pol 5pol 4h 4h 4h	3pol 4pol 5pol 6h 9h 9h	3pol 4pol 5pol 9h 6h 6h	3pol 4pol 5pol 7h 7h 7h	3pol 4pol 5pol 10h 10h 10h	3pol 4pol 5pol 2h 2h 2h

Quantity	Each
9	

63	3	16093	16956			1	2025
63	4		16933	16605	16827	1	2150
63	5			16603	16721	1	2245



16603

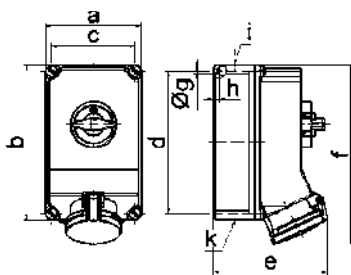

12 MB 30

Ampere Poles	63 3	63 4	63 5
a	160,0	160,0	160,0
b	260,0	260,0	260,0
c	140,0	140,0	140,0
d	240,0	240,0	240,0
e	184,0	184,0	184,0
f	302,0	302,0	302,0
ø g	8,1	8,1	8,1
h	10,0	10,0	10,0
i	M40	M40	M40
k	M32/40	M32/40	M32/40

Sockets

Surface Mounting Socket Outlets, switched, interlocked

Technical Information

- IEC 60309-1/2, EN 60309, VDE 0623
 - Enclosure and socket insert made of high-grade plastic

Surface Mounting Socket Outlet

- Switched
- Lockable in 0-position
- With mechanical double interlocking
- Nickel plated contacts
- Protection degree IP67
- as switchable version available on request

Ampere	Poles	110V	230V	400V	500V	>50V	>50V	Quantity	g	Each
		50-60 Hz	50-60 Hz	50-60 Hz	50-60 Hz	100-300Hz	301-500Hz			
		3pol 4pol 5pol 4h 4h 4h	3pol 4pol 5pol 6h 9h 9h	3pol 4pol 5pol 9h 6h 6h	3pol 4pol 5pol 7h 7h 7h	3pol 4pol 5pol 10h 10h 10h	3pol 4pol 5pol 2h 2h 2h			
16	3	16138	160048	160056				1	600	
16	4		160053	160049	160057			1	625	
16	5		160055	160052	160058			1	640	



160052

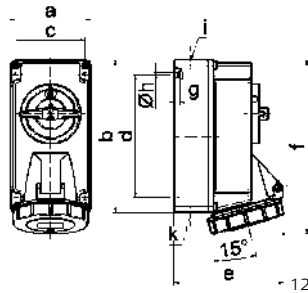

Ampere Poles	16 3	16 4	16 5
a	90,0	90,0	90,0
b	170,0	170,0	170,0
c	77,0	77,0	77,0
d	137,5	137,5	137,5
e	108,0	115,0	121,0
f	191,5	191,5	191,5
g	6,0	6,0	6,0
ø h	5,5	5,5	5,5
i	M20	M20	M20
k	M20/25	M20/25	M20/25

Surface Mounting Socket Outlet

- Switched
- Lockable in 0-position
- With mechanical double interlocking
- Nickel plated contacts
- Protection degree IP67
- as switchable version available on request

Ampere	Poles	110V	230V	400V	500V	>50V	>50V	Quantity	g	Each
		50-60 Hz	50-60 Hz	50-60 Hz	50-60 Hz	100-300Hz	301-500Hz			
		3pol 4pol 5pol 4h 4h 4h	3pol 4pol 5pol 6h 9h 9h	3pol 4pol 5pol 9h 6h 6h	3pol 4pol 5pol 7h 7h 7h	3pol 4pol 5pol 10h 10h 10h	3pol 4pol 5pol 2h 2h 2h			
16	4		16059	16040	16065			1	1020	
16	5			16041				1	1050	
32	3	16124	16104					1	1275	
32	4		16875	160178	160179			1	1255	
32	5			160177				1	1325	



16041

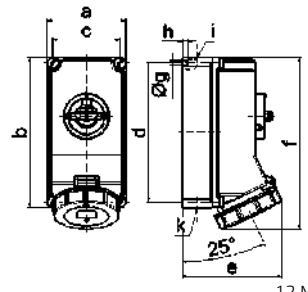

Ampere Poles	16 4	16 5	32 3	32 4	32 5
a	118,0	118,0	118,0	118,0	118,0
b	225,0	225,0	225,0	225,0	225,0
c	101,0	101,0	101,0	101,0	101,0
d	208,0	208,0	208,0	208,0	208,0
e	127,0	134,0	143,0	143,0	149,0
f	245,0	245,0	255,0	255,0	255,0
ø g	6,5	6,5	6,5	6,5	6,5
h	8,0	8,0	8,0	8,0	8,0
i	2xM25	2xM25	2xM25	2xM25	2xM25
k	2xM25	2xM25	2xM25	2xM25	2xM25

Surface Mounting Socket

- Switched
- Lockable in 0-position
- With mechanical double interlocking
- Kontex contact
- Nickel plated contacts
- Box terminals
- Protection degree IP67
- Products with PILOT please add "P" to the ref. no.
- as switchable version available on request

Ampere	Poles	110V	230V	400V	500V	>50V	>50V	Quantity	g	Each
		50-60 Hz	50-60 Hz	50-60 Hz	50-60 Hz	100-300Hz	301-500Hz			
		3pol 4pol 5pol 4h 4h 4h	3pol 4pol 5pol 6h 9h 9h	3pol 4pol 5pol 9h 6h 6h	3pol 4pol 5pol 7h 7h 7h	3pol 4pol 5pol 10h 10h 10h	3pol 4pol 5pol 2h 2h 2h			
63	3	16125	16606					1	2135	
63	4		16934	16604	16828			1	2200	
63	5			16602	160290			1	2300	



16602

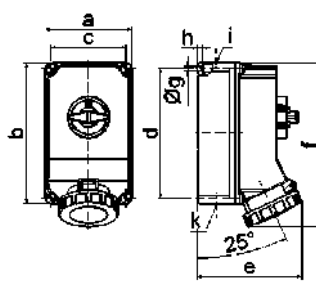

Ampere Poles	63 3	63 4	63 5
a	160,0	160,0	160,0
b	260,0	260,0	260,0
c	140,0	140,0	140,0
d	240,0	240,0	240,0
e	195,0	195,0	195,0
f	304,0	304,0	304,0
ø g	8,1	8,1	8,1
h	10,0	10,0	10,0
i	M40	M40	M40
k	M32/40	M32/40	M32/40

Technical Information

- IEC 60309-1/2, EN 60309, VDE 0623
- Enclosure and socket insert made of high-grade plastic

Surface Mounting Socket Outlet

- Switched
- Lockable in 0-position
- With mechanical double interlocking
- Kontex contact
- Nickel plated contacts
- Box terminals
- Protection degree IP67
- as switchable version available on request



110V
50-60 Hz
3pol 4pol 5pol
4h 4h 4h

230V
50-60 Hz
3pol 4pol 5pol
6h 9h 9h

400V
50-60 Hz
3pol 4pol 5pol
9h 6h 6h

500V
50-60 Hz
3pol 4pol 5pol
7h 7h 7h

>50V
100-300Hz
3pol 4pol 5pol
10h 10h 10h

>50V
301-500Hz
3pol 4pol 5pol
2h 2h 2h

Quantity Each

125	3	16620		1	3605
125	4	16930	16621	16831	1 3635
125	5		16622		1 3950



16622

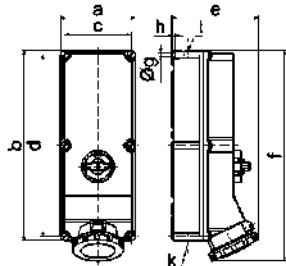

12 MB 5

Ampere Poles	125 3	125 4	125 5
a	180,0	180,0	180,0
b	460,0	460,0	460,0
c	160,0	160,0	160,0
d	440,0	440,0	440,0
e	208,0	208,0	208,0
f	510,0	510,0	510,0
ø g	8,3	8,3	8,3
h	6,5	6,5	6,5
i	M40	M40	M40
k	M40/50	M40/50	M40/50

Surface Mounting Socket Outlet

- Switched
- Lockable in 0-position
- With mechanical double interlocking
- Kontex contact
- Nickel plated contacts
- Box terminals
- Terminals 5x 50mm²
- Protection degree IP67

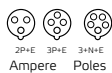

110V
50-60 Hz
3pol 4pol 5pol
4h 4h 4h

230V
50-60 Hz
3pol 4pol 5pol
6h 9h 9h

400V
50-60 Hz
3pol 4pol 5pol
9h 6h 6h

500V
50-60 Hz
3pol 4pol 5pol
7h 7h 7h

>50V
100-300Hz
3pol 4pol 5pol
10h 10h 10h

>50V
301-500Hz
3pol 4pol 5pol
2h 2h 2h

Quantity Each

125	5	51010578			
-----	---	-----------------	--	--	--

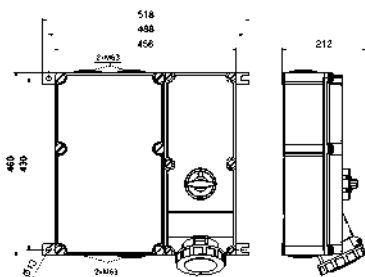

Z131190

Sockets

Surface Mounting Socket Outlets, switched, fused

Technical Information

- IEC 60309-1/2, EN 60309, VDE 0623
- Enclosure, window and socket insert made of high-grade plastic

Surface Mounting Socket Outlet

- Switched
- Lockable in 0-position
- With Din rail
- 6 modules for 16A and 32A, 8 modules for 63A
- 63A with box terminals and Kontex contact
- Nickel plated contacts
- Protection degree IP44
- Products with PILOT please add "P" to the ref. no.



17060

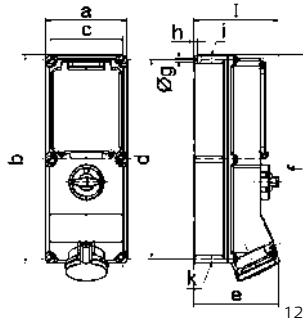

Ampere Poles	16 4	16 5	32 4	32 5	63 4	63 5
a	134,0	134,0	134,0	134,0	180,0	180,0
b	365,0	365,0	365,0	365,0	460,0	460,0
c	117,0	117,0	117,0	117,0	160,0	160,0
d	348,0	348,0	348,0	348,0	440,0	440,0
e	135,0	141,0	146,0	152,0	184,0	184,0
f	382,0	382,0	391,0	391,0	500,0	500,0
ø g	6,5	6,5	6,5	6,5	8,3	8,3
h	8,0	8,0	8,0	8,0	6,5	6,5
i	M25/32	M25/32	M32/40	M32/40	M40	M40
k	M25/32	M25/32	M32/40	M32/40	M32/40	M32/40
l	156,0	156,0	156,0	156,0	189,0	189,0

12 MB 21

Protection



Amperes	Poles	110V 50-60 Hz	230V 50-60 Hz	400V 50-60 Hz	500V 50-60 Hz	>50V 100-300Hz	>50V 301-500Hz	Quantity	Each
16	4		17275	17055	17337			1	
16	5			17056				1	1630
- without fuse protection	32		17276	17057	17338			1	1700
	32			17058				1	1750
	63		17277	17059	17339			1	
	63			17060	17847			1	
- with fuse base D01 for 16A D02 for 32A and 63A	16		17027	1775				1	1775
	16			1776				1	1830
	32		17028	1777				1	
	32			1778				1	2160
	63		176	174				1	
	63		177	175				1	3495
- with fuse base DII for 16A DIII for 32A and 63A	16		17032	1783	17233			1	
	16			1784				1	
	32		17033	1785	17234			1	
	32			1786				1	2230
	63		1734	178	1736			1	
	63		1735	179				1	3795
- with 3-pole C-type MCB	16		17280	17281				1	
	16			17282				1	1960
	32		17283	17284				1	
	32			17285				1	
	63		17286	17287				1	
	63			17288				1	
- with C-type MCB and RCCB 40/0,03A for 16A and 32A	16		17298	17299				1	
	16			17300				1	2350
	32		17301	17302				1	
- with D02 and RCCB 63/0,03A for 63A	32			17303				1	2675
	63		17304	17305				1	
	63			17306				1	3955
- with load-break switch NH00	63		17037	1793	17335			1	
	63			1794				1	

Technical Information

- IEC 60309-1/2, EN 60309, VDE 0623
- Enclosure, window and socket insert made of high-grade plastic

Surface Mounting Socket Outlet

- Switched
- Lockable in 0-position
- With Din rail
- 6 modules for 16A and 32A, 8 modules for 63A
- 63A with box terminals and Kontex contact
- Nickel plated contacts
- Protection degree IP67
- Products with PILOT please add "P" to the ref. no.

17066

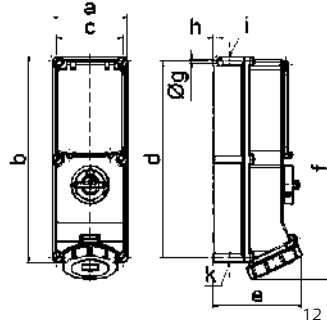

Ampere Poles	16 4	16 5	32 4	32 5	63 4	63 5
a	134,0	134,0	134,0	134,0	180,0	180,0
b	365,0	365,0	365,0	365,0	460,0	460,0
c	117,0	117,0	117,0	117,0	160,0	160,0
d	348,0	348,0	348,0	348,0	440,0	440,0
e	136,0	143,0	152,0	158,0	191,0	191,0
f	389,0	389,0	399,0	399,0	500,0	500,0
ø g	6,5	6,5	6,5	6,5	8,3	8,3
h	8,0	8,0	8,0	8,0	6,5	6,5
i	M25/32	M25/32	M32/40	M32/40	M40	M40
k	M25/32	M25/32	M32/40	M32/40	M32/40	M32/40

Protection



110V 50-60 Hz

230V 50-60 Hz

400V 50-60 Hz

500V 50-60 Hz

>50V 100-300Hz

>50V 301-500Hz



9

Ampere Poles

3pol 4pol 5pol 4h 4h 4h

3pol 4pol 5pol 6h 9h 9h

3pol 4pol 5pol 9h 6h 6h

3pol 4pol 5pol 7h 7h 7h

3pol 4pol 5pol 10h 10h 10h

3pol 4pol 5pol 2h 2h 2h

Quantity Each

- without fuse protection

16	4	17278	17061	17340	1	
16	5		17062		1	1675
32	4	17162	17063	17341	1	
32	5		17064		1	1800
63	4	17279	17065	17342	1	
63	5		17066		1	3280

- with fuse base D01 for 16A D02 for 32A and 63A



16	4	17029	1779		1	
16	5		1780		1	
32	4	17030	1781		1	
32	5		1782		1	
63	4	17031	1791		1	
63	5		1792		1	

- with fuse base DII for 16A DIII for 32A and 63A



16	4	17034	1787	17334	1	
16	5		1788		1	
32	4	17035	1789	17238	1	
32	5		1790		1	
63	4	17036	1771	1773	1	3720
63	5		1770		1	

- with 3-pole C-type MCB



16	4	17289	17290		1	
16	5		17291		1	2000
32	4	17292	17293		1	
32	5		17294		1	
63	4	17295	17296		1	
63	5		17297		1	3715

- with C-type MCB and RCCB 40/0,03A for 16A and 32A



16	4	17307	17308		1	
16	5		17309		1	
32	4	17310	17311		1	

- with D02 and RCCB 63/0,03A for 63A



32	5		17312		1	3965
63	4	17313	17314		1	
63	5		17315		1	

- with load-break switch NH00



63	4	17038	1795	17336	1	
63	5		1796		1	

Sockets

Surface Mounting Socket Outlets, switched, interlocked and fused

Technical Information

- IEC 60309-1/2, EN 60309, VDE 0623
- Enclosure, window and socket insert made of high-grade plastic

Surface Mounting Socket Outlet

- Switched, Interlocked
- Lockable in 0-position
- With Din rail
- 6 modules for 16A and 32A, 8 modules for 63A
- 63A with box terminals and Kontex contact
- Nickel plated contacts
- Protection degree IP44
- Products with PILOT please add "P" to the ref.no.



17524

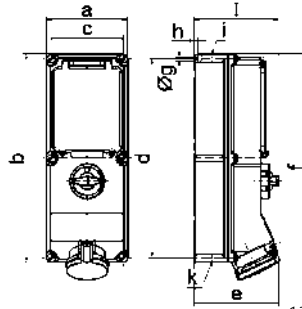

Ampere Poles	16 4	16 5	32 4	32 5	63 4	63 5
a	134,0	134,0	134,0	134,0	180,0	180,0
b	365,0	365,0	365,0	365,0	460,0	460,0
c	117,0	117,0	117,0	117,0	160,0	160,0
d	348,0	348,0	348,0	348,0	440,0	440,0
e	135,0	141,0	146,0	152,0	184,0	184,0
f	382,0	382,0	391,0	391,0	500,0	500,0
ø g	6,5	6,5	6,5	6,5	8,3	8,3
h	8,0	8,0	8,0	8,0	6,5	6,5
i	M25/32	M25/32	M32/40	M32/40	M40	M40
k	M25/32	M25/32	M32/40	M32/40	M32/40	M32/40
l	156,0	156,0	156,0	156,0	189,0	189,0

Protection

			110V 50-60 Hz	230V 50-60 Hz	400V 50-60 Hz	500V 50-60 Hz	>50V 100-300Hz	>50V 301-500Hz		g
2P+E	3P+E	3+N+E	3pol 4pol 5pol 4h 4h 4h	3pol 4pol 5pol 6h 9h 9h	3pol 4pol 5pol 9h 6h 6h	3pol 4pol 5pol 7h 7h 7h	3pol 4pol 5pol 10h 10h 10h	3pol 4pol 5pol 2h 2h 2h	Quantity	Each

- without fuse protection

16	3	17087							1	
16	4	17165	17164	17166					1	1650
16	5		17163						1	
32	3	17107								
32	4	17167	17168	17169					1	1855
32	5		17170						1	1960
63	3	17134								
63	4	17521	17522	17523					1	3205
63	5		17524						1	3450

- with fuse base
D01 for 16A
D02 for 32A and 63A



16	4	17039	1797						1	
16	5		1798						1	
32	4	17040	1799						1	
32	5		17000						1	
63	4	17525	17526						1	
63	5		17527						1	3720

- with fuse base
DII for 16A
DIII for 32A and 63A



16	4	17044	17007	17019					1	2005
16	5		17008						1	
32	4	17045	17009	17020					1	2390
32	5		17010						1	
63	4	17528	17529	17530					1	3740
63	5		17531						1	

- with 3-pole C-type MCB



16	4	17316	17186						1	
16	5		17187						1	
32	4	17317	17188						1	
32	5		17189						1	
63	4	17532	17533						1	
63	5		17534						1	

- with C-type MCB and RCCB
40/0,03A for 16A and 32A



16	4	17322	17323						1	
16	5		17343						1	2430
32	4	17324	17325						1	

- with D02 and RCCB 63/0,03A
for 63A



32	5		17344						1	2650
63	4	17535	17536						1	
63	5		17537						1	

- with load-break switch NH00



63	4	17555	17556	17557					1	3705
63	5		17558						1	

Surface Mounting Socket Outlets, switched, interlocked, fused

Technical Information

- IEC 60309-1/2, EN 60309, VDE 0623
- Enclosure, window and socket insert made of high-grade plastic

Surface Mounting Socket Outlet

- Switched, Interlocked
- Lockable in 0-position
- With Din rail
- 6 modules for 16A and 32A, 8 modules for 63A
- 63A with box terminals and Kontex contact
- Nickel plated contacts
- Protection degree IP67
- Products with PILOT please add "P" to the ref.no.

17541

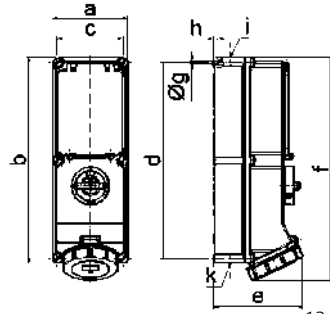

Ampere Poles	16 4	16 5	32 4	32 5	63 4	63 5
a	134,0	134,0	134,0	134,0	180,0	180,0
b	365,0	365,0	365,0	365,0	460,0	460,0
c	117,0	117,0	117,0	117,0	160,0	160,0
d	348,0	348,0	348,0	348,0	440,0	440,0
e	136,0	143,0	152,0	158,0	191,0	191,0
f	389,0	389,0	399,0	399,0	500,0	500,0
ø g	6,5	6,5	6,5	6,5	8,3	8,3
h	8,0	8,0	8,0	8,0	6,5	6,5
i	M25/32	M25/32	M32/40	M32/40	M40	M40
k	M25/32	M25/32	M32/40	M32/40	M32/40	M32/40

12 MB 12

Protection



110V 50-60 Hz

230V 50-60 Hz

400V 50-60 Hz

500V 50-60 Hz

>50V 100-300Hz

>50V 301-500Hz



Quantity Each

- without fuse protection

Ampere	Poles	110V 50-60 Hz	230V 50-60 Hz	400V 50-60 Hz	500V 50-60 Hz	>50V 100-300Hz	>50V 301-500Hz	Quantity	Each
16	3		17387						
16	4		17175	17176	17177			1	1685
16	5			17178				1	1735
32	3		17213						
32	4		17179	17180	17181			1	1900
32	5			17182				1	2033
63	3		17216						
63	4		17538	17539	17540			1	3260
63	5			17541				1	3415

- with fuse base D01 for 16A D02 for 32A and 63A



16	4		17041	17001				1	
16	5			17002				1	
32	4		17042	17003				1	
32	5			17004				1	
63	4		17542	17543				1	
63	5			17544				1	

- with fuse base DII for 16A DIII for 32A and 63A



16	4		17046	17011	17021			1	
16	5			17012				1	
32	4		17047	17013	17022			1	
32	5			17014				1	
63	4		17545	17546	17547			1	3790
63	5			17548				1	

- with 3-pole C-type MCB



16	4		17319	17192				1	
16	5			17193				1	
32	4		17320	17194				1	
32	5			17195				1	2305
63	4		17549	17550				1	
63	5			17551				1	

- with C-type MCB and RCCB 40/0,03A for 16A and 32A



16	4		17328	17329				1	
16	5			17345				1	2450
32	4		17330	17331				1	

- with D02 and RCCB 63/0,03A for 63A



32	5			17346				1	
63	4		17552	17553				1	
63	5			17554				1	4240

- with load-break switch NH00



63	4		17559	17560	17561			1	
63	5			17562				1	3880

Sockets

Surface Mounting Socket Outlets, switched, interlocked

Technical Information

- IEC 60309, EN 60309, VDE 0623
- Particularly suitable for harsh operating conditions, especially resistant to aggressive atmospheres

Surface Mounting Socket Outlet

- Switched
- With mechanical double interlocking
- Lockable in 0-position
- High-temperature-resistant contact carrier
- Nickel plated contacts
- Protection degree IP44

Dimension drawing: see page 53/1 (12 MB 3)

16907



2P+E Ampere	3P+E Poles	230V 50-60 Hz			400V 50-60 Hz			500V 50-60 Hz			Quantity	g
		3pol 6h	4pol 9h	5pol 9h	3pol 9h	4pol 6h	5pol 6h	3pol 7h	4pol 7h	5pol 7h		
16	5	16906			16907						1	655

Surface Mounting Socket Outlet

- Switched
- With mechanical double interlocking
- Lockable in 0-position
- High-temperature-resistant contact carrier
- Nickel plated contacts
- Protection degree IP44

Dimension drawing: see page 53/2 (12 MB 24)



2P+E Ampere	3P+E Poles	230V 50-60 Hz			400V 50-60 Hz			500V 50-60 Hz			Quantity	g
		3pol 6h	4pol 9h	5pol 9h	3pol 9h	4pol 6h	5pol 6h	3pol 7h	4pol 7h	5pol 7h		
16	5				160180						1	1010

Surface Mounting Socket Outlet

- Switched
- With mechanical double interlocking
- Lockable in 0-position
- High-temperature-resistant contact carrier
- Nickel plated contacts
- Protection degree IP44

Dimension drawing: see page 53/2 (12 MB 24)



2P+E Ampere	3P+E Poles	230V 50-60 Hz			400V 50-60 Hz			500V 50-60 Hz			Quantity	g
		3pol 6h	4pol 9h	5pol 9h	3pol 9h	4pol 6h	5pol 6h	3pol 7h	4pol 7h	5pol 7h		
32	5				160181						1	1295

Surface Mounting Socket Outlet

- Switched
- With mechanical double interlocking
- Lockable in 0-position
- High-temperature-resistant contact carrier
- Kontex contact and box terminals
- Nickel plated contacts
- Protection degree IP44
- Products with PILOT please add "P" to the ref.no.

Dimension drawing: see page 53/3 (12 MB 30)



2P+E Ampere	3P+E Poles	230V 50-60 Hz			400V 50-60 Hz			500V 50-60 Hz			Quantity	g
		3pol 6h	4pol 9h	5pol 9h	3pol 9h	4pol 6h	5pol 6h	3pol 7h	4pol 7h	5pol 7h		
63	5				16901						1	2245

Technical Information

- IEC 60309, EN 60309, VDE 0623
- Particularly suitable for harsh operating conditions, especially resistant to aggressive atmospheres

Surface Mounting Socket Outlet

- Switched
- With mechanical double interlocking
- Lockable in 0-position
- High-temperature-resistant contact carrier
- Nickel plated contacts
- Protection degree IP67

Dimension drawing: see page 54/1 (12 MB 6)

16916



Ampere	Poles	230V 50-60 Hz			400V 50-60 Hz			500V 50-60 Hz			Quantity	Each
		3pol	4pol	5pol	3pol	4pol	5pol	3pol	4pol	5pol		
16	5	6h	9h	9h	9h	6h	6h	7h	7h	7h	1	690

Surface Mounting Socket Outlet

- Switched
- With mechanical double interlocking
- Lockable in 0-position
- High-temperature-resistant contact carrier
- Nickel plated contacts
- Protection degree IP67

Dimension drawing: see page 54/2 (12 MB 11)



Ampere	Poles	230V 50-60 Hz			400V 50-60 Hz			500V 50-60 Hz			Quantity	Each
		3pol	4pol	5pol	3pol	4pol	5pol	3pol	4pol	5pol		
16	5	6h	9h	9h	9h	6h	6h	7h	7h	7h	1	1095

Surface Mounting Socket Outlet

- Switched
- With mechanical double interlocking
- Lockable in 0-position
- High-temperature-resistant contact carrier
- Nickel plated contacts
- Protection degree IP67

Dimension drawing: see page 54/2 (12 MB 11)



Ampere	Poles	230V 50-60 Hz			400V 50-60 Hz			500V 50-60 Hz			Quantity	Each
		3pol	4pol	5pol	3pol	4pol	5pol	3pol	4pol	5pol		
32	5	6h	9h	9h	9h	6h	6h	7h	7h	7h	1	1400

Surface Mounting Socket Outlet

- Switched
- With mechanical double interlocking
- Lockable in 0-position
- High-temperature-resistant contact carrier
- Kontex contact and box terminals
- Nickel plated contacts
- Protection degree IP67

Dimension drawing: see page 54/3 (12 MB 10)



Ampere	Poles	230V 50-60 Hz			400V 50-60 Hz			500V 50-60 Hz			Quantity	Each
		3pol	4pol	5pol	3pol	4pol	5pol	3pol	4pol	5pol		
63	5	6h	9h	9h	9h	6h	6h	7h	7h	7h	1	2315

Surface Mounting Socket Outlet

- Switched
- With mechanical double interlocking
- Lockable in 0-position
- High-temperature-resistant contact carrier
- Kontex contact and box terminals
- Nickel plated contacts
- Protection degree IP67
- Products with PILOT please add "P" to the ref.no.

Dimension drawing: see page 55/1 (12 MB 5)



Ampere	Poles	230V 50-60 Hz			400V 50-60 Hz			500V 50-60 Hz			Quantity	Each
		3pol	4pol	5pol	3pol	4pol	5pol	3pol	4pol	5pol		
125	5	6h	9h	9h	9h	6h	6h	7h	7h	7h	1	4065

1

2

3

4

5

6

7

Sockets

Surface Mounting Socket Outlets, switched, interlocked, fused

Technical Information

- IEC 60309, EN 60309, VDE 0623
- Particularly suitable for harsh operating conditions, especially resistant to aggressive atmospheres

Surface Mounting Socket Outlet

- Switched, interlocked
- Lockable in 0-position
- With Din rail
- 6 DU for 16A and 32A, 8 DU for 63A
- High-temperature-resistant contact carrier
- Nickel plated contacts
- 63A Box terminals
- Protection degree IP44
- Products with PILOT add "P" to the ref. no.



17566

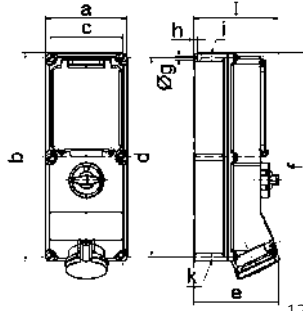

Ampere Poles	16 5	32 5	63 5
a	134,0	134,0	180,0
b	365,0	365,0	460,0
c	117,0	117,0	160,0
d	348,0	348,0	440,0
e	141,0	152,0	184,0
f	382,0	391,0	500,0
ø g	6,5	6,5	8,3
h	8,0	8,0	6,5
i	M25/32	M32/40	M40
k	M25/32	M32/40	M32/40
l	156,0	156,0	189,0

Protection

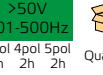
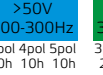
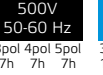
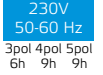
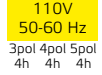

	16	5		Quantity	Each
			17608	1	
- without fuse protection	32	5	17612	1	
	63	5	17566	1	
- with fuse base D01 for 16A D02 for 32A and 63A	16	5	17615	1	
	32	5	17618	1	
	63	5	17569	1	3880
- with fuse base DII for 16A DIII for 32A and 63A	16	5	17622	1	
	32	5	17626	1	
	63	5	17573	1	
- with 3-pole C-type MCB	16	5	17629	1	
	32	5	17632	1	
	63	5	17576	1	
- with C-type MCB and RCCB 40/0,03A for 16A and 32A	16	5	17635	1	
	32	5	17638	1	
- with D02 and RCCB 63/0,03A for 63A	63	5	17579	1	

Technical Information

- IEC 60309, EN 60309, VDE 0623
- Particularly suitable for harsh operating conditions, especially resistant to aggressive atmospheres

Surface Mounting Socket Outlet

- Switched, interlocked
- Lockable in 0-position
- With Din rail
- 6 DU f. 16A and 32A, 8 DU f. 63A
- High-temperature-resistant contact carrier
- Nickel plated contacts
- 63A Box terminals
- Protection degree IP67
- Products with PILOT add "P" to the ref. no.



17583

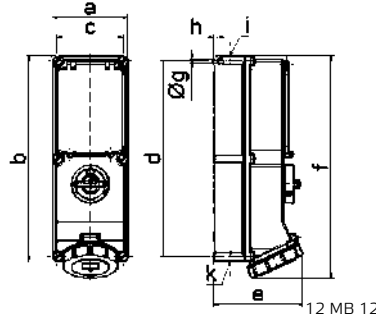

Ampere Poles	16 5	32 5	63 5
a	134,0	134,0	180,0
b	365,0	365,0	460,0
c	117,0	117,0	160,0
d	348,0	348,0	440,0
e	143,0	158,0	191,0
f	389,0	399,0	500,0
ø g	6,5	6,5	8,3
h	8,0	8,0	6,5
i	M25/32	M32/40	M40
k	M25/32	M32/40	M32/40

Protection

							>50V 100-300Hz symbol"/>	>50V 301-500Hz symbol"/>		9
Ampere	Poles		3pol 4pol 5pol 4h 4h 4h	3pol 4pol 5pol 6h 9h 9h	3pol 4pol 5pol 9h 6h 6h	3pol 4pol 5pol 7h 7h 7h	3pol 4pol 5pol 10h 10h 10h	3pol 4pol 5pol 2h 2h 2h	Quantity	Each

- without fuse protection

16	5	17642	1
32	5	17646	1 2060
63	5	17583	1 3535

- with fuse base
D01 for 16A
D02 for 32A and 63A



16	5	17649	1
32	5	17652	1
63	5	17586	1

- with fuse base
DII for 16A
DIII for 32A and 63A



16	5	17656	1
32	5	17660	1
63	5	17590	1 3985

- with 3-pole C-type MCB



16	5	17663	1
32	5	17666	1
63	5	17593	1

- with C-type MCB and RCCB
40/0,03A for 16A and 32A



16	5	17669	1
32	5	17672	1

- with D02 and RCCB 63/0,03A
for 63A



63	5	17596	1
----	---	--------------	---

- with load-break switch NH00



63	5	17604	1 4025
----	---	--------------	--------

Panel Mounting Socket Outlet QUICK-CONNECT

- Screwless terminals
- Kontex contact
- Flange 75 x 75 mm
- Protection degree IP44

QUICK CONNECT



132002

Ampere	Poles	110V 50-60 Hz	230V 50-60 Hz	400V 50-60 Hz	500V 50-60 Hz	>50V 100-300Hz	>50V 301-500Hz	Quantity	Each
		3pol 4pol 5pol 4h 4h 4h	3pol 4pol 5pol 6h 9h 9h	3pol 4pol 5pol 9h 6h 6h	3pol 4pol 5pol 7h 7h 7h	3pol 4pol 5pol 10h 10h 10h	3pol 4pol 5pol 2h 2h 2h		
16	3	13685	13686	13687	13688	13689	13690	10	105
16	4	13691	13692	13693	13694	13695	13696	10	120
16	5	13697	13698	132001	13699	13700	13701	10	135
32	3	13702	13703	13704	13705	13706	13707	10	165
32	4	13708	13709	13710	13711	13712	13713	10	185
32	5	13714	13715	132002	13716	13717	13718	10	220

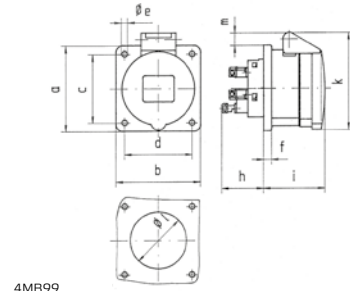

4MB99

Ampere Poles	16 3	16 4	16 5	32 3	32 4	32 5
a	75,0	75,0	75,0	75,0	75,0	75,0
b	75,0	75,0	75,0	75,0	75,0	75,0
c	60,0	60,0	60,0	60,0	60,0	60,0
d	60,0	60,0	60,0	60,0	60,0	60,0
ø e	5,5	5,5	5,5	5,5	5,5	5,5
f	7,0	7,0	7,0	8,0	8,0	8,0
h	35,5	35,5	35,5	50,0	50,0	50,0
i	50,0	50,0	51,0	60,0	60,0	60,0
k	74,0	84,0	91,0	94,0	94,0	102,0
ø l	45,0	45,0	55,0	60,0	60,0	60,0
m	3,5	7,0	11,5	12,0	12,0	17,0
Cond. mm² min	1,5	1,5	1,5	2,5	2,5	2,5
Cond. mm² max	4	4	4	10	10	10

Panel Mounting Socket Outlet QUICK-CONNECT

- Screwless terminals
- Kontex contact
- Flange 75 x 75 mm
- Protection degree IP44

QUICK CONNECT



13850

Ampere	Poles	110V 50-60 Hz	230V 50-60 Hz	400V 50-60 Hz	500V 50-60 Hz	>50V 100-300Hz	>50V 301-500Hz	Quantity	Each	
		3pol 4pol 5pol 4h 4h 4h	3pol 4pol 5pol 6h 9h 9h	3pol 4pol 5pol 9h 6h 6h	3pol 4pol 5pol 7h 7h 7h	3pol 4pol 5pol 10h 10h 10h	3pol 4pol 5pol 2h 2h 2h			
16	3	13851							10	105
16	4									
16	5								10	135
32	3									
32	4									
32	5								10	220

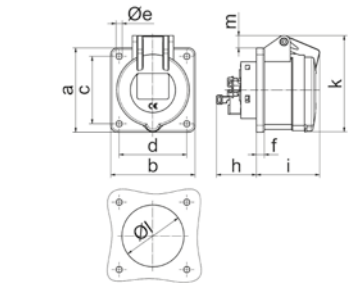

4MB103

Ampere Polzahl	16 3	16 4	16 5	32 3	32 4	32 5
a	75,0	75,0	75,0	75,0	75,0	75,0
b	75,0	75,0	75,0	75,0	75,0	75,0
c	60,0	60,0	60,0	60,0	60,0	60,0
d	60,0	60,0	60,0	60,0	60,0	60,0
ø e	5,5	5,5	5,5	5,5	5,5	5,5
f	7,0	7,0	7,0	8,0	8,0	8,0
h	35,5	35,5	35,5	50,0	50,0	50,0
i	52,0	53,0	57,0	65,0	65,0	66,0
ø l	45,0	45,0	55,0	60,0	60,0	60,0
m	3,5	7,0	11,5	12,0	12,0	17,0
x	71,5	80,0	86,0	91,0	91,0	99,0
y	75,0	75,0	75,0	75,0	75,0	75,0
z	88,0	89,0	93,0	115,0	115,0	116,0
Cond. mm² min	1,5	1,5	1,5	2,5	2,5	2,5
Cond. mm² max	4,0	4,0	4,0	10,0	10,0	10,0

Panel Mounting Socket Outlet QUICK-CONNECT

- Screwless terminals
- Kontex contact
- Flange 56 x 56 mm for 16A 3p, 60 x 60 mm for 16A 4p
- Protection degree IP44

QUICK CONNECT



13663

Ampere	Poles	110V 50-60 Hz	230V 50-60 Hz	400V 50-60 Hz	500V 50-60 Hz	>50V 100-300Hz	>50V 301-500Hz	Quantity	Each
		3pol 4pol 5pol 4h 4h 4h	3pol 4pol 5pol 6h 9h 9h	3pol 4pol 5pol 9h 6h 6h	3pol 4pol 5pol 7h 7h 7h	3pol 4pol 5pol 10h 10h 10h	3pol 4pol 5pol 2h 2h 2h		
16	3	13656	13646	13657	13658	13659	13660	10	90
16	4	13661	13662	13663	13664	13665	13666	10	110

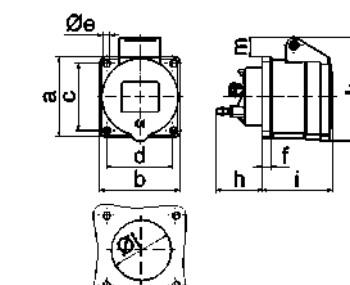

4 MB 101

Ampere Poles	16 3	16 4
a	56,0	60,0
b	56,0	60,0
c	44,0	50-52
d	44,0	50-52
ø e	5,5	5,5
f	7,0	7,0
h	35,5	35,5
i	51,0	53,0
k	70,0	80,0
ø l	45,0	45,0
m	13,0	9,0
Cond. mm² min	1,5	1,5
Cond. mm² max	4	4

Technical Information

- IEC 60309-1/2, EN 60309, VDE 0623

Panel Mounting Socket Outlet QUICK-CONNECT

- Screwless terminals
- Kontex contact
- Flange 62 x 62 mm for 16A 3p, 72 x 65 mm for 16A 4p and 5p
- Protection degree IP44

QUICK CONNECT



13681

Amperage	Poles	110V 50-60 Hz	230V 50-60 Hz	400V 50-60 Hz	500V 50-60 Hz	>50V 100-300Hz	>50V 301-500Hz	Quantity	Each
		3pol 4pol 5pol 4h 4h 4h	3pol 4pol 5pol 6h 9h 9h	3pol 4pol 5pol 9h 6h 6h	3pol 4pol 5pol 7h 7h 7h	3pol 4pol 5pol 10h 10h 10h	3pol 4pol 5pol 2h 2h 2h		
16	3	13667	13668	13669	13670	13671	13672	10	95
16	4	13673	13674	13675	13676	13677	13678	10	120
16	5	13679	13680	13681	13682	13683	13684	10	130

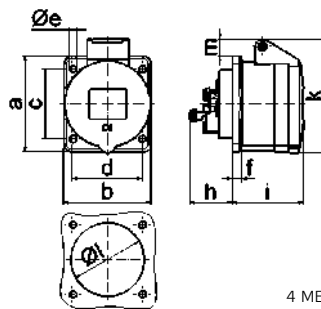

Amperage	Poles	16	16	16
a	3	62,0	72,0	72,0
b	4	62,0	65,0	65,0
c	5	47,0	52,0	52,0
d		47,0	52,0	52,0
ø e		5,5	5,5	5,5
f		7,0	7,0	7,0
h		35,5	35,5	35,5
i		51,0	53,0	53,0
k		70,0	80,0	85,0
ø l		45,0	45,0	55,0
m		13,0	9,0	13,0
Cond. mm² min		1,5	1,5	1,5
Cond. mm² max		4	4	4

4 MB 100

Panel Mounting Socket Outlet QUICK-CONNECT

- Screwless terminals
- Kontex contact
- Flange 70 x 70 mm
- Protection degree IP44

QUICK CONNECT



13895

Amperage	Poles	110V 50-60 Hz	230V 50-60 Hz	400V 50-60 Hz	500V 50-60 Hz	>50V 100-300Hz	>50V 301-500Hz	Quantity	Each
		3pol 4pol 5pol 4h 4h 4h	3pol 4pol 5pol 6h 9h 9h	3pol 4pol 5pol 9h 6h 6h	3pol 4pol 5pol 7h 7h 7h	3pol 4pol 5pol 10h 10h 10h	3pol 4pol 5pol 2h 2h 2h		
16	5			13895				10	120
32	5			13896				10	220

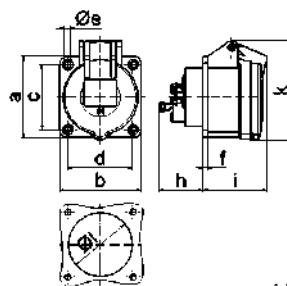

Amperage	Poles	16	32
a	5	70,0	70,0
b		70,0	70,0
c		56,0	56,0
d		56,0	56,0
ø e		5,5	5,5
f		4,0	4,0
h		35,5	46,0
i		57,0	66,0
k		86,0	99,0
ø l		55,0	60,0
Cond. mm² min		1,5	2,5
Cond. mm² max		4	10

4 MB 166

Panel Mounting Socket Outlet

- Screw terminals
- Flange 107 x 100 mm
- Kontex contact
- Nickel plated contacts
- Box terminals
- Protection degree IP44
- Products with PILOT please add "P" to the ref.no.

136

Amperage	Poles	110V 50-60 Hz	230V 50-60 Hz	400V 50-60 Hz	500V 50-60 Hz	>50V 100-300Hz	>50V 301-500Hz	Quantity	Each
		3pol 4pol 5pol 4h 4h 4h	3pol 4pol 5pol 6h 9h 9h	3pol 4pol 5pol 9h 6h 6h	3pol 4pol 5pol 7h 7h 7h	3pol 4pol 5pol 10h 10h 10h	3pol 4pol 5pol 2h 2h 2h		
63	3	1306	1307	1308	13592	13254		5	415
63	4	1309	1304	134	1301	13320	13077	5	445
63	5	13140	1305	136	13168	13321	13051	5	490

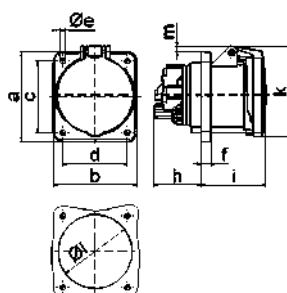

Amperage	Poles	63	63	63
a	3	107,0	107,0	107,0
b	4	100,0	100,0	100,0
c	5	85,0	85,0	85,0
d		77,0	77,0	77,0
ø e		6,5	6,5	6,5
f		12,0	12,0	12,0
h		56,5	56,5	56,5
i		77,0	77,0	77,0
k		110,0	110,0	110,0
ø l		88,0	88,0	88,0
m		7,0	7,0	7,0
Cond. mm² min		6	6	6
Cond. mm² max		25	25	25

4 MB 8

Panel Mounting Socket Outlet QUICK-CONNECT

- Screwless terminals
- Flange 107 x 100 mm
- High-temperature-resistant contact carrier
- Kontex contact
- Nickel plated contacts
- Box terminals
- Protection degree IP44

QUICK CONNECT



130114

Ampere	Poles	110V 50-60 Hz			230V 50-60 Hz			400V 50-60 Hz			500V 50-60 Hz			>50V 100-300Hz			>50V 301-500Hz			Quantity	Each
		3pol	4pol	5pol	3pol	4pol	5pol	3pol	4pol	5pol	3pol	4pol	5pol	3pol	4pol	5pol	3pol	4pol	5pol		
63	4																			5	550
63	5																			5	600

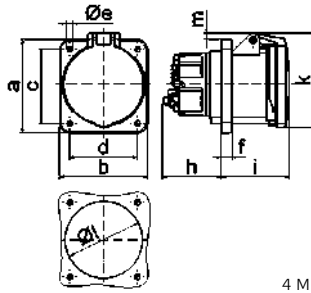

Ampere	Poles	63	63
a	107,0	107,0	
b	100,0	100,0	
c	85,0	85,0	
d	77,0	77,0	
ø e	6,5	6,5	
f	12,0	12,0	
h	67,0	67,0	
i	77,0	77,0	
k	110,0	110,0	
ø l	88,0	88,0	
m	7,0	7,0	
Cond. mm ² min		6	6
Cond. mm ² max		25	25

4 MB 265

Panel Mounting Socket Outlet QUICK-CONNECT

- Screwless terminals
- 20° angled
- Kontex contact
- Flange 68 x 62 mm for 16A 3p, 87 x 71 mm for 16A 4p and 5p
- Protection degree IP44

QUICK CONNECT



12741

Ampere	Poles	110V 50-60 Hz			230V 50-60 Hz			400V 50-60 Hz			500V 50-60 Hz			>50V 100-300Hz			>50V 301-500Hz			Quantity	Each
		3pol	4pol	5pol	3pol	4pol	5pol	3pol	4pol	5pol	3pol	4pol	5pol	3pol	4pol	5pol					
16	3																			10	95
16	4																			10	120
16	5																			10	140

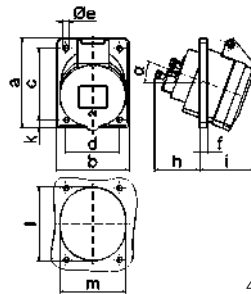

Ampere	Poles	16	16	16
a	68,0	87,0	87,0	
b	62,0	71,0	71,0	
c	47,0	70,0	70,0	
d	47,0	52,0	52,0	
ø e	5,5	5,5	5,5	
f	8,0	5,5	5,5	
h	46,0	46,0	46,0	
i	50,0	54,0	54,0	
k	-	9,5	9,5	
l	56,0	65,0	72,0	
m	51,0	58,0	64,0	
α	20°	20°	20°	
Cond. mm ² min		1,5	1,5	1,5
Cond. mm ² max		4	4	4

4 MB 111

Panel Mounting Socket Outlet QUICK-CONNECT

- Screwless terminals
- 20° angled
- Kontex contact
- Flange 75 x 75 mm
- Protection degree IP44

QUICK CONNECT



122001

Ampere	Poles	110V 50-60 Hz			230V 50-60 Hz			400V 50-60 Hz			500V 50-60 Hz			>50V 100-300Hz			>50V 301-500Hz			Quantity	Each
		3pol	4pol	5pol	3pol	4pol	5pol	3pol	4pol	5pol	3pol	4pol	5pol	3pol	4pol	5pol					
16	5																			10	135

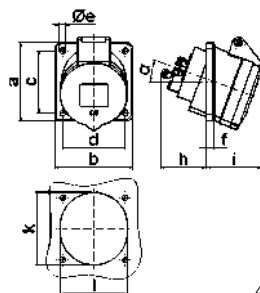

Ampere	Poles	16
a	75,0	75,0
b	75,0	75,0
c	60,0	60,0
d	60,0	60,0
ø e	5,5	5,5
f	8,0	8,0
h	46,0	46,0
i	54,0	54,0
k	70,0	70,0
l	65,0	65,0
α	20°	20°
Cond. mm ² min		1,5
Cond. mm ² max		4

4 MB 110

Panel Mounting Socket Outlet QUICK-CONNECT

- Screwless terminals
- 20° angled
- Kontex contact
- Flange 85 x 85 mm
- Protection degree IP44

QUICK CONNECT



12757

Ampere	Poles	110V 50-60 Hz	230V 50-60 Hz	400V 50-60 Hz	500V 50-60 Hz	>50V 100-300Hz	>50V 301-500Hz	Quantity	Each
		3pol 4pol 5pol 4h 4h 4h	3pol 4pol 5pol 6h 9h 9h	3pol 4pol 5pol 9h 6h 6h	3pol 4pol 5pol 7h 7h 7h	3pol 4pol 5pol 10h 10h 10h	3pol 4pol 5pol 2h 2h 2h		
16	3	12748	12749	12750	12751	12861	12752	10	120
16	4	12862	12863	12753	12864	12754	12865	10	135
16	5	12755	12756	12757	12758	12866	12759	10	145
32	3	12760	12761	12867	12762	12868	12869	10	180
32	4	12870	12763	12764	12765	12871	12872	10	200
32	5	12766	12767	12768	12769	12770	12873	10	235

Ampere	Poles	16	16	16	32	32	32
a	85,0	85,0	85,0	85,0	85,0	85,0	85,0
b	85,0	85,0	85,0	85,0	85,0	85,0	85,0
c	70,0	70,0	70,0	70,0	70,0	70,0	70,0
d	70,0	70,0	70,0	70,0	70,0	70,0	70,0
ø e	5,5	5,5	5,5	5,5	5,5	5,5	5,5
f	8,0	8,0	8,0	8,0	8,0	8,0	8,0
h	46,0	46,0	46,0	55,0	55,0	55,0	55,0
i	50,0	51,0	54,0	60,0	60,0	60,0	60,0
ø l	57,0	65,0	70,0	78,0	78,0	78,0	78,0
α	20°	20°	20°	20°	20°	20°	20°
Cond. mm² min	1,5	1,5	1,5	2,5	2,5	2,5	2,5
Cond. mm² max	4	4	4	10	10	10	10

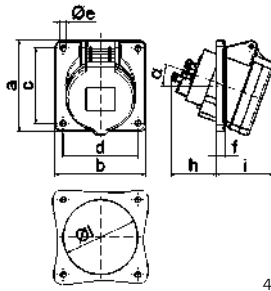

4 MB 264

Panel Mounting Socket Outlet QUICK-CONNECT

- Screwless terminals
- 20° angled
- Kontex contact
- Flange 74 x 62 mm for 16A 3p,
100 x 92 mm for the other versions
- Protection degree IP44



12730

Ampere	Poles	110V 50-60 Hz	230V 50-60 Hz	400V 50-60 Hz	500V 50-60 Hz	>50V 100-300Hz	>50V 301-500Hz	Quantity	Each
		3pol 4pol 5pol 4h 4h 4h	3pol 4pol 5pol 6h 9h 9h	3pol 4pol 5pol 9h 6h 6h	3pol 4pol 5pol 7h 7h 7h	3pol 4pol 5pol 10h 10h 10h	3pol 4pol 5pol 2h 2h 2h		
16	3	12771	12772	12773	12774	12775	12776	10	100
16	4	12777	12778	12779	12780	12781	12782	10	140
16	5	12783	12784	12730	12785	12786	12787	10	160
32	3	12788	12789	12790	12874	12791	12792	10	200
32	4	12793	12794	12795	12796	12797	12798	10	210
32	5	12799	12800	12801	12802	12803	12804	10	240

Ampere	Poles	16	16	16	32	32	32
a	74,0	100,0	100,0	100,0	100,0	100,0	100,0
b	62,0	92,0	92,0	92,0	92,0	92,0	92,0
c	60,0	85,0	85,0	85,0	85,0	85,0	85,0
d	52,0	77,0	77,0	77,0	77,0	77,0	77,0
ø e	5,5	5,5	5,5	5,5	5,5	5,5	5,5
f	8,0	8,0	8,0	8,0	8,0	8,0	8,0
h	46,0	46,0	46,0	55,0	55,0	55,0	55,0
i	48,0	50,0	55,0	68,0	68,0	68,0	68,0
k	57,0	65,0	70,0	75,0	75,0	78,0	78,0
l	52,0	65,0	70,0	75,0	75,0	78,0	78,0
α	20°	20°	20°	20°	20°	20°	20°
Cond. mm² min	1,5	1,5	1,5	2,5	2,5	2,5	2,5
Cond. mm² max	4	4	4	10	10	10	10

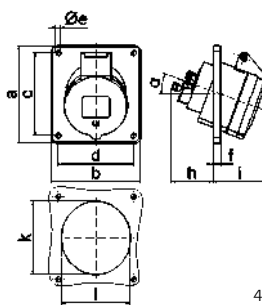

4 MB 112

Panel Mounting Socket Outlet QUICK-CONNECT

- Screwless terminals
- 20° angled
- Kontex contact
- Flange 110 x 110 mm
- Protection degree IP44



12805

Ampere	Poles	110V 50-60 Hz	230V 50-60 Hz	400V 50-60 Hz	500V 50-60 Hz	>50V 100-300Hz	>50V 301-500Hz	Quantity	Each
		3pol 4pol 5pol 4h 4h 4h	3pol 4pol 5pol 6h 9h 9h	3pol 4pol 5pol 9h 6h 6h	3pol 4pol 5pol 7h 7h 7h	3pol 4pol 5pol 10h 10h 10h	3pol 4pol 5pol 2h 2h 2h		
16	5				12805			10	185
32	5				12806			10	260

Ampere	Poles	16	32
a	110,0	110,0	
b	110,0	110,0	
c	90,0	90,0	
d	90,0	90,0	
ø e	5,5	5,5	
f	8,0	8,0	
h	46,0	55,0	
i	56,0	60,0	
ø l	75,0	78,0	
Cond. mm² min	1,5	2,5	
Cond. mm² max	4	10	

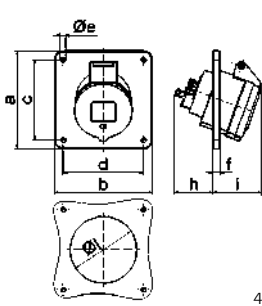

4 MB 269

Panel Mounting Socket Outlet

- Screw terminals
- 15° angled
- Flange 100 x 92 mm
- Kontex contact
- Box terminals
- Nickel plated contacts
- Protection degree IP44
- Products with PILOT please add "P" to the ref.no.



12567

Ampere	Poles	110V	230V	400V	500V	>50V	>50V	Quantity	Each
		50-60 Hz	50-60 Hz	50-60 Hz	50-60 Hz	100-300Hz	301-500Hz		
63	3		12563					10	415
63	4			12074	12565			10	430
63	5	12566	12568	12567				10	475

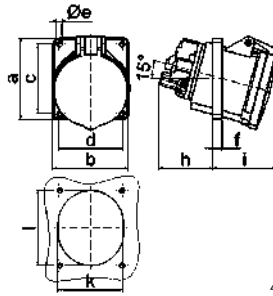

4 MB 64

Ampere	Poles	63	63	63
	3	100,0	100,0	100,0
	4	92,0	92,0	92,0
	5	85,0	85,0	85,0
		77,0	77,0	77,0
		6,5	6,5	6,5
		12,0	12,0	12,0
		65,0	65,0	65,0
		81,0	81,0	81,0
		80,0	80,0	80,0
		92,0	92,0	92,0
Cond. mm² min		6	6	6
Cond. mm² max		25	25	25

Panel Mounting Socket Outlet

- Screw terminals
- 15° angled
- Flange 114 x 114 mm
- Kontex contact
- Box terminals
- Nickel plated contacts
- Protection degree IP44
- Products with PILOT please add "P" to the ref.no.



1202

Ampere	Poles	110V	230V	400V	500V	>50V	>50V	Quantity	Each
		50-60 Hz	50-60 Hz	50-60 Hz	50-60 Hz	100-300Hz	301-500Hz		
63	3	12134	12135	12136		12381	12230	5	420
63	4	12137	1207	1201	1204	12382	12153	5	460
63	5	12138	1208	1202	12195	12383		5	500

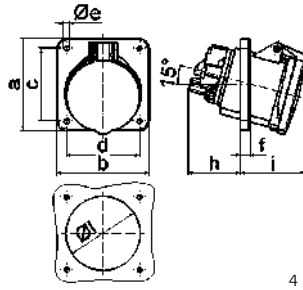

4 MB 10

Ampere	Poles	63	63	63
	3	114,0	114,0	114,0
	4	114,0	114,0	114,0
	5	90,0	90,0	90,0
		90,0	90,0	90,0
		6,5	6,5	6,5
		12,0	12,0	12,0
		65,0	65,0	65,0
		81,0	81,0	81,0
		92,0	92,0	92,0
Cond. mm² min		6	6	6
Cond. mm² max		25	25	25

Panel Mounting Socket Outlet QUICK-CONNECT

- Screwless terminals
- 15° angled
- Flange 114 x 114 mm
- High-temperature-resistant contact carrier
- Kontex contact
- Nickel plated contacts
- Box terminals
- Protection degree IP44



120306

Ampere	Poles	110V	230V	400V	500V	>50V	>50V	Quantity	Each
		50-60 Hz	50-60 Hz	50-60 Hz	50-60 Hz	100-300Hz	301-500Hz		
63	4			120321	120431			5	570
63	5			120306				5	620

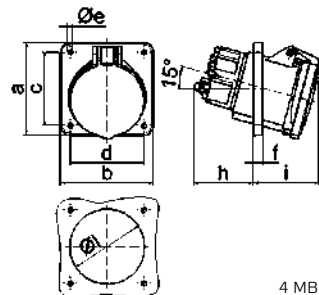

4 MB 266

Ampere	Poles	63	63
	4	114,0	114,0
	5	114,0	114,0
		90,0	90,0
		90,0	90,0
		6,5	6,5
		12,0	12,0
		74,0	74,0
		81,0	81,0
		92,0	92,0
Cond. mm² min		6	6
Cond. mm² max		25	25

Technical Information

- IEC 60309-1/2, EN 60309, VDE 0623

Panel Mounting Socket Outlet QUICK-CONNECT

- Screwless terminals
- Kontex contact
- Flange 62 x 62 mm for 16A 3p, 72 x 65 mm for 16A 4p and 5p
- Protection degree IP67

QUICK CONNECT



13732

Amperage	Poles	110V	230V	400V	500V	>50V	>50V	Quantity	Each
		50-60 Hz	50-60 Hz	50-60 Hz	50-60 Hz	100-300Hz	301-500Hz		
16	3	13719	13720	13721				10	120
16	4	13724	13725	13726	13727			10	150
16	5	13730	13731	13732				10	170

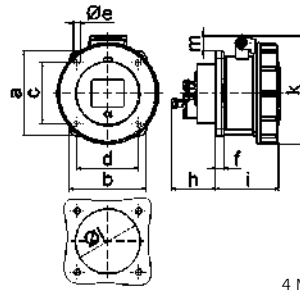

Amperage	Poles	16	16	16
a	3	62,0	72,0	72,0
b	4	62,0	65,0	65,0
c	5	47,0	52,0	52,0
d		47,0	52,0	52,0
ø e		5,5	5,5	5,5
f		7,0	7,0	7,0
h		35,5	35,5	35,5
i		57,0	58,0	57,0
k		76,0	83,0	93,0
ø l		45,0	45,0	55,0
m		10,0	9,0	13,0
Cond. mm² min		1,5	1,5	1,5
Cond. mm² max		4	4	4

4 MB 104

Panel Mounting Socket Outlet QUICK-CONNECT

- Screwless terminals
- Kontex contact
- Flange 75 x 75 mm
- Protection degree IP67

QUICK CONNECT



13745

Amperage	Poles	110V	230V	400V	500V	>50V	>50V	Quantity	Each
		50-60 Hz	50-60 Hz	50-60 Hz	50-60 Hz	100-300Hz	301-500Hz		
16	3	13733	13734	13735		13736		10	130
16	4	13737	13738	13739	13740	13741	13742	10	145
16	5	13743	13744	13745	13746	13747	13748	10	160
32	3	13749	13750	13751		13752	13753	10	210
32	4	13754	13755	13756	13757	13758	13759	10	225
32	5	13760	13761	13762	13763	13764	13765	10	265

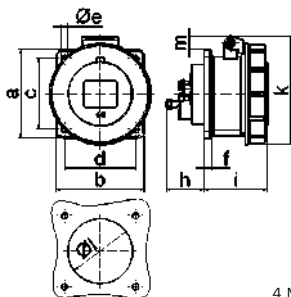

Amperage	Poles	16	16	16	32	32	32
a	3	75,0	75,0	75,0	75,0	75,0	75,0
b	4	75,0	75,0	75,0	75,0	75,0	75,0
c	5	60,0	60,0	60,0	60,0	60,0	60,0
d		60,0	60,0	60,0	60,0	60,0	60,0
ø e		5,5	5,5	5,5	5,5	5,5	5,5
f		7,0	7,0	7,0	8,0	8,0	8,0
h		35,5	35,5	35,5	46,0	46,0	46,0
i		57,0	58,0	57,0	65,0	65,0	65,0
k		76,0	83,0	93,0	100,0	100,0	106,0
ø l		45,0	45,0	55,0	60,0	60,0	60,0
m		3,5	7,0	11,5	12,0	12,0	17,0
Cond. mm² min		1,5	1,5	1,5	2,5	2,5	2,5
Cond. mm² max		4	4	4	10	10	10

4 MB 105

Panel Mounting Socket Outlet QUICK-CONNECT

- Screwless twin terminal
- Kontex contact
- Flange 75 x 75 mm
- Protection degree IP67

QUICK CONNECT



130158

Amperage	Poles	110V	230V	400V	500V	>50V	>50V	Quantity	Each
		50-60 Hz	50-60 Hz	50-60 Hz	50-60 Hz	100-300Hz	301-500Hz		
16	5							10	205

130158

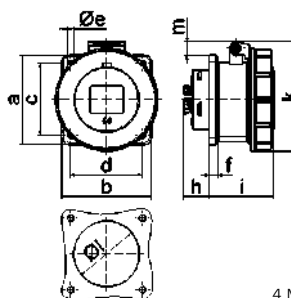

Amperage	Poles	16
a	5	75,0
b		75,0
c		60,0
d		60,0
ø e		5,5
f		7,0
h		23,0
i		57,0
k		93,0
ø l		55,0
m		11,5
Cond. mm² min		1,5
Cond. mm² max		4

4 MB 262

Panel Mounting Socket Outlet

- Screw terminals
- Flange 107 x 100 mm
- Kontex contact
- Nickel plated contacts
- Box terminals
- Protection degree IP67
- Products with PILOT please add "P" to the ref.no.



13104

Ampere	Poles	110V	230V	400V	500V	>50V	>50V	Quantity	Each
		50-60 Hz	50-60 Hz	50-60 Hz	50-60 Hz	100-300Hz	301-500Hz		
63	3	1395	1396	1397				5	460
63	4	1398	1399	13100	13101			5	490
63	5	13102	13103	13104				5	535

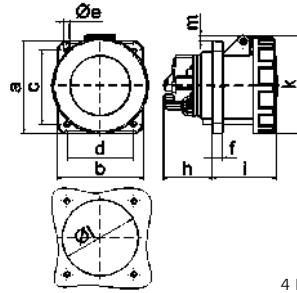

Ampere Poles	63 3	63 4	63 5
a	107,0	107,0	107,0
b	100,0	100,0	100,0
c	85,0	85,0	85,0
d	77,0	77,0	77,0
ø e	6,5	6,5	6,5
f	12,0	12,0	12,0
h	56,5	56,5	56,5
i	76,0	76,0	76,0
k	113,0	113,0	113,0
ø l	88,0	88,0	88,0
m	7,0	7,0	7,0
Cond. mm² min	6	6	6
Cond. mm² max	25	25	25

4 MB 50

Panel Mounting Socket Outlet QUICK-CONNECT

- Screwless terminals
- Flange 107 x 100 mm
- High-temperature-resistant contact carrier
- Kontex contact
- Nickel plated contacts
- Box terminals
- Protection degree IP67



130119

Ampere	Poles	110V	230V	400V	500V	>50V	>50V	Quantity	Each
		50-60 Hz	50-60 Hz	50-60 Hz	50-60 Hz	100-300Hz	301-500Hz		
63	4			130131	130154			5	565
63	5			130119				5	665

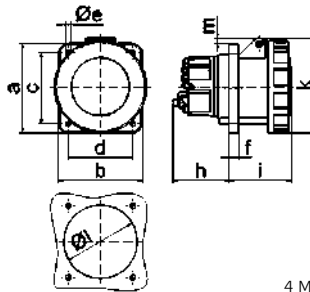

Ampere Poles	63 4	63 5
a	107,0	107,0
b	100,0	100,0
c	85,0	85,0
d	77,0	77,0
ø e	6,5	6,5
f	12,0	12,0
h	67,0	67,0
i	76,0	76,0
k	113,0	113,0
ø l	88,0	88,0
m	7,0	7,0
Cond. mm² min	6	6
Cond. mm² max	25	25

4 MB 267

Panel Mounting Socket Outlet

- Screw terminals
- Flange 120 x 120 mm
- High-temperature-resistant contact carrier
- Kontex contact
- Nickel plated contacts
- Box terminals
- Protection degree IP67
- Products with PILOT please add "P" to the ref.no.



13451

Ampere	Poles	110V	230V	400V	500V	>50V	>50V	Quantity	Each
		50-60 Hz	50-60 Hz	50-60 Hz	50-60 Hz	100-300Hz	301-500Hz		
125	3	13445	13452					5	930
125	4		13449	13447	13448			5	1005
125	5			13451				5	1125

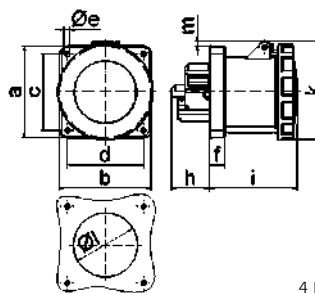

Ampere Poles	125 3	125 4	125 5
a	120,0	120,0	120,0
b	120,0	120,0	120,0
c	100,0	100,0	100,0
d	100,0	100,0	100,0
ø e	6,5	6,5	6,5
f	21,0	21,0	21,0
h	50,0	50,0	50,0
i	117,0	117,0	117,0
k	129,0	129,0	129,0
ø l	104,0	104,0	104,0
m	6,0	6,0	6,0
Cond. mm² min	25	25	25
Cond. mm² max	70	70	70

4 MB 55

Panel Mounting Socket Outlet

- Screw terminals
- Flange 130 x 130 mm
- High-temperature-resistant contact carrier
- Kontex contact
- Nickel plated contacts
- Box terminals
- Protection degree IP67
- Products with PILOT please add "P" to the ref.no.



110V
50-60 Hz
3pol 4pol 5pol
4h 4h 4h

230V
50-60 Hz
3pol 4pol 5pol
6h 9h 9h

400V
50-60 Hz
3pol 4pol 5pol
9h 6h 6h

500V
50-60 Hz
3pol 4pol 5pol
7h 7h 7h

>50V
100-300Hz
3pol 4pol 5pol
10h 10h 10h

>50V
301-500Hz
3pol 4pol 5pol
2h 2h 2h

Quantity Each

125	3	13434			5	965
125	4	13442	13435	13515	5	1040
125	5		13436		5	1140



13436

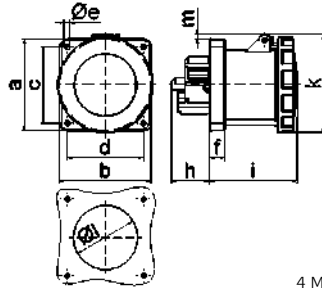

4 MB 55

Ampere Poles	125 3	125 4	125 5
a	130,0	130,0	130,0
b	130,0	130,0	130,0
c	104,0	104,0	104,0
d	104,0	104,0	104,0
ø e	6,5	6,5	6,5
f	21,0	21,0	21,0
h	50,0	50,0	50,0
i	117,0	117,0	117,0
k	129,0	129,0	129,0
ø l	104,0	104,0	104,0
m	1,0	1,0	1,0
Cond. mm² min	25	25	25
Cond. mm² max	70	70	70

Panel Mounting Socket Outlet QUICK-CONNECT

- Screwless terminals
- 20° angled
- Kontex contact
- Flange 68 x 62 mm for 16A 3p, 75 x 75 mm for 16A 5p
- Protection degree IP67



110V
50-60 Hz
3pol 4pol 5pol
4h 4h 4h

230V
50-60 Hz
3pol 4pol 5pol
6h 9h 9h

400V
50-60 Hz
3pol 4pol 5pol
9h 6h 6h

500V
50-60 Hz
3pol 4pol 5pol
7h 7h 7h

>50V
100-300Hz
3pol 4pol 5pol
10h 10h 10h

>50V
301-500Hz
3pol 4pol 5pol
2h 2h 2h

Quantity Each

16	3	12808	12809		10	125
16	5	12810	12811	12812	10	



12812

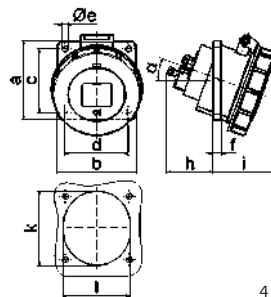

4 MB 113

Ampere Poles	16 3	16 5
a	68,0	75,0
b	62,0	75,0
c	47,0	60,0
d	47,0	60,0
ø e	5,5	5,5
f	8,0	5,5
h	46,0	46,0
i	57,0	60,0
k	56,0	70,0
l	51,0	63,0
α	20°	20°
Cond. mm² min	1,5	1,5
Cond. mm² max	4	4

Panel Mounting Socket Outlet QUICK-CONNECT

- Screwless terminals
- 20° angled
- Kontex contact
- Flange 85 x 85 mm
- Protection degree IP67



110V
50-60 Hz
3pol 4pol 5pol
4h 4h 4h

230V
50-60 Hz
3pol 4pol 5pol
6h 9h 9h

400V
50-60 Hz
3pol 4pol 5pol
9h 6h 6h

500V
50-60 Hz
3pol 4pol 5pol
7h 7h 7h

>50V
100-300Hz
3pol 4pol 5pol
10h 10h 10h

>50V
301-500Hz
3pol 4pol 5pol
2h 2h 2h

Quantity Each

16	3	12917	12813		10	150
16	4		12929	12814	12930	10 170
16	5	12815	12816	12817	10	200
32	3	12818	12819		10	230
32	4		12820	12821	12931	10 255
32	5	12822	12823	12824	10	310



12817

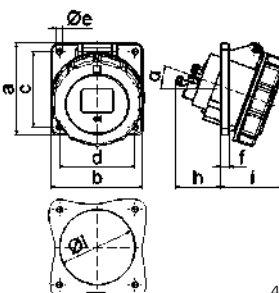

4 MB 114

Ampere Poles	16 3	16 4	16 5	32 3	32 4	32 5
a	85,0	85,0	85,0	85,0	85,0	85,0
b	85,0	85,0	85,0	85,0	85,0	85,0
c	70,0	70,0	70,0	70,0	70,0	70,0
d	70,0	70,0	70,0	70,0	70,0	70,0
ø e	5,5	5,5	5,5	5,5	5,5	5,5
f	8,0	8,0	8,0	8,0	8,0	8,0
h	46,0	46,0	46,0	55,0	55,0	55,0
i	57,0	57,0	60,0	65,0	65,0	69,0
ø l	57,0	65,0	70,0	78,0	78,0	78,0
α	20°	20°	20°	20°	20°	20°
Cond. mm² min	1,5	1,5	1,5	2,5	2,5	2,5
Cond. mm² max	4	4	4	10	10	10

Panel Mounting Socket Outlet QUICK-CONNECT

- Screwless terminals
- 20° angled
- Kontex contact
- Flange 74 x 62 mm for 16A 3p, 100 x 92 mm for the other versions
- Protection degree IP67

QUICK CONNECT



12839

Ampere	Poles	110V 50-60 Hz	230V 50-60 Hz	400V 50-60 Hz	500V 50-60 Hz	>50V 100-300Hz	>50V 301-500Hz	Quantity	Each
		3pol 4pol 5pol 4h 4h 4h	3pol 4pol 5pol 6h 9h 9h	3pol 4pol 5pol 9h 6h 6h	3pol 4pol 5pol 7h 7h 7h	3pol 4pol 5pol 10h 10h 10h	3pol 4pol 5pol 2h 2h 2h		
16	3	12825	12826					10	125
16	4	12831	12832	12833	12834	12835	12836	10	175
16	5	12837	12838	12839	12840	12841	12842	10	195
32	3	12843	12844					10	215
32	4	12846	12847	12848	12849	12850	12851	10	240
32	5	12852	12853	12854	12855	12856	12857	10	285

Ampere	Poles	16	16	16	32	32	32
a	74,0	100,0	100,0	100,0	100,0	100,0	100,0
b	62,0	92,0	92,0	92,0	92,0	92,0	92,0
c	60,0	85,0	85,0	85,0	85,0	85,0	85,0
d	52,0	77,0	77,0	77,0	77,0	77,0	77,0
ø e	5,5	5,5	5,5	5,5	5,5	5,5	5,5
f	8,0	8,0	8,0	8,0	8,0	8,0	8,0
h	46,0	46,0	46,0	55,0	55,0	55,0	55,0
i	57,0	57,0	60,0	65,0	65,0	69,0	69,0
k	57,0	65,0	70,0	75,0	75,0	78,0	78,0
l	52,0	65,0	70,0	75,0	75,0	78,0	78,0
α	20°	20°	20°	20°	20°	20°	20°
Cond. mm² min	1,5	1,5	1,5	2,5	2,5	2,5	2,5
Cond. mm² max	4	4	4	10	10	10	10

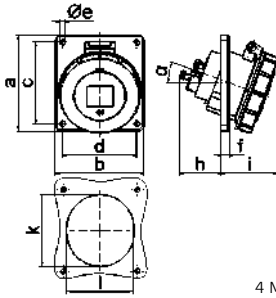

4 MB 115

Panel Mounting Socket Outlet

- Screw terminals
- 15° angled
- Flange 100 x 92 mm
- Kontex contact
- Nickel plated contacts
- Box terminals
- Protection degree IP67
- Products with PILOT please add "P" to the ref.no.



12574

Ampere	Poles	110V 50-60 Hz	230V 50-60 Hz	400V 50-60 Hz	500V 50-60 Hz	>50V 100-300Hz	>50V 301-500Hz	Quantity	Each
		3pol 4pol 5pol 4h 4h 4h	3pol 4pol 5pol 6h 9h 9h	3pol 4pol 5pol 9h 6h 6h	3pol 4pol 5pol 7h 7h 7h	3pol 4pol 5pol 10h 10h 10h	3pol 4pol 5pol 2h 2h 2h		
63	3		12569					10	445
63	4		12032	12570	12571			10	480
63	5	12572	12573	12574				10	525

Ampere	Poles	63	63	63
a	100,0	100,0	100,0	100,0
b	92,0	92,0	92,0	92,0
c	85,0	85,0	85,0	85,0
d	77,0	77,0	77,0	77,0
ø e	6,5	6,5	6,5	6,5
f	12,0	12,0	12,0	12,0
h	65,0	65,0	65,0	65,0
i	80,0	80,0	80,0	80,0
k	80,0	80,0	80,0	80,0
l	92,0	92,0	92,0	92,0
Cond. mm² min	6	6	6	6
Cond. mm² max	25	25	25	25

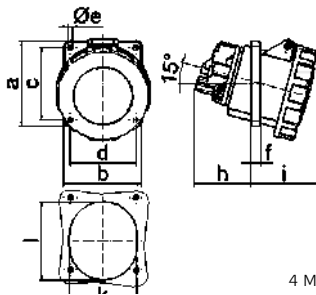

4 MB 65

Panel Mounting Socket Outlet QUICK-CONNECT TE

- Screwless terminals
- 15° angled
- Flange 100 x 92 mm
- High-temperature-resistant contact carrier
- Kontex contact
- Nickel plated contacts
- Box terminals
- Protection degree IP67



120274

Ampere	Poles	110V 50-60 Hz	230V 50-60 Hz	400V 50-60 Hz	500V 50-60 Hz	>50V 100-300Hz	>50V 301-500Hz	Quantity	Each
		3pol 4pol 5pol 4h 4h 4h	3pol 4pol 5pol 6h 9h 9h	3pol 4pol 5pol 9h 6h 6h	3pol 4pol 5pol 7h 7h 7h	3pol 4pol 5pol 10h 10h 10h	3pol 4pol 5pol 2h 2h 2h		
63	4			120320	120342			10	630
63	5			120274				10	645

Ampere	Poles	63	63
a	100,0	100,0	100,0
b	92,0	92,0	92,0
c	85,0	85,0	85,0
d	77,0	77,0	77,0
ø e	6,5	6,5	6,5
f	12,0	12,0	12,0
h	74,0	74,0	74,0
i	80,0	80,0	80,0
k	80,0	80,0	80,0
l	92,0	92,0	92,0
Cond. mm² min	6	6	6
Cond. mm² max	25	25	25

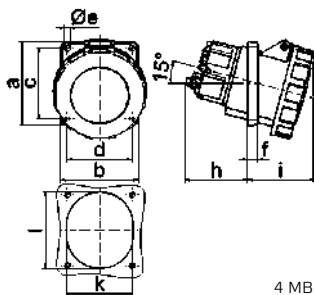

4 MB 268

Panel Mounting Socket Outlet

- Screw terminals
- 15° angled
- Flange 114 x 114 mm
- Kontex contact
- Nickel plated contacts
- Box terminals
- Protection degree IP67
- Products with PILOT please add "P" to the ref.no.



129

Ampere	Poles	110V 50-60 Hz	230V 50-60 Hz	400V 50-60 Hz	500V 50-60 Hz	>50V 100-300Hz	>50V 301-500Hz	Quantity	Each
		3pol 4pol 5pol 4h 4h 4h	3pol 4pol 5pol 6h 9h 9h	3pol 4pol 5pol 9h 6h 6h	3pol 4pol 5pol 7h 7h 7h	3pol 4pol 5pol 10h 10h 10h	3pol 4pol 5pol 2h 2h 2h		
63	3	12000	12001	12002				5	475
63	4	12003	1205	1200	1203	12035	12233	5	510
63	5	12004	1206	129	12039	12389	12171	5	550

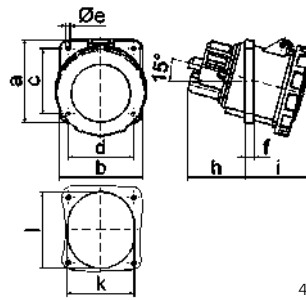

4 MB 9

Ampere	63	63	63
Poles	3	4	5
a	114,0	114,0	114,0
b	114,0	114,0	114,0
c	90,0	90,0	90,0
d	90,0	90,0	90,0
ø e	6,5	6,5	6,5
f	12,0	12,0	12,0
h	65,0	65,0	65,0
i	80,0	80,0	80,0
k	92,0	92,0	92,0
l	92,0	92,0	92,0
Cond. mm² min	6	6	6
Cond. mm² max	25	25	25

1

2

3

Panel Mounting Socket Outlet QUICK-CONNECT TE

- Screwless terminals
- 15° angled
- Flange 114 x 114 mm
- High-temperature-resistant contact carrier
- Kontex contact
- Nickel plated contacts
- Box terminals
- Protection degree IP67



120307

Ampere	Poles	110V 50-60 Hz	230V 50-60 Hz	400V 50-60 Hz	500V 50-60 Hz	>50V 100-300Hz	>50V 301-500Hz	Quantity	Each
		3pol 4pol 5pol 4h 4h 4h	3pol 4pol 5pol 6h 9h 9h	3pol 4pol 5pol 9h 6h 6h	3pol 4pol 5pol 7h 7h 7h	3pol 4pol 5pol 10h 10h 10h	3pol 4pol 5pol 2h 2h 2h		
63	4			120322	120387			5	625
63	5			120307				5	670

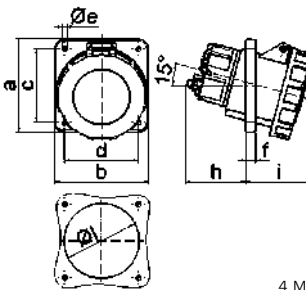

4 MB 270

Ampere	63	63
Poles	4	5
a	114,0	114,0
b	114,0	114,0
c	90,0	90,0
d	90,0	90,0
ø e	6,5	6,5
f	12,0	12,0
h	74,0	74,0
i	80,0	80,0
ø l	92,0	92,0
Cond. mm² min	6	6
Cond. mm² max	25	25

4

5

Panel Mounting Socket Outlet

- Screw terminals
- 15° angled
- Flange 114 x 114 mm
- High-temperature-resistant contact carrier
- Nickel plated contacts
- Kontex contact
- Box terminals
- Protection degree IP67
- Products with PILOT please add "P" to the ref.no.



12108

Ampere	Poles	110V 50-60 Hz	230V 50-60 Hz	400V 50-60 Hz	500V 50-60 Hz	>50V 100-300Hz	>50V 301-500Hz	Quantity	Each
		3pol 4pol 5pol 4h 4h 4h	3pol 4pol 5pol 6h 9h 9h	3pol 4pol 5pol 9h 6h 6h	3pol 4pol 5pol 7h 7h 7h	3pol 4pol 5pol 10h 10h 10h	3pol 4pol 5pol 2h 2h 2h		
125	3	1299	12100	12101				5	805
125	4	12102	12103	12104	12105	12320	12278	5	885
125	5	12106	12107	12108	12133	12334	12055	5	980

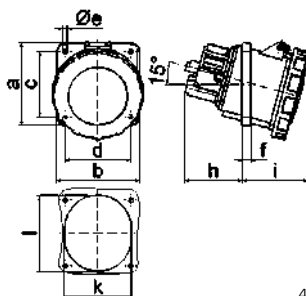

4 MB 9

Ampere	125	125	125
Poles	3	4	5
a	114,0	114,0	114,0
b	114,0	114,0	114,0
c	90,0	90,0	90,0
d	90,0	90,0	90,0
ø e	6,5	6,5	6,5
f	12,0	12,0	12,0
h	82,0	82,0	82,0
i	90,0	90,0	90,0
k	92,0	92,0	92,0
l	105,0	105,0	105,0
Cond. mm² min	25	25	25
Cond. mm² max	70	70	70

6

7

Panel Mounting Socket Outlet QUICK-CONNECT TE

- Screwless terminals
- Angled
- With NO and NC contact
- Flange 85 x 85 mm
- High-temperature-resistant contact carrier
- Nickel plated contacts
- Protection degree IP44

QUICK CONNECT



120587

Ampere	Poles	110V 50-60 Hz	230V 50-60 Hz	400V 50-60 Hz	500V 50-60 Hz	>50V 100-300Hz	>50V 301-500Hz	Quantity	Each
		3pol 4pol 5pol 4h 4h 4h	3pol 4pol 5pol 6h 9h 9h	3pol 4pol 5pol 9h 6h 6h	3pol 4pol 5pol 7h 7h 7h	3pol 4pol 5pol 10h 10h 10h	3pol 4pol 5pol 2h 2h 2h		
16	3	120583	120584					10	140
16	4			120585	120586			10	155
16	5			120587				10	195
32	3	120588	120589					10	265
32	4			120590	120591			10	225
32	5			120592				10	265

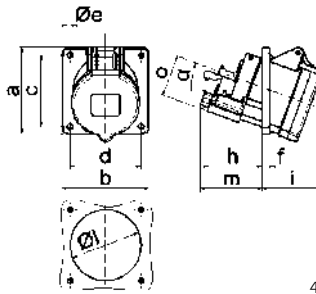

Ampere Poles	16 3	16 4	16 5	32 3	32 4	32 5
a	85,0	85,0	85,0	85,0	85,0	85,0
b	85,0	85,0	85,0	85,0	85,0	85,0
c	70,0	70,0	70,0	70,0	70,0	70,0
d	70,0	70,0	70,0	70,0	70,0	70,0
e	5,5	5,5	5,5	5,5	5,5	5,5
f	8,0	8,0	8,0	8,0	8,0	8,0
h	46,0	46,0	46,0	61,0	61,0	61,0
i	50,0	51,0	54,0	60,0	60,0	60,0
l	57,0	65,0	70,0	78,0	78,0	78,0
m	57,0	57,0	58,0	62,0	62,0	63,0
o	34,0	37,0	41,0	42,0	42,0	44,0
α	20°	20°	20°	20°	20°	20°

4 MB 76

Panel Mounting Socket Outlet QUICK-CONNECT TE

- Screwless terminals
- Angled
- With NO and NC contact
- Flange 85 x 85 mm
- High-temperature-resistant contact carrier
- Nickel plated contacts
- Protection degree IP67

QUICK CONNECT



12650

Ampere	Poles	110V 50-60 Hz	230V 50-60 Hz	400V 50-60 Hz	500V 50-60 Hz	>50V 100-300Hz	>50V 301-500Hz	Quantity	Each
		3pol 4pol 5pol 4h 4h 4h	3pol 4pol 5pol 6h 9h 9h	3pol 4pol 5pol 9h 6h 6h	3pol 4pol 5pol 7h 7h 7h	3pol 4pol 5pol 10h 10h 10h	3pol 4pol 5pol 2h 2h 2h		
16	3	12648	121317					10	170
16	4			12649	12653			10	
16	5			12650				10	
32	3	12651	12646					10	270
32	4			12555	12652			10	
32	5			12596				10	355

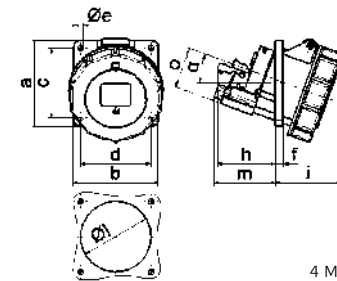

Ampere Poles	16 3	16 4	16 5	32 3	32 4	32 5
a	85,0	85,0	85,0	85,0	85,0	85,0
b	85,0	85,0	85,0	85,0	85,0	85,0
c	70,0	70,0	70,0	70,0	70,0	70,0
d	70,0	70,0	70,0	70,0	70,0	70,0
e	5,5	5,5	5,5	5,5	5,5	5,5
f	8,0	8,0	8,0	8,0	8,0	8,0
h	46,0	46,0	46,0	55,0	55,0	55,0
i	57,0	57,0	60,0	65,0	65,0	69,0
l	57,0	65,0	70,0	75,0	75,0	78,0
m	57,0	57,0	58,0	62,0	62,0	63,0
o	34,0	37,0	41,0	42,0	42,0	44,0
α	20°	20°	20°	20°	20°	20°

4 MB 78

Panel Mounting Socket Outlet

- Screw terminal
- 15° angled
- Flange 114 x 114 mm
- Drilling hole distance 90 x 90 mm
- With PSC-locking
- Kontex-Plus
- Box terminals
- Protection degree IP44



12616

Ampere	Poles	110V 50-60 Hz	230V 50-60 Hz	400V 50-60 Hz	500V 50-60 Hz	>50V 100-300Hz	>50V 301-500Hz	Quantity	Each
		3pol 4pol 5pol 4h 4h 4h	3pol 4pol 5pol 6h 9h 9h	3pol 4pol 5pol 9h 6h 6h	3pol 4pol 5pol 7h 7h 7h	3pol 4pol 5pol 10h 10h 10h	3pol 4pol 5pol 2h 2h 2h		
63	4			12360	12511			5	700
63	5			12616				5	750

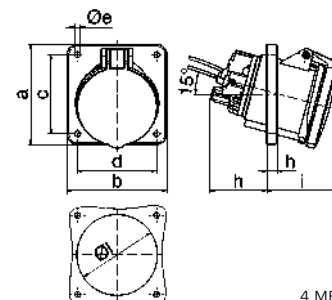

Ampere Poles	63 4	63 5
a	114,0	114,0
b	114,0	114,0
c	90,0	90,0
d	90,0	90,0
ø e	6,5	6,5
f	12,0	12,0
h	65,0	65,0
i	81,0	81,0
ø l	92,0	92,0
Cond. mm² min	6	6
Cond. mm² max	25	25

4 MB 388

Panel Mounting Socket Outlet

- 15° angled
- Flange 114 x 114 mm
- Drilling hole distance 90 x 90 mm
- With PSC-locking
- Kontex-Plus
- Box terminals
- Protection degree IP67



110V
50-60 Hz

230V
50-60 Hz

400V
50-60 Hz

500V
50-60 Hz

>50V
100-300Hz

>50V
301-500Hz



9

Ampere	Poles	12052	12053	Quantity	Each
63	4			5	760
63	5	12020		5	820
125	4	12139	12054	5	1230
125	5	12025		5	1350



12025

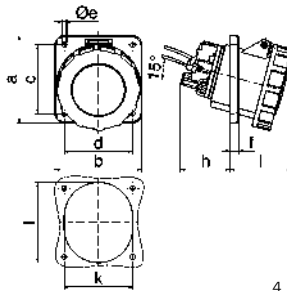

4 MB 192

Ampere	63	63	125	125
Poles	4	5	4	5
a	114,0	114,0	114,0	114,0
b	114,0	114,0	114,0	114,0
c	90,0	90,0	90,0	90,0
d	90,0	90,0	90,0	90,0
Ø e	6,5	6,5	6,5	6,5
f	12,0	12,0	12,0	12,0
h	65,0	65,0	82,0	82,0
i	81,0	81,0	90,0	90,0
k	92,0	92,0	92,0	92,0
l	92,0	92,0	105,0	105,0
Cond. mm ² min	6	6	25	25
Cond. mm ² max	25	25	70	70

1

2

3

4

5

6

7

Sockets

Panel Mounting Socket Outlets

Technical Information

- IEC 60309, EN 60309, VDE 0623
- Particularly suitable for harsh operating conditions, especially resistant to aggressive atmospheres

Panel Mounting Socket Outlet QUICK-CONNECT TE

- Screwless terminals
- Kontex contact
- Flange 75 x 75 mm
- Straight
- High-temperature-resistant contact carrier
- Nickel plated contacts
- Protection degree IP44

QUICK CONNECT



13336

Amperage	Poles	230V 50-60 Hz			400V 50-60 Hz			500V 50-60 Hz			Quantity	Each
		3pol 6h	4pol 9h	5pol 9h	3pol 9h	4pol 6h	5pol 6h	3pol 7h	4pol 7h	5pol 7h		
16	3	13144								10	110	
16	4	13476			13334			13771		10	150	
16	5				13336			130111		10	170	
32	3	13773								10	215	
32	4	13774			13775			13776		10	230	
32	5				13777					10	250	

Panel Mounting Socket Outlet TE

- Screw terminals
- Flange 107 x 100 mm
- Straight
- High-temperature-resistant contact carrier
- Kontex contact and box terminals
- Nickel plated contacts
- Protection degree IP44



13343

Amperage	Poles	230V 50-60 Hz			400V 50-60 Hz			500V 50-60 Hz			Quantity	Each
		3pol 6h	4pol 9h	5pol 9h	3pol 9h	4pol 6h	5pol 6h	3pol 7h	4pol 7h	5pol 7h		
63	3	13341								5	420	
63	4				13342			13344		5	450	
63	5				13343					5	495	

Panel Mounting Socket Outlet QUICK-CONNECT TE

- Screwless terminals
- Kontex contact
- Flange 74 x 62 mm for 16A 3p, 100 x 92 mm for the other versions
- 20° angled
- High-temperature-resistant contact carrier
- Nickel plated contacts
- Protection degree IP44

QUICK CONNECT



12884

Amperage	Poles	230V 50-60 Hz			400V 50-60 Hz			500V 50-60 Hz			Quantity	Each
		3pol 6h	4pol 9h	5pol 9h	3pol 9h	4pol 6h	5pol 6h	3pol 7h	4pol 7h	5pol 7h		
16	3	12398								10	100	
16	4	12876			12877			12878		10	150	
16	5				12401					10	165	
32	3	12880								10	205	
32	4				12882			12883		10	215	
32	5				12884					10	255	

Panel Mounting Socket Outlet TE

- Screw terminals
- Flange 114 x 114 mm
- 15° angled
- High-temperature-resistant contact carrier
- Kontex contact and box terminals
- Nickel plated contacts
- Protection degree IP44
- Products with PILOT please add "P" to the ref.no.



12408

Amperage	Poles	230V 50-60 Hz			400V 50-60 Hz			500V 50-60 Hz			Quantity	Each
		3pol 6h	4pol 9h	5pol 9h	3pol 9h	4pol 6h	5pol 6h	3pol 7h	4pol 7h	5pol 7h		
63	3	12405								5	420	
63	4				12406			12407		5	470	
63	5				12408					5	510	

Panel Mounting Socket Outlets

Technical Information

- IEC 60309, EN 60309, VDE 0623
- Particularly suitable for harsh operating conditions, especially resistant to aggressive atmospheres

Panel Mounting Socket Outlet QUICK-CONNECT TE

- Screwless terminals
- Kontex contact
- Flange 75 x 75 mm
- Straight
- High-temperature-resistant contact carrier
- Nickel plated contacts
- Protection degree IP67



13816

Amperes	Poles	230V 50-60 Hz			400V 50-60 Hz			500V 50-60 Hz			Quantity	Each
		3pol 6h	4pol 9h	5pol 9h	3pol 9h	4pol 6h	5pol 6h	3pol 7h	4pol 7h	5pol 7h		
16	3	13156						10	145			
16	4	13083			13157			13810	10	170		
16	5				13159				10	200		
32	3	13812						10	220			
32	4	13813			13814			13815	10	230		
32	5				13816				10	270		

Panel Mounting Socket Outlet TE

- Screw terminals
- Flange 107 x 100 mm
- Straight
- High-temperature-resistant contact carrier
- Kontex contact and box terminals
- Nickel plated contacts
- Protection degree IP67



13385

Amperes	Poles	230V 50-60 Hz			400V 50-60 Hz			500V 50-60 Hz			Quantity	Each
		3pol 6h	4pol 9h	5pol 9h	3pol 9h	4pol 6h	5pol 6h	3pol 7h	4pol 7h	5pol 7h		
63	3	13382						5	480			
63	4				13383			13384	5	510		
63	5				13385				5	550		

Panel Mounting Socket Outlet QUICK-CONNECT TE

- Screwless terminals
- Kontex contact
- Flange 74 x 62 mm for 16A 3p, 100 x 92 mm for the other versions
- 20° angled
- High-temperature-resistant contact carrier
- Nickel plated contacts
- Protection degree IP67



12928

Amperes	Poles	230V 50-60 Hz			400V 50-60 Hz			500V 50-60 Hz			Quantity	Each
		3pol 6h	4pol 9h	5pol 9h	3pol 9h	4pol 6h	5pol 6h	3pol 7h	4pol 7h	5pol 7h		
16	3	12205						10	145			
16	4	12919			12920			12921	10	165		
16	5	120161			12922			120159	10	205		
32	3	12924						10	225			
32	4	12925			12926			12927	10	250		
32	5	120162			12928			120158	10	300		

Panel Mounting Socket Outlet TE

- Screw terminals
- Flange 114 x 114 mm
- 15° angled
- High-temperature-resistant contact carrier
- Kontex contact and box terminals
- Nickel plated contacts
- Protection degree IP67
- Products with PILOT please add "P" to the ref.no.



12160

Amperes	Poles	230V 50-60 Hz			400V 50-60 Hz			500V 50-60 Hz			Quantity	Each
		3pol 6h	4pol 9h	5pol 9h	3pol 9h	4pol 6h	5pol 6h	3pol 7h	4pol 7h	5pol 7h		
63	3	12409						5	500			
63	4				12410			12156	5	535		
63	5				12160				5	575		

Panel Mounting Socket Outlet TE

- Screw terminals
- Flange 114 x 114 mm
- 15° angled
- High-temperature-resistant contact carrier
- Kontex contact and box terminals
- Nickel plated contacts
- Protection degree IP67
- Products with PILOT please add "P" to the ref.no.



12108

Amperes	Poles	230V 50-60 Hz			400V 50-60 Hz			500V 50-60 Hz			Quantity	Each
		3pol 6h	4pol 9h	5pol 9h	3pol 9h	4pol 6h	5pol 6h	3pol 7h	4pol 7h	5pol 7h		
125	3	12100			12101				5	905		
125	4	12103			12104			12105	5	965		
125	5	12107			12108			12133	5	1070		

Panel mounting socket outlet

- protection degree IP44
- with screw terminals for wiring through
- safe against ball throwing according DIN 18032
- nickel-plated contacts
- flange can be rotated by 180° - straight and sloping design all in one
- 16A sockets: installation also possible in customary cavity wall and concrete sockets with fixing center 67mm
- with labelling field
- Domestic sockets with screwless connection design (plug-in terminal)
- housing material: PC/ABS
- color: white similar RAL9016

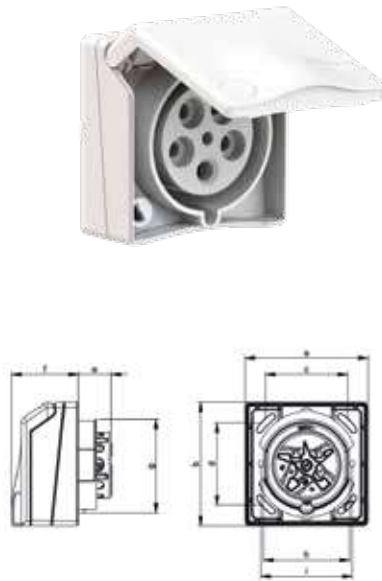

4MB465

Version	P	V	Ref. no.	Qty
16A	3	230	130010	6
16A	5	400	130011	6
32A	5	400	130012	6
Domestic socket Typ E	2 + E	250	71010	6
Domestic socket Typ F	2 + E	250	71011	6

Ampere Poles	16 3	16 4	16 5	32 5	Schutzk. Domestic
a	90,0	90,0	90,0	90,0	90,0
b	90,0	90,0	90,0	90,0	90,0
c	60,0	60,0	60,0	60,0	60,0
d	60,0	60,0	60,0	60,0	60,0
e	23,0	24,0	24,0	36,0	16,0
f	48,0	48,0	48,0	48,0	48,0
g	66,0	66,0	69,0	78,0	66,0
h	63,0	63,0	63,0	74,0	63,0
i	67,0	67,0	67,0	-	67,0
Cond. mm² min.	1,0	1,0	1,0	2,5	1,0
Cond. mm² max.	4,0	4,0	4,0	10	2,5

Surface mounting socket outlet

- protection degree IP44
- with screw terminals for wiring through
- safe against ball throwing according DIN 18032
- nickel-plated contacts
- flange can be rotated by 180° - straight and sloping design all in one
- one side entry with offset nipple, possible entry on the other with cutout
- with labelling field
- Domestic sockets with screwless connection design (plug-in terminal)
- housing material: PC/ABS
- color: white similar RAL9016

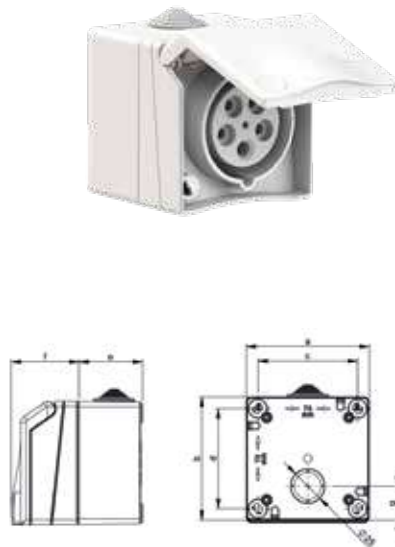

4MB463

Version	P	V	Ref. no.	Qty
16A	3	230	110710	6
16A	5	400	110711	6
32A	5	400	110712	6
Domestic socket Typ E	2 + E	250	72010	6
Domestic socket Typ F	2 + E	250	72011	6

Ampere Poles	16 3	16 4	16 5	32 5	Schutzk. Domestic
a	90,0	90,0	90,0	90,0	90,0
b	90,0	90,0	90,0	90,0	90,0
c	73,0	73,0	73,0	73,0	73,0
d	73,0	73,0	73,0	73,0	73,0
e	47,0	47,0	47,0	47,0	47,0
f	48,0	48,0	48,0	48,0	48,0
g	25,0	25,0	25,0	25,0	25,0
Cond. mm² min.	1,0	1,0	1,0	2,5	1,0
Cond. mm² max.	4,0	4,0	4,0	10	2,5

Flange can be rotated by 180° – straight and angled design all in one



Flush mounting socket outlet

- protection degree IP44
- with screw terminals for wiring through
- safe against ball throwing according DIN 18032
- nickel-plated contacts
- cable entry from top, bottom, side or rear by cutout
- in rows combinable with horizontal and vertical insertion
- with integrated cover frame and a fix inclination of 6° - small protection 35mm
- with labelling field
- Domestic sockets with screwless connection design (plug-in terminal)
- housing material: PC/ABS
- color: white similar RAL9016

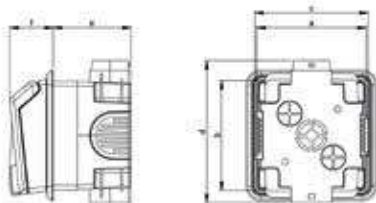

4MB464

Version	P	V	Ref. no.	Qty
16A	3	230	1410	6
16A	5	400	1411	6
32A	5	400	1412	6
Domestic socket Typ E	2 + E	250	71012	6
Domestic socket Typ F	2 + E	250	71013	6

Ampere Poles	16 3	16 4	16 5	32 5	Schutzk. Domestic
a	90,0	90,0	90,0	90,0	90,0
b	90,0	90,0	90,0	90,0	90,0
c	92,0	92,0	92,0	92,0	92,0
d	115,0	115,0	115,0	115,0	115,0
e	64,0	64,0	64,0	64,0	64,0
f	35,0	35,0	35,0	35,0	35,0
Cond. mm² min.	1,0	1,0	1,0	2,5	1,0
Cond. mm² max.	4,0	4,0	4,0	10	2,5

Cylinder lock

- for all sockets of architecture programme
- 2 keys include
- fast and easy installation of the lock by loose locking outbreaks in the hinged lid



Ref. no.	Qty
18010	6

Mounting Frame

- For attaching panel mounting socket outlets



1843

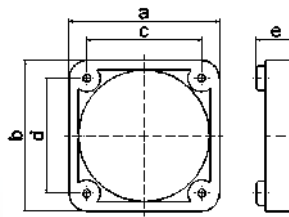

30 MB 182

a	b	c	d	e	Ref-No.
50	50	38	38	13	1843
54	54	44	44	10	1847
57	66	47	47	10	1848
60	60	50	50	10	1849
62	62	52	52	10	1850
62	70	52	60	10	1851

Mounting Frame

- For attaching panel mounting socket outlets

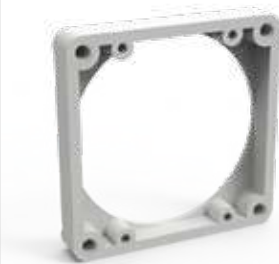

187

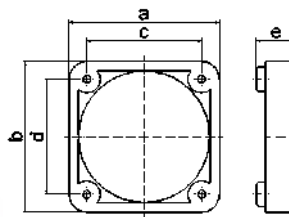

30 MB 182

a	b	c	d	e	Ref-No.
70	70	60	60	12	187
71	80	52	70	10	1852
80	80	70	70	13	189
87	95	77	85	12	188
100	110	90	90	10	1854

Intermediate Flange

- For attaching panel mounting socket outlets (straight)
- With screw terminal
- For QUICK-CONNECT 16A Panel Mounting Socket Outlets
- With flange 75 x 75 mm
- Drilling space 60 x 60 mm

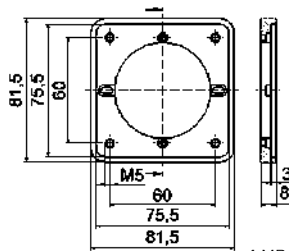

4 MB 256

	Ref-No.
	182

Flush Mounting Box

- With 4 screws
- Color lightgrey
- Can be lined up horizontally, plugged in vertically

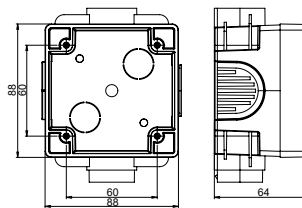

	Ref-No.
	1801

Empty Enclosure

- Dimension of enclosure 102 x 102 mm
- For panel mounting socket outlets with flange 75 x 75 mm
- Drilling spacing 60 x 60 mm



	Ref-No.
für socket IP44	18048
für socket IP67	18049

Accessories for TK-Combi
Socket Outlet



	Ref-No.
Wiring harness 16A	1863
Wiring harness 32A	1896
G-fuse base 5x20mm DIN 41671	1862
G-fuse link 6,3A	1864
G-fuse link 10A	1865
G-fuse link 16A	1866
replacement hinged lid domestic socket	33010594

1

2

3

4

5

6

7





1

2

3

4

5

6

7

Plugs

Protection Degree IP44 / IP54  Page 86	Protection Degree IP67  Pages 87 - 88	Lockable  Page 88	Angled Plugs  Page 88
---	--	--	---

Inlets

Surface Mounting Appliance Inlets  Pages 89 - 94	Panel Mounting Appliance Inlets  Pages 95 - 98	Appliance Inlets with Flange  Pages 99 - 102	Appliance Inlets with Flange for Harsh Conditions  Page 103
---	---	---	---

Phase Inverters

Plug  Page 104	Surface Mounting Appliance Inlet  Page 104	Panel Mounting Appliance Inlets  Page 104 - 105	Appliance Inlet with Flange  Page 105
--	--	---	--

Phase Sequence Indicators and Adapters

Phase Sequence Indicators  Page 106	Adapters  Page 106
--	---

Connectors

Protection Degree IP44 / IP54  Page 107	Protection Degree IP67  Pages 108 - 109	Hanging Connectors  Page 109	Lockable  Page 109
Accessories Plugs and Connectors  Page 110			

Technical features

**Plugs and Connectors with  MULTI GRIP**

- Cable gland system with integrated strain relief
- Captive rubber seal
- MULTI-GRIP cable glands achieve at least protection class IP67
- Adaptation to all cable cross sections
- Status can be checked at any time from outside

**Plugs and Connectors with  QUICK CONNECT 16A and 32A**

- Patented, screwless quick connection technology, based on the familiar spring-clamp principle, with fully opened connection cavity
- Time saving up to 75%
- Faster, more reliable and controlled conductor connection
- The terminal accepts all types of copper conductors
- Quick-Connect is maintenance-free, shock resistant, vibrations and temperature fluctuations

**Plugs and Connectors with  QUICK CONNECT 63A**

- Worldwide unique screwless system for 63A CEE devices
- Same advantages as for the 16A and 32A systems
- Screwless box terminals
- Cable cross sections for flexible conductors: 6mm² - 16mm²
- Cable cross sections for rigid and multi-wire conductors: 6mm² - 25mm²

The following types of copper conductor can be used

- Fine-wire
- Single-wire
- Finely stranded with wire end ferrules
- With gas-tight crimp
- Ultrasonically welded

Plug INNOLINQ

- Screwless terminals
- Screwless enclosure connection, self locking
- Special gland, simultaneous cable gland and seal
- Protection degree IP54
- Contact carrier is made of high temperature resistant material
- Contains no lead

- QUICK CONNECT
- KONTEX ULTRA
- MULTI GRIP



201

Ampere	Poles	110V 50-60 Hz	230V 50-60 Hz	400V 50-60 Hz	500V 50-60 Hz	>50V 100-300Hz	>50V 301-500Hz	Quantity	Each
		3pol 4pol 5pol 4h 4h 4h	3pol 4pol 5pol 6h 9h 9h	3pol 4pol 5pol 9h 6h 6h	3pol 4pol 5pol 7h 7h 7h	3pol 4pol 5pol 10h 10h 10h	3pol 4pol 5pol 2h 2h 2h		
16	3	210	211	212	21189	21658	21062	10	105
16	4	213	214	215	216	217	218	10	130
16	5	2110	211	200	21168	21150	21198	10	158
32	3	2113	2114	2115	210120	21301	210122	10	268
32	4	2116	2117	2118	2119	2120	2121	10	286
32	5	2122	2123	201	21174	210133	21052	10	312

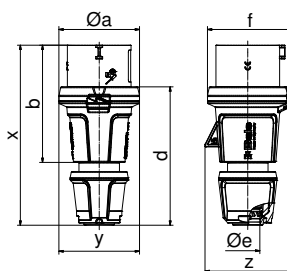

Ampere	16	16	16	32	32	32
Polzahl	3	4	5	3	4	5
ø a	59,0	71,0	71,0	80,0	80,0	80,0
b	94,0	103,0	103,0	124,0	124,0	124,0
d	109,0	123,0	123,0	145,0	145,0	145,0
ø e	18,0	21,0	21,0	29,0	29,0	29,0
f	63,0	76,0	76,0	85,0	85,0	85,0
x	145,0	160,0	160,0	191,0	191,0	191,0
y	59,0	71,0	71,0	80,0	80,0	80,0
z	64,0	76,0	78,0	85,0	85,0	89,0
Cond. mm² min	1	1	1	2,5	2,5	2,5
Cond. mm² max	2,5	2,5	2,5	6,0	6,0	6,0

2 MB 99

Plug TE-Plus with MULTI-GRIP

- Screwless terminals
- High-temperature-resistant contact carrier
- Nickel plated contacts
- Special gland, simultaneous cable gland and seal
- Protection degree IP44

- QUICK CONNECT
- MULTI GRIP



21689

Ampere	Poles	110V 50-60 Hz	230V 50-60 Hz	400V 50-60 Hz	500V 50-60 Hz	>50V 100-300Hz	>50V 301-500Hz	Quantity	Each
		3pol 4pol 5pol 4h 4h 4h	3pol 4pol 5pol 6h 9h 9h	3pol 4pol 5pol 9h 6h 6h	3pol 4pol 5pol 7h 7h 7h	3pol 4pol 5pol 10h 10h 10h	3pol 4pol 5pol 2h 2h 2h		
16	3	21837	21686	21843	210169	210170	210171	10	125
16	4	21872	21839	21687	21688	21847	21849	10	145
16	5	210176	21840	21689	210178	210179	21879	10	180
32	3	21838	21690	21844	210184	210185	210186	10	240
32	4	21873	21841	21691	21692	21848	21850	10	260
32	5	210193	21842	21693	21623	210197	21885	10	310

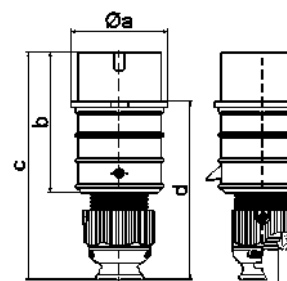

Ampere	16	16	16	32	32	32
Polzahl	3	4	5	3	4	5
ø a	51,0	57,5	65,0	66,0	66,0	72,0
b	95,0	95,0	97,0	118,0	118,0	117,0
c	145,0	145,0	152,0	178,0	178,0	181,0
d	109,0	109,0	116,0	133,0	133,0	135,5
ø e	18,0	18,0	21,0	23,0	23,0	27,0
Cond. mm² min	1	1	1	2,5	2,5	2,5
Cond. mm² max	2,5	2,5	2,5	6	6	6

2 MB 93

Plug TE with MULTI-GRIP

- Nickel plated contacts
- Special gland, simultaneous cable gland and seal
- Screwless enclosure connection, self locking
- Protection degree IP44

- MULTI GRIP



2155

Ampere	Poles	110V 50-60 Hz	230V 50-60 Hz	400V 50-60 Hz	500V 50-60 Hz	>50V 100-300Hz	>50V 301-500Hz	Quantity	Each
		3pol 4pol 5pol 4h 4h 4h	3pol 4pol 5pol 6h 9h 9h	3pol 4pol 5pol 9h 6h 6h	3pol 4pol 5pol 7h 7h 7h	3pol 4pol 5pol 10h 10h 10h	3pol 4pol 5pol 2h 2h 2h		
63	4			210761	210763			5	660
63	5			210765				5	720
Screw terminal:									
63	3	21024	2104	21025	210030	21531	21624	5	535
63	4	2149	2150	2151	2152	21300	21526	5	595
63	5	2153	2154	2155	21167	21663	21419	5	650

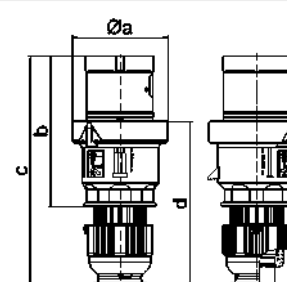

Ampere	63	63	63
Polzahl	3	4	5
ø a	96,0	96,0	96,0
b	153,0	153,0	153,0
c	233,0	233,0	233,0
d	167,0	167,0	167,0
ø e	36,0	36,0	36,0
Cond. mm² min	6	6	6
Cond. mm² max	16	16	16

2 MB 158

Plug TE-Plus with MULTI-GRIP

- Screwless terminals
- High-temperature-resistant contact carrier
- Nickel plated contacts
- Special gland, simultaneous cable gland and seal
- Protection degree IP67

Accessories: Closure cap: see page 110/3

QUICK CONNECT
MULTI GRIP



21239

Ampere	Poles	110V 50-60 Hz	230V 50-60 Hz	400V 50-60 Hz	500V 50-60 Hz	>50V 100-300Hz	>50V 301-500Hz	Quantity	Each
		3pol 4pol 5pol 4h 4h 4h	3pol 4pol 5pol 6h 9h 9h	3pol 4pol 5pol 9h 6h 6h	3pol 4pol 5pol 7h 7h 7h	3pol 4pol 5pol 10h 10h 10h	3pol 4pol 5pol 2h 2h 2h		
16	3	21237	21238	21402	21487	21453	21558	10	150
16	4	21403	21250	21349	21350	21404	21405	10	175
16	5	21406	21407	21239	21754	21564	21533	10	215
32	3	21408	21240	21409	21486	21545	210222	10	285
32	4	21410	21251	21351	21352	21411	21412	10	335
32	5	21413	21414	21241	21282	21484	210234	10	385

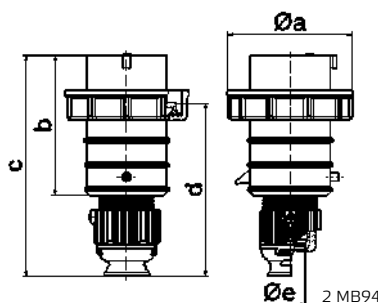

Ampere	16	16	16	32	32	32
Poles	3	4	5	3	4	5
ø a	70,0	78,0	86,0	94,0	94,0	101,0
b	95,0	95,0	97,0	118,0	118,0	117,0
c	145,0	145,0	152,0	178,0	178,0	181,0
d	111,0	111,0	119,0	136,0	136,0	138,5
ø e	18,0	18,0	21,0	23,0	23,0	27,0
Cond. mm² min	1	1	1	2,5	2,5	2,5
Cond. mm² max	2,5	2,5	2,5	6	6	6

Plug with MULTI-GRIP

- Screw terminals
- Nickel plated contacts
- One-piece enclosure
- Special gland, simultaneous cable gland and seal
- Protection degree IP67

MULTI GRIP



210589

Ampere	Poles	110V 50-60 Hz	230V 50-60 Hz	400V 50-60 Hz	500V 50-60 Hz	>50V 100-300Hz	>50V 301-500Hz	Quantity	Each
		3pol 4pol 5pol 4h 4h 4h	3pol 4pol 5pol 6h 9h 9h	3pol 4pol 5pol 9h 6h 6h	3pol 4pol 5pol 7h 7h 7h	3pol 4pol 5pol 10h 10h 10h	3pol 4pol 5pol 2h 2h 2h		
16	3	210575	210576	210577	210578	210579	210580	10	155
16	4	210581	210582	210583	210584	210585	210586	10	170
16	5	210587	210588	210589	210590	210591	210592	10	170
32	3	210593	210594	210595	210596	210597	210598	10	243
32	4	210599	210600	210601	210602	210603	210604	10	255
32	5	210605	210606	210607	210608	210609	210610	10	305

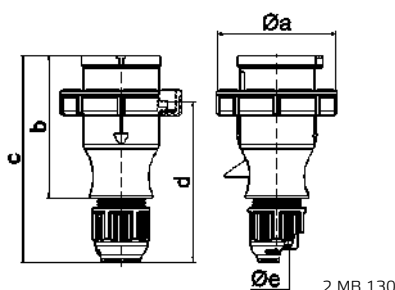

Ampere	16	16	16	32	32	32
Poles	3	4	5	3	4	5
ø a	70,0	78,0	86,0	94,0	94,0	101,0
b	94,5	98,0	101,0	115,0	115,0	119,0
c	138,0	142,0	145,0	170,0	170,0	174,0
d	105,5	109,5	112,5	128,0	128,0	132,0
ø e	18,0	18,0	18,0	23,0	23,0	23,0
Cond. mm² min	1	1	1	2,5	2,5	2,5
Cond. mm² max	2,5	2,5	2,5	6	6	6

Plug TE-Plus with MULTI-GRIP

- High-temperature-resistant contact carrier
- Nickel plated contacts
- Special gland, simultaneous cable gland and seal
- Screwless enclosure connection, self locking
- Protection degree IP67

Accessories: Closure cap: see page 110/3

MULTI GRIP



210766

Ampere	Poles	110V 50-60 Hz	230V 50-60 Hz	400V 50-60 Hz	500V 50-60 Hz	>50V 100-300Hz	>50V 301-500Hz	Quantity	Each
		3pol 4pol 5pol 4h 4h 4h	3pol 4pol 5pol 6h 9h 9h	3pol 4pol 5pol 9h 6h 6h	3pol 4pol 5pol 7h 7h 7h	3pol 4pol 5pol 10h 10h 10h	3pol 4pol 5pol 2h 2h 2h		
63	4			210762	210764			5	720
63	5			210766				5	770
Screw terminal:									
63	3	2180	2181	2182	21330			5	590
63	4	2183	2184	2185	2186	21154	21375	5	650
63	5	2187	2188	2189	21060	21645	21163	5	705

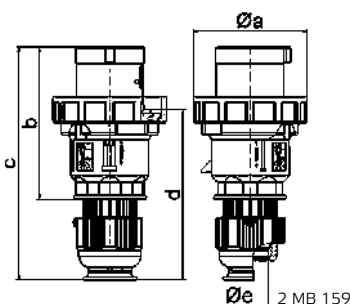

Ampere	63	63	63
Poles	3	4	5
ø a	113,5	113,5	113,5
b	153,0	153,0	153,0
c	233,0	233,0	233,0
d	171,0	171,0	171,0
ø e	36,0	36,0	36,0
Cond. mm² min	6	6	6
Cond. mm² max	16	16	16

Plugs and Connectors

Plugs Protection Degree IP44, Lockable Plugs and Angled Plugs

Technical Information

- IEC 60309-1/2, EN 60309, VDE 0623

Plug TE with MULTI-GRIP

- Screw terminals
- Box terminals
- High-temperature-resistant contact carrier
- Nickel plated contacts
- Special gland, simultaneous cable gland and seal
- Screwless enclosure connection, self locking
- Protection degree IP67

Accessories: closure cap, see page 110/3

MULTI GRIP



2199

Ampere	Poles	110V	230V	400V	500V	>50V	>50V	Quantity	Each
		50-60 Hz	50-60 Hz	50-60 Hz	50-60 Hz	100-300Hz	301-500Hz		
125	3	2190	2191	2192	210964		211133	5	1020
125	4	2193	2194	2195	2196	21607	21155	5	1125
125	5	2197	2198	2199	21555	21851	21156	5	1235

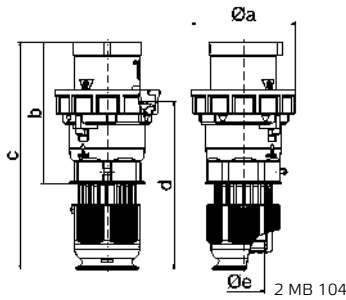

Ampere	125	125	125
Poles	3	4	5
ø a	126,0	126,0	126,0
b	181,0	181,0	181,0
c	282,0	282,0	282,0
d	206,0	206,0	206,0
ø e	50,0	50,0	50,0
Cond. mm² min	16	16	16
Cond. mm² max	50	50	50

Plug QUICK-CONNECT, lockable

- Screwless terminals
- Lockable with matching connector
- Screwless enclosure connection, self locking
- Special gland, simultaneous cable gland and seal
- Protection degree IP44

Accessories: Lock set, see page 110/5

QUICK CONNECT
MULTI GRIP



210951

Ampere	Poles	110V	230V	400V	500V	>50V	>50V	Quantity	Each
		50-60 Hz	50-60 Hz	50-60 Hz	50-60 Hz	100-300Hz	301-500Hz		
16	5			210950				10	180
32	5			210951				10	305

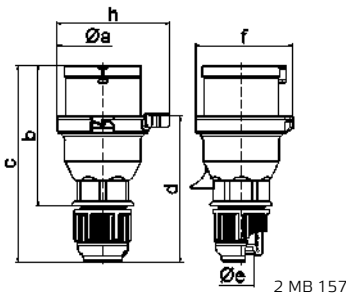

Ampere	16	32
Poles	5	5
a	66,0	74,5
b	103,0	121,5
c	142,0	174,5
d	105,5	128,5
ø e	18,0	23,0
f	70,5	80,0
h	82,0	90,0
Cond. mm² min	1	2,5
Cond. mm² max	2,5	6

Angled Plug

- Screw terminals
- With short cable sleeve
- Protection degree IP44



231

Ampere	Poles	110V	230V	400V	500V	>50V	>50V	Quantity	Each
		50-60 Hz	50-60 Hz	50-60 Hz	50-60 Hz	100-300Hz	301-500Hz		
16	3		231					10	150
16	4							10	170
16	5			236				10	175
32	5			2300-BE				10	280

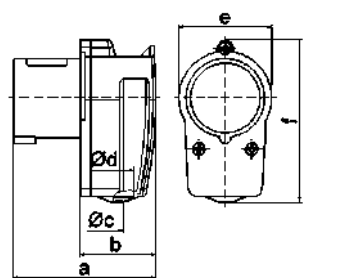

Ampere	16	16	16	32
Poles	3	4	5	5
a	80,0	85,0	96,0	116,0
b	44,0	49,0	59,0	70,0
ø c	6,5	6,5	8,0	10,0
ø d	18,0	18,0	18,0	25,0
e	51,0	57,0	64,0	-
f	90,0	95,0	74,0	101,0
Cond. mm² min	1	1	1	2,5
Cond. mm² max	2,5	2,5	2,5	6

Surface Mounting Appliance Inlet

- Screw terminals
- Cable entry 1x at top (open), 1x at bottom (closed)
- Protection degree IP44

Accessories: Closure cap, see page 110/3



240

3PHE 3PHE 3PHE		110V 50-60 Hz	230V 50-60 Hz	400V 50-60 Hz	500V 50-60 Hz	>50V 100-300Hz	>50V 301-500Hz	Quantity	Each
Ampere	Poles	3pol 4pol 5pol	3pol 4pol 5pol	3pol 4pol 5pol	3pol 4pol 5pol	3pol 4pol 5pol	3pol 4pol 5pol		
		4h 4h 4h	6h 9h 9h	9h 6h 6h	7h 7h 7h	10h 10h 10h	2h 2h 2h		
16	3	2448		240				10	115

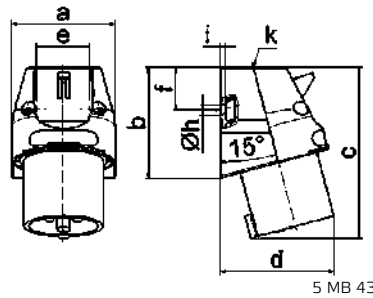

Ampere	Poles
16	3
a	56,5
b	60,0
c	93,0
d	73,0
e	29,5
f	23,5
ø h	5,5
i	3,0
k	M20
Cond. mm² min	1
Cond. mm² max	2,5

5 MB 43

Wall mounting appliance inlet INNOLINQ

- Screwless terminals
- The cable entry is one at top open and one at bottom and one rear side closed
- Protection degree IP44
- Contact carrier is made of high temperature resistant material
- Contains no lead

QUICK CONNECT
KONTEX ULTRA



24661

3PHE 3PHE 3PHE		110V 50-60 Hz	230V 50-60 Hz	400V 50-60 Hz	500V 50-60 Hz	>50V 100-300Hz	>50V 301-500Hz	Quantity	Each
Ampere	Poles	3pol 4pol 5pol	3pol 4pol 5pol	3pol 4pol 5pol	3pol 4pol 5pol	3pol 4pol 5pol	3pol 4pol 5pol		
		4h 4h 4h	6h 9h 9h	9h 6h 6h	7h 7h 7h	10h 10h 10h	2h 2h 2h		
16	3							10	170
16	4	24712	24716	24714	24713	24717	24710	10	180
16	5	24673	24677	24675	24674	24678	24671	10	200
32	3	24684	24691	24694	24690	24695	24682	10	240
32	4	24701	24705	24703	24702	24706	24699	10	260
32	5	24659	24660	24661	24667	24663	24664	10	260

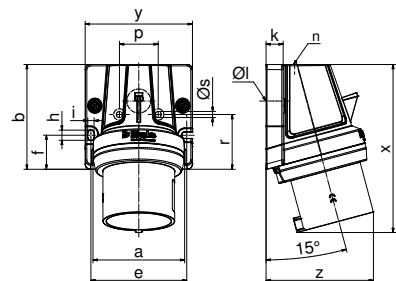

Ampere	Polzahl	16	16	32	32	32
		4	5	3	4	5
a		80,0	80,0	80,0	80,0	80,0
b		92,0	92,0	92,0	92,0	92,0
e		84,0	84,0	84,0	84,0	84,0
f		30,0	30,0	30,0	30,0	30,0
h		9,0	9,0	9,0	9,0	9,0
i		5,5	5,5	5,5	5,5	5,5
k		15,0	15,0	15,0	15,0	15,0
ø l		21,0	21,0	21,0	21,0	21,0
n		M32	M32	M32	M32	M32
x		133,0	134,0	147,0	147,0	148,0
y		94,0	94,0	94,0	94,0	94,0
z		89,0	93,0	92,0	92,0	95,0
Cond. mm² min		1,0	1,0	2,5	2,5	2,5
Cond. mm² max		4,0	4,0	10,0	10,0	10,0

Surface Mounting Appliance Inlet

- Screw terminals
- Cable entry 1x at top (open), 1x at bottom and 1x at rear (closed)
- Protection degree IP44



2415

3PHE 3PHE 3PHE		110V 50-60 Hz	230V 50-60 Hz	400V 50-60 Hz	500V 50-60 Hz	>50V 100-300Hz	>50V 301-500Hz	Quantity	Each
Ampere	Poles	3pol 4pol 5pol	3pol 4pol 5pol	3pol 4pol 5pol	3pol 4pol 5pol	3pol 4pol 5pol	3pol 4pol 5pol		
		4h 4h 4h	6h 9h 9h	9h 6h 6h	7h 7h 7h	10h 10h 10h	2h 2h 2h		
16	3	245						10	170
16	4		249					10	225
16	5		2415					10	255

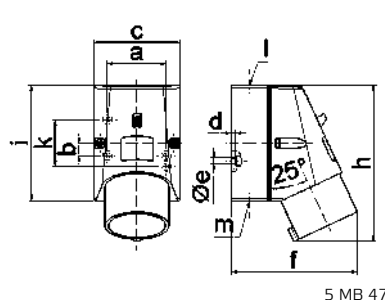

Ampere	Poles	16	16	16
		3	4	5
a		51,0	59,0	59,0
b		-	11,0	11,0
c		64,0	75,0	75,0
d		4,0	4,0	4,0
ø e		4,1	5,1	5,1
f		93,0	106,0	110,0
h		122,0	135,0	135,0
i		87,0	100,0	100,0
k		40,0	-	-
l		M20	M20	M20
m		for M20	for M20	for M20
Cond. mm² min		1	1	1
Cond. mm² max		2,5	2,5	2,5

5 MB 47

Surface Mounting Appliance Inlet QUICK-CONNECT TE

- Screwless terminals
- High-temperature-resistant contact carrier
- Nickel plated contacts
- Cable entry 1x at top (open), 2x at bottom (closed)
- Base rotatable by 180°
- 4 mounting holes in enclosure base
- Suitable for through wiring
- Protection degree IP44

QUICK CONNECT



24413

		110V 50-60 Hz	230V 50-60 Hz	400V 50-60 Hz	500V 50-60 Hz	>50V 100-300Hz	>50V 301-500Hz	Quantity	Each
Ampere	Poles	3pol 4pol 5pol 4h 4h 4h	3pol 4pol 5pol 6h 9h 9h	3pol 4pol 5pol 9h 6h 6h	3pol 4pol 5pol 7h 7h 7h	3pol 4pol 5pol 10h 10h 10h	3pol 4pol 5pol 2h 2h 2h		
16	5				24362			10	305
32	3	24408	24409					10	335
32	4		24410	24411	24412			10	350
32	5		24551	24413				10	385

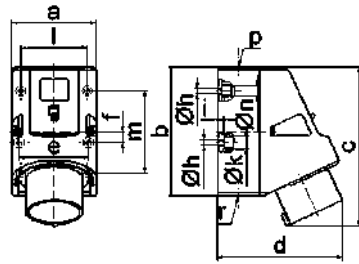

5 MB 45

Ampere	Poles	16	32	32	32
a	83,0	83,0	83,0	83,0	83,0
b	126,0	126,0	126,0	126,0	126,0
c	155,5	165,0	165,0	166,0	166,0
d	122,0	128,0	128,0	130,0	130,0
e	68,0	68,0	68,0	68,0	68,0
f	11,0	11,0	11,0	11,0	11,0
ø h	5,5	5,5	5,5	5,5	5,5
i	6,5	6,5	6,5	6,5	6,5
ø k	12,0	12,0	12,0	12,0	12,0
l	65,0	65,0	65,0	65,0	65,0
m	80,0	80,0	80,0	80,0	80,0
ø n	10,0	10,0	10,0	10,0	10,0
p	M25	M25	M25	M25	M25
r	2xM25	2xM25	2xM25	2xM25	2xM25
Cond. mm² min		1	2,5	2,5	2,5
Cond. mm² max		2,5	6	6	6

Surface Mounting Appliance Inlet

- Screw terminals
- Cable entry 1x at top (open) and 2x at bottom (closed)
- Base rotatable by 180°
- Protection degree IP44



24134

		110V 50-60 Hz	230V 50-60 Hz	400V 50-60 Hz	500V 50-60 Hz	>50V 100-300Hz	>50V 301-500Hz	Quantity	Each
Ampere	Poles	3pol 4pol 5pol 4h 4h 4h	3pol 4pol 5pol 6h 9h 9h	3pol 4pol 5pol 9h 6h 6h	3pol 4pol 5pol 7h 7h 7h	3pol 4pol 5pol 10h 10h 10h	3pol 4pol 5pol 2h 2h 2h		
63	3				24336			5	775
63	4		24337	24338	24339			5	925
63	5			24134				5	975

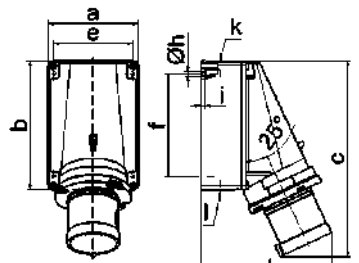

5 MB 48

Ampere	Poles	63	63	63
a	118,0	118,0	118,0	118,0
b	170,0	170,0	170,0	170,0
c	259,0	259,0	259,0	259,0
d	174,0	174,0	174,0	174,0
e	104,0	104,0	104,0	104,0
f	136,0	136,0	136,0	136,0
ø h	6,1	6,1	6,1	6,1
i	6,0	6,0	6,0	6,0
k	M40	M40	M40	M40
l	M32/32	M32/32	M32/32	M32/32
Cond. mm² min		6	6	6
Cond. mm² max		16	16	16

Surface Mounting Appliance Inlet

- Screw terminals
- With hinged lid
- Protection degree IP44

110V 50-60 Hz	230V 50-60 Hz	400V 50-60 Hz	500V 50-60 Hz	>50V 100-300Hz	>50V 301-500Hz
3pol 4pol 5pol 4h 4h 4h	3pol 4pol 5pol 6h 9h 9h	3pol 4pol 5pol 9h 6h 6h	3pol 4pol 5pol 7h 7h 7h	3pol 4pol 5pol 10h 10h 10h	3pol 4pol 5pol 2h 2h 2h
3pol 4pol 5pol 4h 4h 4h	3pol 4pol 5pol 6h 9h 9h	3pol 4pol 5pol 9h 6h 6h	3pol 4pol 5pol 7h 7h 7h	3pol 4pol 5pol 10h 10h 10h	3pol 4pol 5pol 2h 2h 2h

16 3 **242** 10 150



242

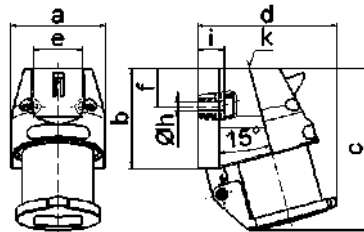

Ampere	16
Poles	3
a	56,5
b	60,0
c	97,5
d	84,0
e	29,5
f	23,0
ø h	5,5
i	16,0
k	M20
Cond. mm² min	1
Cond. mm² max	2,5

5 MB 17

Surface Mounting Appliance Inlet

- Screw terminals
- With closure cap
- Protection degree IP44

110V 50-60 Hz	230V 50-60 Hz	400V 50-60 Hz	500V 50-60 Hz	>50V 100-300Hz	>50V 301-500Hz
3pol 4pol 5pol 4h 4h 4h	3pol 4pol 5pol 6h 9h 9h	3pol 4pol 5pol 9h 6h 6h	3pol 4pol 5pol 7h 7h 7h	3pol 4pol 5pol 10h 10h 10h	3pol 4pol 5pol 2h 2h 2h
3pol 4pol 5pol 4h 4h 4h	3pol 4pol 5pol 6h 9h 9h	3pol 4pol 5pol 9h 6h 6h	3pol 4pol 5pol 7h 7h 7h	3pol 4pol 5pol 10h 10h 10h	3pol 4pol 5pol 2h 2h 2h

16 3 **2400** 10 140



2400

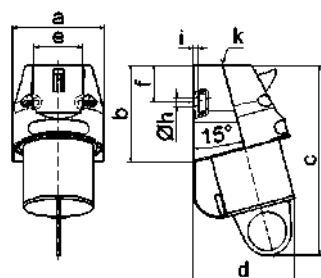

Ampere	16
Poles	3
a	56,5
b	60,0
c	118,0
d	63,0
e	29,5
f	23,0
ø h	5,5
i	3,0
k	M20
Cond. mm² min	1
Cond. mm² max	2,5

5 MB 60

Surface Mounting Appliance Inlet

- Screw terminals
- With hinged lid
- Protection degree IP44

110V 50-60 Hz	230V 50-60 Hz	400V 50-60 Hz	500V 50-60 Hz	>50V 100-300Hz	>50V 301-500Hz
3pol 4pol 5pol 4h 4h 4h	3pol 4pol 5pol 6h 9h 9h	3pol 4pol 5pol 9h 6h 6h	3pol 4pol 5pol 7h 7h 7h	3pol 4pol 5pol 10h 10h 10h	3pol 4pol 5pol 2h 2h 2h
3pol 4pol 5pol 4h 4h 4h	3pol 4pol 5pol 6h 9h 9h	3pol 4pol 5pol 9h 6h 6h	3pol 4pol 5pol 7h 7h 7h	3pol 4pol 5pol 10h 10h 10h	3pol 4pol 5pol 2h 2h 2h

16 3 **2461** 10 205

16 4 **2465** 10 255



2465

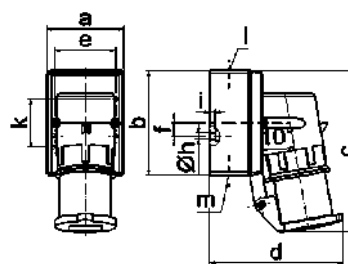

Ampere	16	16
Poles	3	4
a	64,0	75,0
b	87,0	100,0
c	138,0	150,0
d	111,0	120,0
e	51,0	59,0
f	-	11,0
ø h	4,1	5,1
i	4,5	4,5
k	40,0	-
l	M20	M20
m	for M20	for M20
Cond. mm² min	1	1
Cond. mm² max	2,5	2,5

5 MB 10

Surface Mounting Appliance Inlet

- Screw terminals
- With hinged lid
- Protection degree IP44

Ampere	Poles	110V	230V	400V	500V	>50V	>50V	Quantity	g	Each
		50-60 Hz	50-60 Hz	50-60 Hz	50-60 Hz	100-300Hz	301-500Hz			
16	5	2469	2470	2471				10	270	
32	3	24335	24017					10	335	
32	4			24018	24019			10	330	
32	5			24012				10	350	



24012

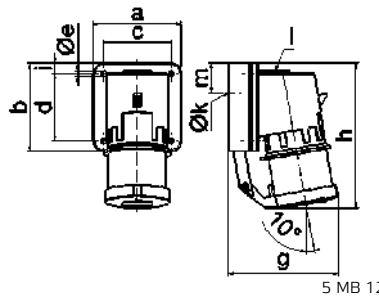

Ampere	16	32	32	32
Poles	5	3	4	5
a	84,0	90,0	90,0	90,0
b	84,0	75,0	75,0	75,0
c	64,0	78,0	78,0	78,0
d	64,0	45,0	45,0	45,0
ø e	5,5	5,5	5,5	5,5
g	105,0	114,0	114,0	115,0
h	138,0	149,0	149,0	150,0
i	10,0	13,0	13,0	13,0
ø k	23,0	29,0	29,0	29,0
l	M20	M25	M25	M25
m	28,0	27,0	27,0	27,0
Cond. mm² min	1	2,5	2,5	2,5
Cond. mm² max	2,5	6	6	6

5 MB 12

Surface Mounting Appliance Inlet QUICK-CONNECT TE

- Screwless terminals
- With hinged lid
- High-temperature-resistant contact carrier
- Nickel plated contacts
- Protection degree IP44

Ampere	Poles	110V	230V	400V	500V	>50V	>50V	Quantity	g	Each
		50-60 Hz	50-60 Hz	50-60 Hz	50-60 Hz	100-300Hz	301-500Hz			
16	5			24414				10	270	
32	5			24415				10	370	



24415

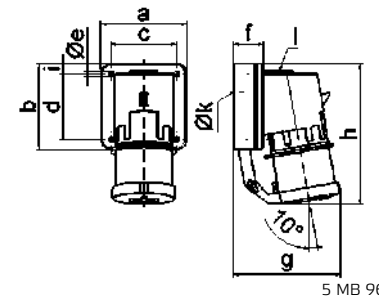

Ampere	16	32
Poles	5	5
a	84,0	90,0
b	84,0	75,0
c	64,0	78,0
d	64,0	45,0
ø e	5,5	5,5
f	29,0	29,0
g	105,0	115,0
h	138,0	150,0
i	10,0	13,0
ø k	23,0	29,0
l	M20	M25
Cond. mm² min	1	2,5
Cond. mm² max	2,5	6

5 MB 96

QUICK CONNECT

Surface Mounting Appliance Inlet

- Screw terminals
- Nickel plated contacts
- Terminal for 1 mm² to 2.5 mm² conductor for 16A
- Terminal for 2.5 mm² to 6 mm² conductor for 32A
- Protection degree IP67

Accessories: Closure cap: see page 110/3



2483

Amperage	Poles	110V	230V	400V	500V	>50V	>50V	Quantity	Each
		50-60 Hz	50-60 Hz	50-60 Hz	50-60 Hz	100-300Hz	301-500Hz		
		3pol 4pol 5pol	3pol 4pol 5pol	3pol 4pol 5pol	3pol 4pol 5pol	3pol 4pol 5pol	3pol 4pol 5pol		
		4h 4h 4h	6h 9h 9h	9h 6h 6h	7h 7h 7h	10h 10h 10h	2h 2h 2h		
16	3	2472	2473	2474				10	205
16	4	2475	2476	2477	2478	2479	2480	10	245
16	5	2481	2482	2483	24114			10	265
32	3	24154	24020					10	310
32	4		24101	24021	24022			10	325
32	5			2402	24079			10	340

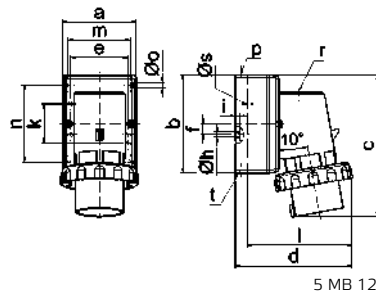

Amperage	Poles	16	16	16	32	32	32
		3	4	5	3	4	5
a		64,0	75,0	84,0	90,0	90,0	90,0
b		87,0	100,0	84,0	75,0	75,0	75,0
c		137,0	151,0	136,0	138,0	138,0	139,0
d		112,0	119,0	-	122,0	122,0	123,0
e		51,0	59,0	-	-	-	-
f		-	11,0	-	-	-	-
ø h		4,1	5,1	-	-	-	-
i		4,5	4,5	-	-	-	-
k		40,0	-	-	-	-	-
l		-	-	111,0	-	-	-
m		-	-	64,0	78,0	78,0	78,0
n		-	-	64,0	45,0	45,0	45,0
ø o		-	-	5,5	5,5	5,5	5,5
p		M20	M20	-	-	-	-
r		-	-	M20	M25	M25	M25
ø s		-	-	23,0	29,0	29,0	29,0
t		for M20	for M20	-	-	-	-

Surface Mounting Appliance Inlet

- Screw terminals
- With closure cap
- Nickel plated contacts
- Terminal for 1 mm² to 2.5 mm² conductor for 16A
- Terminal for 2.5 mm² to 6 mm² conductor for 32A
- Protection degree IP67



2495

Amperage	Poles	110V	230V	400V	500V	>50V	>50V	Quantity	Each
		50-60 Hz	50-60 Hz	50-60 Hz	50-60 Hz	100-300Hz	301-500Hz		
		3pol 4pol 5pol	3pol 4pol 5pol	3pol 4pol 5pol	3pol 4pol 5pol	3pol 4pol 5pol	3pol 4pol 5pol		
		4h 4h 4h	6h 9h 9h	9h 6h 6h	7h 7h 7h	10h 10h 10h	2h 2h 2h		
16	3	2484	2485	2486				10	245
16	4	2487	2488	2489	2490	2491	2492	10	350
16	5	2493	2494	2495				10	315
32	3	24216	24023					10	370
32	4			24024	24025			10	395
32	5			24013	24089	24078		10	410

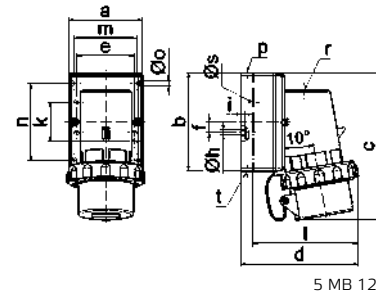

Amperage	Poles	16	16	16	32	32	32
		3	4	5	3	4	5
a		64,0	75,0	84,0	90,0	90,0	90,0
b		87,0	100,0	84,0	75,0	75,0	75,0
c		137,0	151,0	137,0	147,0	147,0	148,0
d		112,0	119,0	-	122,0	122,0	123,0
e		51,0	59,0	-	-	-	-
f		-	11,0	-	-	-	-
ø h		4,1	5,1	-	-	-	-
i		4,5	4,5	-	-	-	-
k		40,0	-	-	-	-	-
l		-	-	111,0	-	-	-
m		-	-	64,0	78,0	78,0	78,0
n		-	-	64,0	45,0	45,0	45,0
ø o		-	-	5,5	5,5	5,5	5,5
p		M20	M20	-	-	-	-
r		-	-	M20	M25	M25	M25
ø s		-	-	23,0	29,0	29,0	29,0
t		for M20	for M20	-	-	-	-

Surface Mounting Appliance Inlet QUICK-CONNECT TE

- Screwless terminal
- Nickel plated contacts
- Terminal for 1 mm² to 2.5 mm² conductor for 16A
- Terminal for 2.5 mm² to 6 mm² conductor for 32A
- Protection degree IP67

Accessories: Closure cap: see page 110/3

QUICK CONNECT



24418

Amperage	Poles	110V	230V	400V	500V	>50V	>50V	Quantity	Each
		50-60 Hz	50-60 Hz	50-60 Hz	50-60 Hz	100-300Hz	301-500Hz		
		3pol 4pol 5pol	3pol 4pol 5pol	3pol 4pol 5pol	3pol 4pol 5pol	3pol 4pol 5pol	3pol 4pol 5pol		
		4h 4h 4h	6h 9h 9h	9h 6h 6h	7h 7h 7h	10h 10h 10h	2h 2h 2h		
16	5			24416				10	275
32	5			24418				10	355

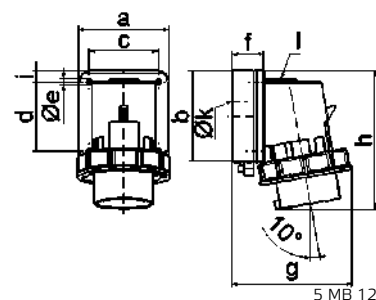

Amperage	Poles	16	32
		5	5
a		84,0	90,0
b		84,0	75,0
c		64,0	78,0
d		64,0	45,0
ø e		5,5	5,5
f		28,0	28,0
g		111,0	123,0
h		136,0	139,0
i		10,0	13,0
ø k		23,0	29,0
l		M20	M25

Surface Mounting Appliance Inlet QUICK-CONNECT TE

- Screwless terminal
- With closure cap
- Nickel plated contacts
- Terminal for 1 mm² to 2.5 mm² conductor for 16A
- Terminal for 2.5 mm² to 6 mm² conductor for 32A
- Protection degree IP67

QUICK CONNECT



24419

		110V 50-60 Hz	230V 50-60 Hz	400V 50-60 Hz	500V 50-60 Hz	>50V 100-300Hz	>50V 301-500Hz	Quantity	Each
Ampere	Poles	3pol 4pol 5pol 4h 4h 4h	3pol 4pol 5pol 6h 9h 9h	3pol 4pol 5pol 9h 6h 6h	3pol 4pol 5pol 7h 7h 7h	3pol 4pol 5pol 10h 10h 10h	3pol 4pol 5pol 2h 2h 2h		
16	5			24258				10	340
32	5			24419				10	430

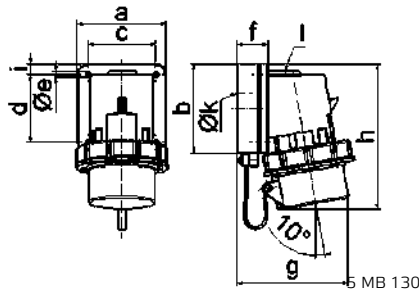

Ampere Poles	16 5	32 5
a	84,0	90,0
b	84,0	75,0
c	64,0	78,0
d	64,0	45,0
ø e	5,5	5,5
f	28,0	28,0
g	111,0	123,0
h	137,0	148,0
i	10,0	13,0
ø k	23,0	29,0
l	M20	M25

Surface Mounting Appliance Inlet

- Screw terminals
- Box terminals
- Cable entry 1x at top (open), 2x at bottom (closed)
- Base rotatable by 180°
- Nickel plated contacts
- Protection degree IP67

Accessories: closure cap, see page 110/3



24062

		110V 50-60 Hz	230V 50-60 Hz	400V 50-60 Hz	500V 50-60 Hz	>50V 100-300Hz	>50V 301-500Hz	Quantity	Each
Ampere	Poles	3pol 4pol 5pol 4h 4h 4h	3pol 4pol 5pol 6h 9h 9h	3pol 4pol 5pol 9h 6h 6h	3pol 4pol 5pol 7h 7h 7h	3pol 4pol 5pol 10h 10h 10h	3pol 4pol 5pol 2h 2h 2h		
63	3	24140	24340	24145				5	845
63	4	24232	24341	24035	24342			5	990
63	5			24062		24320		5	1040

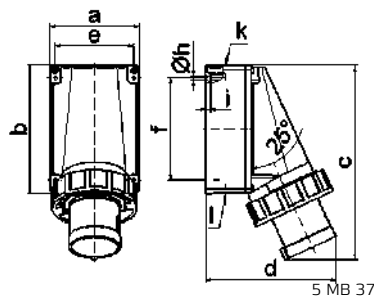

Ampere Poles	63 3	63 4	63 5
a	118,0	118,0	118,0
b	170,0	170,0	170,0
c	259,0	259,0	259,0
d	174,0	174,0	174,0
e	104,0	104,0	104,0
f	136,0	136,0	136,0
ø h	6,1	6,1	6,1
i	6,0	6,0	6,0
k	M40	M40	M40
l	M32/32	M32/32	M32/32
Cond. mm ² min	6	6	6
Cond. mm ² max	16	16	16

Surface Mounting Appliance Inlet

- Screw terminals
- Box terminals
- High-temperature-resistant contact carrier
- Nickel plated contacts
- Protection degree IP67

Accessories: closure cap, see page 110/3



24202

		110V 50-60 Hz	230V 50-60 Hz	400V 50-60 Hz	500V 50-60 Hz	>50V 100-300Hz	>50V 301-500Hz	Quantity	Each
Ampere	Poles	3pol 4pol 5pol 4h 4h 4h	3pol 4pol 5pol 6h 9h 9h	3pol 4pol 5pol 9h 6h 6h	3pol 4pol 5pol 7h 7h 7h	3pol 4pol 5pol 10h 10h 10h	3pol 4pol 5pol 2h 2h 2h		
125	3	24197	24198	24220				1	1835
125	4	24221	24199	24200	24201			1	2140
125	5	24222		24202			24279	1	2245

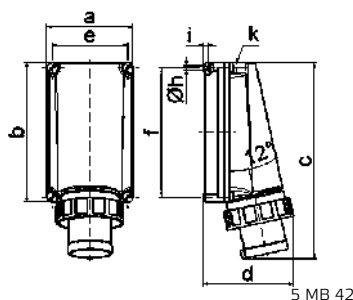

Ampere Poles	125 3	125 4	125 5
a	160,0	160,0	160,0
b	260,0	260,0	260,0
c	364,0	364,0	364,0
d	165,0	165,0	165,0
e	140,0	140,0	140,0
f	240,0	240,0	240,0
ø h	8,3	8,3	8,3
i	10,0	10,0	10,0
k	M50	M50	M50
Cond. mm ² min	16	16	16
Cond. mm ² max	50	50	50

**Panel Mounting Appliance Inlet
QUICK-CONNECT TE**

- Screwless terminals
- High-temperature-resistant contact carrier
- Nickel plated contacts
- Protection degree IP44



110V
50-60 Hz

230V
50-60 Hz

400V
50-60 Hz

500V
50-60 Hz

>50V
100-300Hz

>50V
301-500Hz



9

Ampere	Poles	110V 50-60 Hz	230V 50-60 Hz	400V 50-60 Hz	500V 50-60 Hz	>50V 100-300Hz	>50V 301-500Hz	Quantity	Each
16	5	3pol 4pol 5pol 4h 4h 4h	3pol 4pol 5pol 6h 9h 9h	3pol 4pol 5pol 9h 6h 6h	3pol 4pol 5pol 7h 7h 7h	3pol 4pol 5pol 10h 10h 10h	3pol 4pol 5pol 2h 2h 2h	10	180
32	5							10	265

QUICK CONNECT



26050

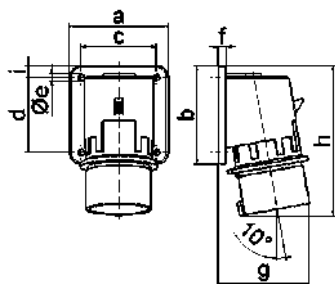

5 MB 92

Ampere	16	32
Poles	5	5
a	84,0	90,0
b	84,0	75,0
c	64,0	78,0
d	64,0	45,0
ø e	5,5	5,5
f	7,0	7,0
g	78,0	88,0
h	129,0	139,0
i	10,0	13,0
ø k	23,0	29,0
l	M20	M25
Cond. mm² min	1	2,5
Cond. mm² max	2,5	6

**Panel Mounting Appliance Inlet
QUICK-CONNECT TE**

- Screwless terminals
- With hinged lid
- High-temperature-resistant contact carrier
- Nickel plated contacts
- Protection degree IP44



110V
50-60 Hz

230V
50-60 Hz

400V
50-60 Hz

500V
50-60 Hz

>50V
100-300Hz

>50V
301-500Hz



9

Ampere	Poles	110V 50-60 Hz	230V 50-60 Hz	400V 50-60 Hz	500V 50-60 Hz	>50V 100-300Hz	>50V 301-500Hz	Quantity	Each
16	5	3pol 4pol 5pol 4h 4h 4h	3pol 4pol 5pol 6h 9h 9h	3pol 4pol 5pol 9h 6h 6h	3pol 4pol 5pol 7h 7h 7h	3pol 4pol 5pol 10h 10h 10h	3pol 4pol 5pol 2h 2h 2h	10	275
32	5							10	355

QUICK CONNECT



26052

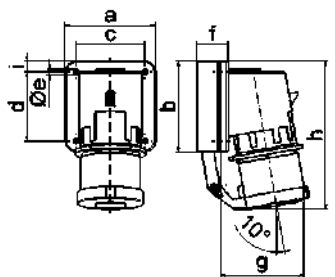

5 MB 93

Ampere	16	32
Poles	5	5
a	84,0	90,0
b	84,0	75,0
c	64,0	78,0
d	64,0	45,0
ø e	5,5	5,5
f	29,0	29,0
g	105,0	115,0
h	138,0	150,0
i	10,0	13,0
Cond. mm² min	1	2,5
Cond. mm² max	2,5	6

Panel Mounting Appliance Inlet QUICK-CONNECT TE

- Screwless terminals
- High-temperature-resistant contact carrier
- Nickel plated contacts
- Protection degree IP67

Accessories: Closure cap page 110/3

QUICK CONNECT



26054

20A-E		30A-E		34N+E		110V 50-60 Hz			230V 50-60 Hz			400V 50-60 Hz			500V 50-60 Hz			>50V 100-300Hz			>50V 301-500Hz			Quantity	Each
Ampere	Poles	3pol	4pol	5pol	3pol	4pol	5pol	3pol	4pol	5pol	3pol	4pol	5pol	3pol	4pol	5pol	3pol	4pol	5pol	2h	2h	2h			
16	5																						10	210	
32	5																						10	300	

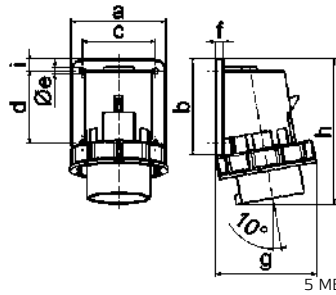

Ampere	16	32
Poles	5	5
a	84,0	90,0
b	84,0	75,0
c	64,0	78,0
d	64,0	45,0
ø e	5,5	5,5
f	7,0	7,0
g	90,0	101,0
h	129,0	139,0
i	10,0	13,0
Cond. mm² min	1	2,5
Cond. mm² max	2,5	6

5 MB 88

Panel Mounting Appliance Inlet QUICK-CONNECT TE

- Screwless terminals
- With closure cap
- High-temperature-resistant contact carrier
- Nickel plated contacts
- Protection degree IP67

QUICK CONNECT



26056

20A-E		30A-E		34N+E		110V 50-60 Hz			230V 50-60 Hz			400V 50-60 Hz			500V 50-60 Hz			>50V 100-300Hz			>50V 301-500Hz			Quantity	Each
Ampere	Poles	3pol	4pol	5pol	3pol	4pol	5pol	3pol	4pol	5pol	3pol	4pol	5pol	3pol	4pol	5pol	3pol	4pol	5pol	2h	2h	2h			
16	5																						10	335	
32	5																						10	425	

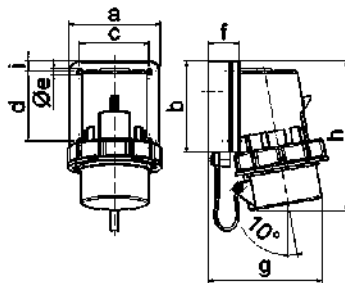

Ampere	16	32
Poles	5	5
a	84,0	90,0
b	84,0	75,0
c	64,0	78,0
d	64,0	45,0
ø e	5,5	5,5
f	28,0	28,0
g	111,0	123,0
h	137,0	148,0
i	10,0	13,0
Cond. mm² min	1	2,5
Cond. mm² max	2,5	6

5 MB 89

Panel Mounting Appliance Inlet

- Screw terminals
- Protection degree IP44



110V 50-60 Hz	230V 50-60 Hz	400V 50-60 Hz	500V 50-60 Hz	>50V 100-300Hz	>50V 301-500Hz
3pol 4pol 5pol 4h 4h 4h	3pol 4pol 5pol 6h 9h 9h	3pol 4pol 5pol 9h 6h 6h	3pol 4pol 5pol 7h 7h 7h	3pol 4pol 5pol 10h 10h 10h	3pol 4pol 5pol 2h 2h 2h

Quantity	9
Each	

Ampere	Poles	110V	230V	400V	500V	>50V	>50V	Quantity	Each
16	3	260	261	262				10	140
16	4	263	264	265	266	267	268	10	180
16	5	2610	2611	2612	2649		26036	10	180
32	3		2662					10	200
32	4	26026	2684	2663	2664	2679	26028	10	225
32	5	26023	26030	2600	26065		26029	10	230



2612

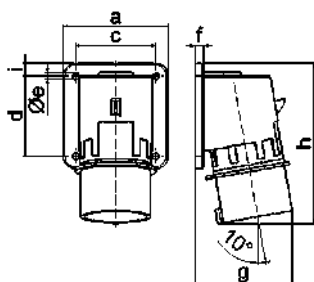

Ampere	Poles	16	16	16	32	32	32
a	3	74,0	75,0	84,0	90,0	90,0	90,0
b	4	84,0	100,0	84,0	75,0	75,0	75,0
c	5	58,0	62,0	64,0	78,0	78,0	78,0
d		64,0	74,0	64,0	45,0	45,0	45,0
ø e		5,5	4,3	5,5	5,5	5,5	5,5
f		12,0	12,0	7,0	7,0	7,0	7,0
g		70,0	77,0	78,0	86,0	86,0	88,0
h		128,0	145,0	129,0	138,0	138,0	140,0
i		-	-	-	13,0	13,0	13,0
Cond. mm² min		1	1	1	2,5	2,5	2,5
Cond. mm² max		2,5	2,5	2,5	6	6	6

5 MB 24

Panel Mounting Appliance Inlet

- Screw terminals
- With hinged lid
- Protection degree IP44



110V 50-60 Hz	230V 50-60 Hz	400V 50-60 Hz	500V 50-60 Hz	>50V 100-300Hz	>50V 301-500Hz
3pol 4pol 5pol 4h 4h 4h	3pol 4pol 5pol 6h 9h 9h	3pol 4pol 5pol 9h 6h 6h	3pol 4pol 5pol 7h 7h 7h	3pol 4pol 5pol 10h 10h 10h	3pol 4pol 5pol 2h 2h 2h

Quantity	9
Each	

Ampere	Poles	110V	230V	400V	500V	>50V	>50V	Quantity	Each
16	3	2625	2626	2627				10	165
16	4	2628	2629	2630	2631	2632	2633	10	200
16	5	2634	2635	2636	2671			10	265
32	3		2656					10	300
32	4		2685	2657	2658			10	315
32	5	26015		2655				10	340



2655

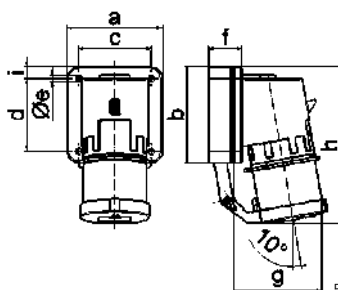

Ampere	Poles	16	16	16	32	32	32
a	3	74,0	75,0	84,0	90,0	90,0	90,0
b	4	84,0	100,0	84,0	75,0	75,0	75,0
c	5	58,0	62,0	64,0	78,0	78,0	78,0
d		64,0	74,0	64,0	45,0	45,0	45,0
ø e		5,5	4,3	5,5	5,5	5,5	5,5
f		12,0	12,0	29,0	29,0	29,0	29,0
g		78,0	88,0	105,0	114,0	114,0	115,0
h		134,0	151,0	138,0	149,0	149,0	150,0
i		-	-	-	13,0	13,0	13,0
Cond. mm² min		1	1	1	2,5	2,5	2,5
Cond. mm² max		2,5	2,5	2,5	6	6	6

5 MB 2

Panel Mounting Appliance Inlet

- Screw terminals
- Nickel plated contacts
- Protection degree IP67

Accessories: Closure cap: see page 110/3



2601

Ampere	Poles	110V 50-60 Hz			230V 50-60 Hz			400V 50-60 Hz			500V 50-60 Hz			>50V 100-300Hz			>50V 301-500Hz			Quantity	Each
		3pol	4pol	5pol	3pol	4pol	5pol	3pol	4pol	5pol	3pol	4pol	5pol	3pol	4pol	5pol	3pol	4pol	5pol		
16	3			2613			2614			2615									10	160	
16	4			2616			2617			2618			2619	2620		2621			10	180	
16	5			2622			2623			2624			2650						10	205	
32	3			26033			2665												10	250	
32	4						2694			2666			2667						10	265	
32	5									2601									10	280	

Ampere	Poles	16	16	16	32	32	32
a	74,0	75,0	84,0	90,0	90,0	90,0	90,0
b	84,0	100,0	84,0	75,0	75,0	75,0	75,0
c	58,0	62,0	64,0	78,0	78,0	78,0	78,0
d	64,0	74,0	64,0	45,0	45,0	45,0	45,0
ø e	5,5	4,3	5,5	5,5	5,5	5,5	5,5
f	12,0	12,0	7,0	7,0	7,0	7,0	7,0
g	80,0	88,0	90,0	100,0	100,0	101,0	101,0
h	128,0	145,0	129,0	138,0	138,0	139,0	139,0
i	-	-	10,0	13,0	13,0	13,0	13,0
Cond. mm² min	1	1	1	2,5	2,5	2,5	2,5
Cond. mm² max	2,5	2,5	2,5	6	6	6	6

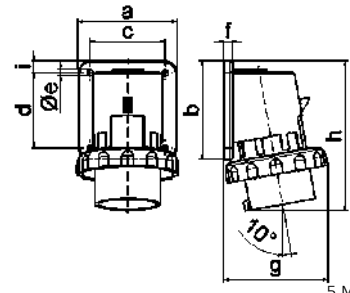

5 MB 1

Panel Mounting Appliance Inlet

- Screw terminals
- With closure cap
- Nickel plated contacts
- Protection degree IP67



2604

Ampere	Poles	110V 50-60 Hz			230V 50-60 Hz			400V 50-60 Hz			500V 50-60 Hz			>50V 100-300Hz			>50V 301-500Hz			Quantity	Each
		3pol	4pol	5pol	3pol	4pol	5pol	3pol	4pol	5pol	3pol	4pol	5pol	3pol	4pol	5pol					
16	3			2637			2638			2639									10	200	
16	4			2640			2641			2642			2643	2644		2645			10	280	
16	5			2646			2647			2648									10	310	
32	3						2659												10	370	
32	4									2660			2661						10	390	
32	5									2604									10	405	

Ampere	Poles	16	16	16	32	32	32
a	74,0	75,0	84,0	90,0	90,0	90,0	90,0
b	84,0	100,0	84,0	75,0	75,0	75,0	75,0
c	58,0	62,0	64,0	78,0	78,0	78,0	78,0
d	64,0	74,0	64,0	45,0	45,0	45,0	45,0
ø e	5,5	4,3	5,5	5,5	5,5	5,5	5,5
f	12,0	12,0	29,0	29,0	29,0	29,0	29,0
g	80,0	88,0	111,0	123,0	123,0	123,0	123,0
h	133,0	152,0	134,0	147,0	147,0	148,0	148,0
i	-	-	10,0	13,0	13,0	13,0	13,0
Cond. mm² min	1	1	1	2,5	2,5	2,5	2,5
Cond. mm² max	2,5	2,5	2,5	6	6	6	6

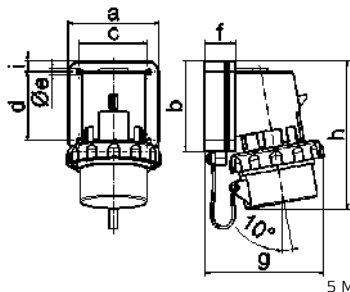

5 MB 3

Appliance Inlet with Flange QUICK-CONNECT TE

- Screwless terminals
- 10° angled
- High-temperature-resistant contact carrier
- Nickel plated contacts
- Protection degree IP44

 QUICK CONNECT



27124

Ampere	Poles	110V 50-60 Hz	230V 50-60 Hz	400V 50-60 Hz	500V 50-60 Hz	>50V 100-300Hz	>50V 301-500Hz	Quantity	Each
		3pol 4pol 5pol 4h 4h 4h	3pol 4pol 5pol 6h 9h 9h	3pol 4pol 5pol 9h 6h 6h	3pol 4pol 5pol 7h 7h 7h	3pol 4pol 5pol 10h 10h 10h	3pol 4pol 5pol 2h 2h 2h		
16	3	27209	27121	27210				10	140
16	4	27211	27207	27122				10	215
16	5	27215	27216	27124				10	240
32	3	27218	27219	27220				10	275
32	4	27221	27222	27223				10	250
32	5	27247	27248	27249				10	315

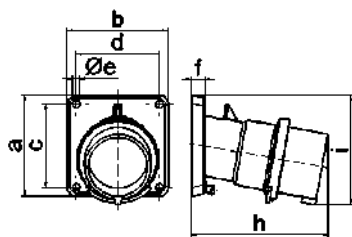

Ampere	16	16	16	32	32	32
Poles	3	4	5	3	4	5
a	85,0	85,0	85,0	85,0	85,0	85,0
b	85,0	85,0	85,0	85,0	85,0	85,0
c	70,0	70,0	70,0	70,0	70,0	70,0
d	70,0	70,0	70,0	70,0	70,0	70,0
ø e	6,3	6,3	6,3	6,3	6,3	6,3
f	11,0	11,0	11,0	11,0	11,0	11,0
h	104,0	110,0	116,0	121,0	121,0	127,0
i	83,0	90,0	92,0	96,0	96,0	100,0
Cond. mm² min	1	1	1	2,5	2,5	2,5
Cond. mm² max	2,5	2,5	2,5	6	6	6

5 MB 21

Appliance Inlet with Flange TE

- Screw terminals
- 10° angled
- Box terminals
- High-temperature-resistant contact carrier
- Nickel plated contacts
- Protection degree IP44



2781

Ampere	Poles	110V 50-60 Hz	230V 50-60 Hz	400V 50-60 Hz	500V 50-60 Hz	>50V 100-300Hz	>50V 301-500Hz	Quantity	Each
		3pol 4pol 5pol 4h 4h 4h	3pol 4pol 5pol 6h 9h 9h	3pol 4pol 5pol 9h 6h 6h	3pol 4pol 5pol 7h 7h 7h	3pol 4pol 5pol 10h 10h 10h	3pol 4pol 5pol 2h 2h 2h		
63	3	2770	2771	2772				5	550
63	4	2773	2774	2775				5	570
63	5	2779	2780	2781				5	625

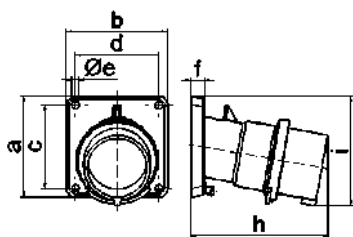

Ampere	63	63	63
Poles	3	4	5
a	107,0	107,0	107,0
b	100,0	100,0	100,0
c	85,0	85,0	85,0
d	77,0	77,0	77,0
ø e	6,5	6,5	6,5
f	12,0	12,0	12,0
h	155,0	155,0	155,0
i	118,0	118,0	118,0
Cond. mm² min	6	6	6
Cond. mm² max	16	16	16

5 MB 21

Appliance Inlet with Flange QUICK-CONNECT TE

- Screwless terminals
- 10° angled
- High-temperature-resistant contact carrier
- Nickel plated contacts
- Protection degree IP67

Accessories: closure cap, see page 110/3

QUICK CONNECT



2793

Ampere	Poles	110V	230V	400V	500V	>50V	>50V	Quantity	Each
		50-60 Hz	50-60 Hz	50-60 Hz	50-60 Hz	100-300Hz	301-500Hz		
16	3	27227	2783	27228				10	175
16	4	27229	2786	2787				10	220
16	5	27233	27234	2793				10	245
32	3	27235	27236	27237				10	275
32	4	27238	27239	27240				10	295
32	5	27244	27245	27246				10	335

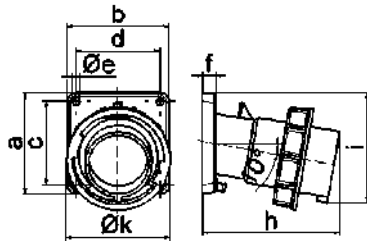

Ampere	16	16	16	32	32	32
Poles	3	4	5	3	4	5
a	85,0	85,0	85,0	85,0	85,0	85,0
b	85,0	85,0	85,0	85,0	85,0	85,0
c	70,0	70,0	70,0	70,0	70,0	70,0
d	70,0	70,0	70,0	70,0	70,0	70,0
ø e	6,3	6,3	6,3	6,3	6,3	6,3
f	11,0	11,0	11,0	11,0	11,0	11,0
h	104,0	110,0	116,0	121,0	121,0	127,0
i	83,0	90,0	92,0	96,0	96,0	100,0
k	70,5	79,5	86,5	95,0	95,0	101,5
Cond. mm² min	1	1	1	2,5	2,5	2,5
Cond. mm² max	2,5	2,5	2,5	6	6	6

5 MB 22

Appliance Inlet with Flange TE

- Screw terminals
- 10° angled
- Box terminals
- High-temperature-resistant contact carrier
- Nickel plated contacts
- Protection degree IP67

Accessories: closure cap, see page 110/3



270

Ampere	Poles	110V	230V	400V	500V	>50V	>50V	Quantity	Each
		50-60 Hz	50-60 Hz	50-60 Hz	50-60 Hz	100-300Hz	301-500Hz		
63	3	27006	27007	27008				5	575
63	4	27009	27010	27011				5	640
63	5	27015	27016	27017				5	695

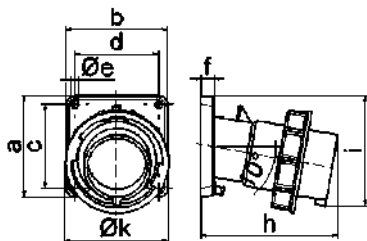

Ampere	63	63	63
Poles	3	4	5
a	107,0	107,0	107,0
b	100,0	100,0	100,0
c	85,0	85,0	85,0
d	77,0	77,0	77,0
ø e	6,5	6,5	6,5
f	12,0	12,0	12,0
h	155,0	155,0	155,0
i	118,0	118,0	118,0
k	113,5	113,5	113,5
Cond. mm² min	6	6	6
Cond. mm² max	16	16	16

5 MB 22

Appliance Inlet with Flange TE

- Screw terminals
- 10° angled
- Box terminals
- High-temperature-resistant contact carrier
- Nickel plated contacts
- Protection degree IP67

Accessories: closure cap, see page 110/3



2744

Ampere	Poles	110V	230V	400V	500V	>50V	>50V	Quantity	Each
		50-60 Hz	50-60 Hz	50-60 Hz	50-60 Hz	100-300Hz	301-500Hz		
125	3	2735	2736	2737				5	905
125	4	2738	2739	2740				5	1020
125	5	2742	2743	2744				5	1115

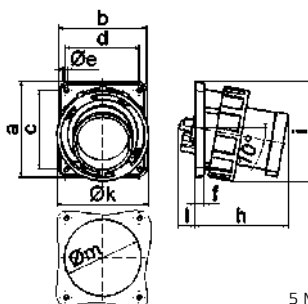

Ampere	125	125	125
Poles	3	4	5
a	130,0	130,0	130,0
b	120,0	120,0	120,0
c	108,0	108,0	108,0
d	100,0	100,0	100,0
ø e	6,5	6,5	6,5
f	13,0	13,0	13,0
h	130,0	130,0	130,0
i	135,0	135,0	135,0
k	126,0	126,0	126,0
l	23,0	23,0	23,0
ø m	105,0	105,0	105,0
Cond. mm² min	16	16	16
Cond. mm² max	50	50	50

5 MB 56

Appliance Inlet with Flange QUICK-CONNECT

- Screwless terminals
- Flange 75 x 75 mm
- Protection degree IP44

A retaining device to match the hinged cover of the connector must be provided to ensure the latching feature

QUICK CONNECT



282002

Amperage	Poles	110V 50-60 Hz	230V 50-60 Hz	400V 50-60 Hz	500V 50-60 Hz	>50V 100-300Hz	>50V 301-500Hz	Quantity	Each
		3pol 4pol 5pol 4h 4h 4h	3pol 4pol 5pol 6h 9h 9h	3pol 4pol 5pol 9h 6h 6h	3pol 4pol 5pol 7h 7h 7h	3pol 4pol 5pol 10h 10h 10h	3pol 4pol 5pol 2h 2h 2h		
16	3	28001	28111				28002	10	90
16	4	28003	28017	28112	28004		28005	10	105
16	5		28006	282001			28008	10	125
32	3	28009	28010					10	145
32	4		28011	28012	28013			10	165
32	5	28014	28015	282002				10	195

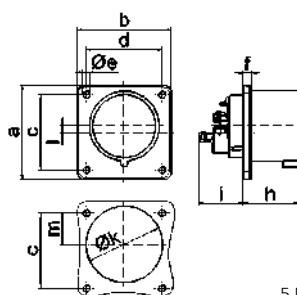

Amperage Poles	16 3	16 4	16 5	32 3	32 4	32 5
a	75,0	75,0	75,0	75,0	75,0	75,0
b	75,0	75,0	75,0	75,0	75,0	75,0
c	60,0	60,0	60,0	60,0	60,0	60,0
d	60,0	60,0	60,0	60,0	60,0	60,0
ø e	5,5	5,5	5,5	5,5	5,5	5,5
f	7,0	7,0	7,0	7,0	7,0	7,0
h	43,0	43,0	43,0	53,0	53,0	53,0
i	39,0	39,0	39,0	43,0	43,0	43,0
ø k	42,0	48,0	61,0	57,0	57,0	60,0
l	-	-	5,0	2,0	2,0	-
m	30,0	30,0	25,0	28,0	28,0	30,0
Cond. mm² min	1	1	1	2,5	2,5	2,5
Cond. mm² max	2,5	2,5	2,5	6	6	6

5 MB 85

Appliance Inlet with Flange

- Screw terminals
- Protection degree IP44

A retaining device to match the hinged cover of the connector must be provided to ensure the latching feature



28108

Amperage	Poles	110V 50-60 Hz	230V 50-60 Hz	400V 50-60 Hz	500V 50-60 Hz	>50V 100-300Hz	>50V 301-500Hz	Quantity	Each
		3pol 4pol 5pol 4h 4h 4h	3pol 4pol 5pol 6h 9h 9h	3pol 4pol 5pol 9h 6h 6h	3pol 4pol 5pol 7h 7h 7h	3pol 4pol 5pol 10h 10h 10h	3pol 4pol 5pol 2h 2h 2h		
16	3		2898					10	155
16	4			28100				10	170
16	5			28102				10	185
32	3		28104					10	
32	4			28106				10	
32	5			28108				10	240

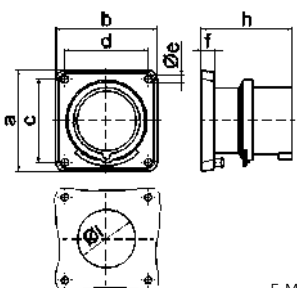

Amperage Poles	16 3	16 4	16 5	32 3	32 4	32 5
a	85,0	85,0	85,0	85,0	85,0	85,0
b	85,0	85,0	85,0	85,0	85,0	85,0
c	70,0	70,0	70,0	70,0	70,0	70,0
d	70,0	70,0	70,0	70,0	70,0	70,0
ø e	6,3	6,3	6,3	6,3	6,3	6,3
f	11,0	11,0	11,0	11,0	11,0	11,0
h	75,5	75,0	76,5	85,0	85,0	85,0
ø l	49,0	49,0	49,0	49,0	49,0	49,0
Cond. mm² min	1	1	1	2,5	2,5	2,5
Cond. mm² max	2,5	2,5	2,5	6	6	6

5 MB 126

Appliance Inlet with Flange

- Screw terminals
- Box terminals
- High-temperature-resistant contact carrier
- Nickel plated contacts
- Protection degree IP44

A retaining device to match the hinged cover of the connector must be provided to ensure the latching feature



2837

Amperage	Poles	110V 50-60 Hz	230V 50-60 Hz	400V 50-60 Hz	500V 50-60 Hz	>50V 100-300Hz	>50V 301-500Hz	Quantity	Each
		3pol 4pol 5pol 4h 4h 4h	3pol 4pol 5pol 6h 9h 9h	3pol 4pol 5pol 9h 6h 6h	3pol 4pol 5pol 7h 7h 7h	3pol 4pol 5pol 10h 10h 10h	3pol 4pol 5pol 2h 2h 2h		
63	3	2880	2834			2869		5	465
63	4		2841	2833	2864			5	530
63	5			2837	2858			5	580

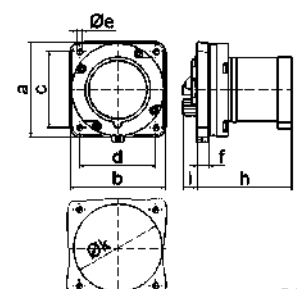

Amperage Poles	63 3	63 4	63 5
a	110,0	110,0	110,0
b	106,0	106,0	106,0
c	90,0	90,0	90,0
d	90,0	90,0	90,0
ø e	5,5	5,5	5,5
f	13,0	13,0	13,0
h	99,0	99,0	99,0
i	19,0	19,0	19,0
k	93,0	93,0	93,0
Cond. mm² min	6	6	6
Cond. mm² max	16	16	16

5 MB 59

Appliance Inlet with Flange

- Screw terminals
- High-temperature-resistant contact carrier
- Nickel plated contacts
- Protection degree IP67

A retaining device to match the hinged cover of the connector must be provided to ensure the latching feature

Accessories: closure cap, see page 110/3



28109

Ampere	Poles	110V 50-60 Hz	230V 50-60 Hz	400V 50-60 Hz	500V 50-60 Hz	>50V 100-300Hz	>50V 301-500Hz	Quantity	Each
		3pol 4pol 5pol 4h 4h 4h	3pol 4pol 5pol 6h 9h 9h	3pol 4pol 5pol 9h 6h 6h	3pol 4pol 5pol 7h 7h 7h	3pol 4pol 5pol 10h 10h 10h	3pol 4pol 5pol 2h 2h 2h		
16	3	2899						10	180
16	4			28101				10	200
16	5			28103				10	220
32	3	28105						10	250
32	4			28107				10	270
32	5			28109				10	300

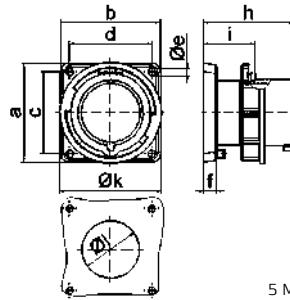

Ampere Poles	16 3	16 4	16 5	32 3	32 4	32 5
a	85,0	85,0	85,0	85,0	85,0	85,0
b	85,0	85,0	85,0	85,0	85,0	85,0
c	70,0	70,0	70,0	70,0	70,0	70,0
d	70,0	70,0	70,0	70,0	70,0	70,0
ø e	6,3	6,3	6,3	6,3	6,3	6,3
f	11,0	11,0	11,0	11,0	11,0	11,0
h	75,5	75,0	76,5	85,0	85,0	85,0
i	44,0	44,0	44,0	44,0	44,0	44,0
k	70,5	78,5	86,5	94,0	94,0	101,5
ø l	49,0	49,0	49,0	49,0	49,0	49,0
Cond. mm² min	1	1	1	2,5	2,5	2,5
Cond. mm² max	2,5	2,5	2,5	6	6	6

5 MB 124

Appliance Inlet with Flange TE

- Screw terminals
- Box terminals
- High-temperature-resistant contact carrier
- Nickel plated contacts
- Protection degree IP67

A retaining device to match the hinged cover of the connector must be provided to ensure the latching feature

Accessories: closure cap, see page 110/3



2838

Ampere	Poles	110V 50-60 Hz	230V 50-60 Hz	400V 50-60 Hz	500V 50-60 Hz	>50V 100-300Hz	>50V 301-500Hz	Quantity	Each
		3pol 4pol 5pol 4h 4h 4h	3pol 4pol 5pol 6h 9h 9h	3pol 4pol 5pol 9h 6h 6h	3pol 4pol 5pol 7h 7h 7h	3pol 4pol 5pol 10h 10h 10h	3pol 4pol 5pol 2h 2h 2h		
63	3	2881	2835					5	530
63	4			2842	2836			5	580
63	5			2838				5	650

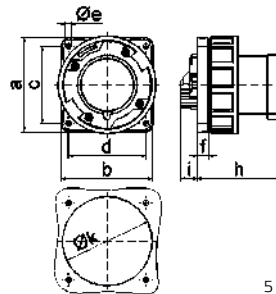

Ampere Poles	63 3	63 4	63 5
a	110,0	110,0	110,0
b	106,0	106,0	106,0
c	90,0	90,0	90,0
d	90,0	90,0	90,0
ø e	5,5	5,5	5,5
f	13,0	13,0	13,0
h	99,0	99,0	99,0
i	19,0	19,0	19,0
k	93,0	93,0	93,0
Cond. mm² min	6	6	6
Cond. mm² max	16	16	16

5 MB 50

Appliance Inlet with Flange TE

- Screw terminals
- Flange 120 x 120 mm
- Box terminals
- High-temperature-resistant contact carrier
- Nickel plated contacts
- Protection degree IP67

A retaining device to match the hinged cover of the connector must be provided to ensure the latching feature

Accessories: closure cap, see page 110/3



2876

Ampere	Poles	110V 50-60 Hz	230V 50-60 Hz	400V 50-60 Hz	500V 50-60 Hz	>50V 100-300Hz	>50V 301-500Hz	Quantity	Each
		3pol 4pol 5pol 4h 4h 4h	3pol 4pol 5pol 6h 9h 9h	3pol 4pol 5pol 9h 6h 6h	3pol 4pol 5pol 7h 7h 7h	3pol 4pol 5pol 10h 10h 10h	3pol 4pol 5pol 2h 2h 2h		
125	3	2882	2860					5	885
125	4			2861				5	950
125	5			2876				5	1110

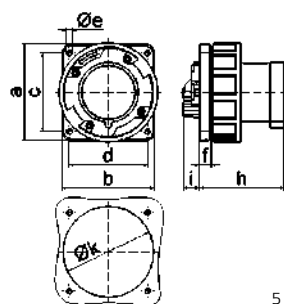

Ampere Poles	125 3	125 4	125 5
a	120,0	120,0	120,0
b	120,0	120,0	120,0
c	100,0	100,0	100,0
d	100,0	100,0	100,0
ø e	6,5	6,5	6,5
f	13,0	13,0	13,0
h	116,0	116,0	116,0
i	20,0	20,0	20,0
k	104,0	104,0	104,0
Cond. mm² min	16	16	16
Cond. mm² max	50	50	50

5 MB 57

Technical Information

- IEC 60309-1/2, EN 60309, VDE 0623
- Particularly suitable for harsh operating conditions, especially resistant to aggressive atmospheres

Appliance Inlet with Flange QUICK-CONNECT TE

- Screwless terminals
- 10° angled
- High-temperature-resistant contact carrier
- Nickel plated contacts
- Protection degree IP44

Dimension drawing: see page 99/1 (5 MB 21)

QUICK CONNECT

27249



Amperage	Poles	230V 50-60 Hz	400V 50-60 Hz	500V 50-60 Hz	Quantity	Each
		3pol 6h 4pol 9h 5pol 9h	3pol 9h 4pol 6h 5pol 6h	3pol 7h 4pol 7h 5pol 7h		
16	3	27121	27210		10	140
16	4	27207	27122	27212	10	215
16	5	27216	27124	27217	10	240
32	3	27219	27220		10	275
32	4	27222	27223	27224	10	250
32	5	27248	27249		10	315

Appliance Inlet with Flange TE

- Screw terminals
- 10° angled
- High-temperature-resistant contact carrier
- Box terminals
- Nickel plated contacts
- Protection degree IP44

Dimension drawing: see page 99/2 (5 MB 21)

2781



Amperage	Poles	230V 50-60 Hz	400V 50-60 Hz	500V 50-60 Hz	Quantity	Each
		3pol 6h 4pol 9h 5pol 9h	3pol 9h 4pol 6h 5pol 6h	3pol 7h 4pol 7h 5pol 7h		
63	3	2771	2772		5	515
63	4	2774	2775	2776	5	570
63	5	2780	2781		5	625

Appliance Inlet with Flange TE

- Screwless terminals
- 10° angled
- High-temperature-resistant contact carrier
- Nickel plated contacts
- Protection degree IP67

Accessories: closure cap, see page 110/3
Dimension drawing: see page 100/1 (5 MB 22)

QUICK CONNECT

27246



Amperage	Poles	230V 50-60 Hz	400V 50-60 Hz	500V 50-60 Hz	Quantity	Each
		3pol 6h 4pol 9h 5pol 9h	3pol 9h 4pol 6h 5pol 6h	3pol 7h 4pol 7h 5pol 7h		
16	3	2783	27228		10	175
16	4	2786	2787	27230	10	220
16	5	27234	2793	27278	10	245
32	3	27236	27237		10	275
32	4	27239	27240	27241	10	295
32	5	27245	27246		10	335

Appliance Inlet with Flange TE

- Screw terminals
- 10° angled
- High-temperature-resistant contact carrier
- Box terminals
- Nickel plated contacts
- Protection degree IP67

Accessories: closure cap, see page 110/3
Dimension drawing: see page 100/2 (5 MB 22)

27017



Amperage	Poles	230V 50-60 Hz	400V 50-60 Hz	500V 50-60 Hz	Quantity	Each
		3pol 6h 4pol 9h 5pol 9h	3pol 9h 4pol 6h 5pol 6h	3pol 7h 4pol 7h 5pol 7h		
63	3	27007	27008		5	575
63	4	27010	27011	27012	5	640
63	5	27016	27017		5	695

Appliance Inlet with Flange TE

- Screw terminals
- 10° angled
- High-temperature-resistant contact carrier
- Box terminals
- Nickel plated contacts
- Protection degree IP67

A retaining device to match the hinged cover of the connector must be provided to ensure the latching feature

Accessories: closure cap, see page 110/3
Dimension drawing: see page 100/3 (5 MB 56)

2744



Amperage	Poles	230V 50-60 Hz	400V 50-60 Hz	500V 50-60 Hz	Quantity	Each
		3pol 6h 4pol 9h 5pol 9h	3pol 9h 4pol 6h 5pol 6h	3pol 7h 4pol 7h 5pol 7h		
125	3	2736	2737		5	905
125	4	2739	2740	2741	5	1020
125	5	2743	2744	27024	5	1115

**Phase Inverter as Plug
QUICK-CONNECT with MULTI-GRIP**

- Screwless terminals
- Screwless enclosure connection, self locking
- Special gland, simultaneous cable gland and seal
- Protection degree IP44



225

QUICK CONNECT
MULTI GRIP

Amperage	Poles	230V 50-60 Hz			400V 50-60 Hz			Quantity	Each
		3pol 6h	4pol 9h	5pol 9h	3pol 9h	4pol 6h	5pol 6h		
16	4	22052			22053		10	135	
16	5	224			225		10	160	
32	4	22054			22055		10	250	
32	5				227		10	260	

**Phase Inverter as Plug TE
with MULTI-GRIP**

- Screw terminals
- Special gland, simultaneous cable gland and seal
- High-temperature-resistant contact carrier
- Nickel plated contacts
- Protection degree IP44



2271

Dimension drawing: see page 86/2 (2 MB 93)

MULTI GRIP

Amperage	Poles	230V 50-60 Hz			400V 50-60 Hz			Quantity	Each
		3pol 6h	4pol 9h	5pol 9h	3pol 9h	4pol 6h	5pol 6h		
16	5			2286			10	195	
32	5			2287			10	300	

**Phase Inverter as Plug TE
with MULTI-GRIP**

- Screw terminals
- Special gland, simultaneous cable gland and seal
- High-temperature-resistant contact carrier
- Nickel plated contacts
- Protection degree IP67



2251

Accessories: closure cap page 110/3
Dimension drawing: see page 87/1 (2 MB 94)

MULTI GRIP

Amperage	Poles	230V 50-60 Hz			400V 50-60 Hz			Quantity	Each
		3pol 6h	4pol 9h	5pol 9h	3pol 9h	4pol 6h	5pol 6h		
16	5			2266			10	230	
32	5			2267			10	360	

**Phase Inverter as
Surface Mounting Appliance Inlet**

- Screw terminals
- High-temperature-resistant contact carrier
- Nickel plated contacts
- Protection degree IP44



24211

Dimension drawing: see page 90/1 (5 MB 45)

Amperage	Poles	230V 50-60 Hz			400V 50-60 Hz			Quantity	Each
		3pol 6h	4pol 9h	5pol 9h	3pol 9h	4pol 6h	5pol 6h		
16	5			24208			10	320	
32	5			24210			10	380	

**Phase Inverter as
Panel Mounting Appliance Inlet**

- Screw terminals
- Nickel plated contacts
- Protection degree IP44



2602

Dimension drawing: see page 95/1 (5 MB 92)

Amperage	Poles	230V 50-60 Hz			400V 50-60 Hz			Quantity	Each
		3pol 6h	4pol 9h	5pol 9h	3pol 9h	4pol 6h	5pol 6h		
16	5			26008			10	185	
32	5			2652			10	250	

Phase Inverter as Panel Mounting Appliance Inlet

- Screw terminals
- With hinged lid
- Nickel plated contacts
- Protection degree IP44

Dimension drawing: see page 95/2 (5 MB 93)



26020

Amperage	Poles	230V 50-60 Hz			400V 50-60 Hz			Quantity	Each
		3pol 6h	4pol 9h	5pol 9h	3pol 9h	4pol 6h	5pol 6h		
16	5						10	270	
32	5						10	345	

Phase Inverter as Appliance Inlet with Flange

- Screw terminals
- Nickel plated contacts
- Protection degree IP44

A retaining device to match the hinged cover of the connector must be provided to ensure the latching feature

Dimension drawing: see page 101/2 (5 MB 126)



28183

Amperage	Poles	230V 50-60 Hz			400V 50-60 Hz			Quantity	Each
		3pol 6h	4pol 9h	5pol 9h	3pol 9h	4pol 6h	5pol 6h		
16	5						10	205	
32	5						10	275	

Phase Inverter as Appliance Inlet with Flange

- Screw terminals
- Nickel plated contacts
- High-temperature-resistant contact carrier
- Protection degree IP44

A retaining device to match the hinged cover of the connector must be provided to ensure the latching feature

Dimension drawing: see page 101/1 (5 MB 85)



2870

Amperage	Poles	230V 50-60 Hz			400V 50-60 Hz			Quantity	Each
		3pol 6h	4pol 9h	5pol 9h	3pol 9h	4pol 6h	5pol 6h		
16	5						10	140	
32	5						10	195	

Phase Inverter as Panel Mounting Appliance Inlet

- Screw terminals
- High-temperature-resistant contact carrier
- Nickel plated contacts
- Protection degree IP67

Accessories: closure cap, see page 110/3
Dimension drawing: see page 98/1 (5 MB 1)



2607

Amperage	Poles	230V 50-60 Hz			400V 50-60 Hz			Quantity	Each
		3pol 6h	4pol 9h	5pol 9h	3pol 9h	4pol 6h	5pol 6h		
16	5						10	205	
32	5						10	285	

Phase Inverter as Appliance Inlet with Flange

- Screw terminals
- Nickel plated contacts
- Protection degree IP67

A retaining device to match the hinged cover of the connector must be provided to ensure the latching feature

Accessories: closure cap, see page 110/3
Dimension drawing: see page 102/1 (5 MB 124)



28184

Amperage	Poles	230V 50-60 Hz			400V 50-60 Hz			Quantity	Each
		3pol 6h	4pol 9h	5pol 9h	3pol 9h	4pol 6h	5pol 6h		
16	5						10	250	
32	5						10	310	

Technical Information

- IEC 60309, EN 60309, VDE 0623
- Only suitable for short time service!

Phase Sequence Indicator

- Nickel plated contacts

Phase sequence indicators for reefer container, see page 213/1



2214

Amperes	Poles	230V 50-60 Hz	400V 50-60 Hz	500V 50-60 Hz	Quantity	Each
		3pol 6h 4pol 9h 5pol 9h	3pol 9h 4pol 6h 5pol 6h	3pol 7h 4pol 7h 5pol 7h		
16	5	2213	2214	2215	10	175
32	4	2216	2217	2218	10	245
32	5	2219	2220	2221	10	250
63	4	2222	2223	2224	2	475
63	5	2225	2226	2227	2	525

Phase Sequence Indicator "TRIPOL" 400/ 230V

- Nickel plated contacts
- With integrated Domestic socket (type F - German standard)
- Integrated electronics for:
 - rotary field indicator
 - connection of testing devices
 - phase sequence indicator



2235

Amperes	Poles	230V 50-60 Hz	400V 50-60 Hz	500V 50-60 Hz	Quantity	Each
		3pol 6h 4pol 9h 5pol 9h	3pol 9h 4pol 6h 5pol 6h	3pol 7h 4pol 7h 5pol 7h		
16	5		2234		10	240
32	5		2235		5	310
63	5		2236		2	610

Phase Sequence Indicator

- Nickel plated contacts
- Without keyway
- For all operating voltages between 230V and 600V



2231

Amperes	Poles				Quantity	Each
		3pol 9h	4pol 6h	5pol 6h		
16	5			2229	10	175
32	4			2230	10	245
32	5			2231	10	250
63	4			2232	2	475
63	5			2233	1	525

Adapter Plug

Further adapter systems on request.



8615

	Ref. no.
CEE plug 16A/ 230V/ 3p to Domestic socket 16A/ 230V~ type F - German standard	8615
CEE plug 16A/ 230V/ 3p to domestic socket 16A/ 230V ~, type E Belgian/French standard	8614
CEE plug 16A/ 230V/ 3p to domestic socket 16A/ 230V ~, type J Swiss standard	8618

Adapter Plug

Further adapter systems on request.



860

	Ref. no.
CEE plug 16A/ 400V/ 5p to Domestic socket 16A/ 230V~ type F - German standard	860

Connector INNOLINQ

- Screwless terminals
- Screwless enclosure connection, self locking
- Special gland, simultaneous cable gland and seal
- Protection degree IP54
- Contact carrier is made of high temperature resistant material
- Contains no lead

- QUICK CONNECT**
- KONTEX ULTRA**
- MULTI GRIP**



301

Ampere	Poles	110V 50-60 Hz	230V 50-60 Hz	400V 50-60 Hz	500V 50-60 Hz	>50V 100-300Hz	>50V 301-500Hz	Quantity	Each
		3pol 4pol 5pol 4h 4h 4h	3pol 4pol 5pol 6h 9h 9h	3pol 4pol 5pol 9h 6h 6h	3pol 4pol 5pol 7h 7h 7h	3pol 4pol 5pol 10h 10h 10h	3pol 4pol 5pol 2h 2h 2h		
16	3	310	311	312	31891	31892	31049	10	135
16	4	313	314	315	316	317	318	10	148
16	5	3110	3111	300	31094	319	31270	10	200
32	3	3113	3114	3115	31906	31907	31603	10	300
32	4	3116	3117	3118	3119	3120	3121	10	312
32	5	3122	3123	301	31602	31919	31604	10	330

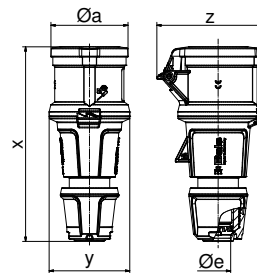

Ampere	16	16	16	32	32	32
Polzahl	3	4	5	3	4	5
ø a	55,0	61,0	68,0	69,0	69,0	76,0
x	157,0	171,0	171,0	205,0	205,0	205,0
y	59,0	71,0	71,0	80,0	80,0	80,0
z	80,0	90,0	94,0	99,0	99,0	105,0
ø e	18,0	21,0	21,0	29,0	29,0	29,0
Cond. mm² min	1	1	1	2,5	2,5	2,5
Cond. mm² max	2,5	2,5	2,5	6,0	6,0	6,0

Connector TE-Plus with MULTI-GRIP

- Screwless terminals
- High-temperature-resistant contact carrier
- Kontex contact
- Nickel plated contacts
- Special gland, simultaneous cable gland and seal
- Protection degree IP44

- QUICK CONNECT**
- MULTI GRIP**



31981

Ampere	Poles	110V 50-60 Hz	230V 50-60 Hz	400V 50-60 Hz	500V 50-60 Hz	>50V 100-300Hz	>50V 301-500Hz	Quantity	Each
		3pol 4pol 5pol 4h 4h 4h	3pol 4pol 5pol 6h 9h 9h	3pol 4pol 5pol 9h 6h 6h	3pol 4pol 5pol 7h 7h 7h	3pol 4pol 5pol 10h 10h 10h	3pol 4pol 5pol 2h 2h 2h		
16	3	31659	31533	31665	31955	31956	31957	10	145
16	4	31681	31661	31534	31959	31669	31671	10	170
16	5	31962	31662	31536	31964	31965	31966	10	200
32	3	31967	31968	31666	31970	31971	31972	10	265
32	4	31973	31974	31975	31976	31670	31672	10	285
32	5	31979	31664	31981	31884	31983	31984	10	340

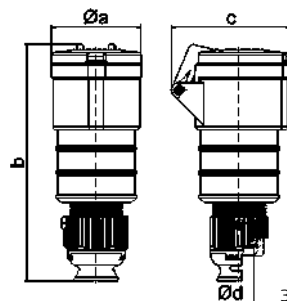

Ampere	16	16	16	32	32	32
Polzahl	3	4	5	3	4	5
ø a	51,0	58,0	65,0	66,5	66,5	72,0
b	156,0	162,0	168,0	195,0	195,0	198,0
c	72,0	78,0	86,0	89,0	89,0	99,0
ø d	18,0	18,0	21,0	23,0	23,0	27,0
Cond. mm² min	1	1	1	2,5	2,5	2,5
Cond. mm² max	2,5	2,5	2,5	6	6	6

Connector TE with MULTI-GRIP

- High-temperature-resistant contact carrier
- Kontex contact
- Nickel plated contacts
- Special gland, simultaneous cable gland and seal
- Protection degree IP44

- MULTI GRIP**



3112

Ampere	Poles	110V 50-60 Hz	230V 50-60 Hz	400V 50-60 Hz	500V 50-60 Hz	>50V 100-300Hz	>50V 301-500Hz	Quantity	Each
		3pol 4pol 5pol 4h 4h 4h	3pol 4pol 5pol 6h 9h 9h	3pol 4pol 5pol 9h 6h 6h	3pol 4pol 5pol 7h 7h 7h	3pol 4pol 5pol 10h 10h 10h	3pol 4pol 5pol 2h 2h 2h		
63	4			310490	310492			5	740
63	5			310494				5	785
Screw terminal:									
63	3	3108	3104	3109	31723	31606	31858	5	590
63	4	3149	3150	3151	3152	31085	31642	5	630
63	5	3153	3154	3112	31086	31500	31257	5	670

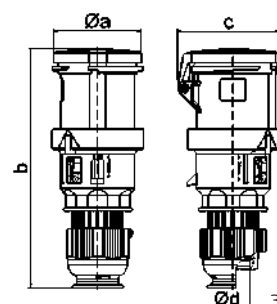

Ampere	63	63	63
Polzahl	3	4	5
ø a	95,0	95,0	95,0
b	251,0	251,0	251,0
c	109,0	109,0	109,0
ø d	36,0	36,0	36,0
Cond. mm² min	6	6	6
Cond. mm² max	16	16	16

Connector with MULTI-GRIP

- Screw terminals
- Nickel plated contacts
- One-piece enclosure
- Kontex contact
- Special gland, simultaneous cable gland and seal
- Protection degree IP67

MULTI GRIP



310346

Ampere	Polzahl	110V 50-60 Hz	230V 50-60 Hz	400V 50-60 Hz	500V 50-60 Hz	>50V 100-300Hz	>50V 301-500Hz	Quantity	Each
		3pol 4pol 5pol 4h 4h 4h	3pol 4pol 5pol 6h 9h 9h	3pol 4pol 5pol 9h 6h 6h	3pol 4pol 5pol 7h 7h 7h	3pol 4pol 5pol 10h 10h 10h	3pol 4pol 5pol 2h 2h 2h		
16	3	310331	310333	310334				10	175
16	4	310338	310339	310340				10	200
16	5	310344	310345	310346				10	220
32	3	310350	310351	310352				10	305
32	4	310356	310357	310358				10	315
32	5	310362	310363	310364				10	380

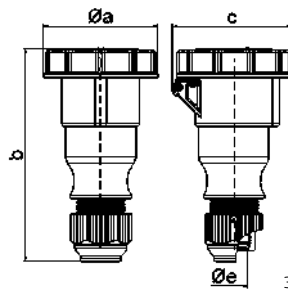

3 MB 81

Ampere	16	16	16	32	32	32
Polzahl	3	4	5	3	4	5
ø a	70,5	78,0	86,5	94,0	94,0	101,5
b	154,0	155,0	160,0	190,0	190,0	190,0
c	77,0	83,0	93,0	99,0	99,0	107,0
ø e	18,0	18,0	18,0	23,0	23,0	23,0
Cond. mm² min	1	1	1	2,5	2,5	2,5
Cond. mm² max	2,5	2,5	2,5	6	6	6

Connector TE-Plus with MULTI-GRIP

- Screwless terminals
- High-temperature-resistant contact carrier
- Kontex contact
- Nickel plated contacts
- Special gland, simultaneous cable gland and seal
- Protection degree IP67

QUICK CONNECT
MULTI GRIP



31243

Ampere	Polzahl	110V 50-60 Hz	230V 50-60 Hz	400V 50-60 Hz	500V 50-60 Hz	>50V 100-300Hz	>50V 301-500Hz	Quantity	Each
		3pol 4pol 5pol 4h 4h 4h	3pol 4pol 5pol 6h 9h 9h	3pol 4pol 5pol 9h 6h 6h	3pol 4pol 5pol 7h 7h 7h	3pol 4pol 5pol 10h 10h 10h	3pol 4pol 5pol 2h 2h 2h		
16	3	31298	31240	31299	31457	310554	310417	10	175
16	4	31301	31302	31241	31242	31303	31304	10	205
16	5	31305	31306	31243	31501		31409	10	245
32	3	31307	31244	31308				10	335
32	4	31309	31310	31245	31246	31311	31312	10	350
32	5	31313	31314	31247	31207		310415	10	410

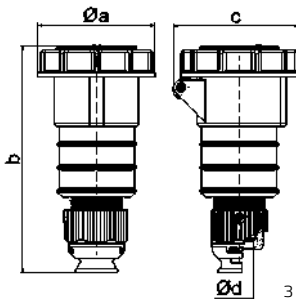

3 MB 63

Ampere	16	16	16	32	32	32
Polzahl	3	4	5	3	4	5
ø a	70,5	78,0	86,5	94,0	94,0	101,5
b	161,0	161,0	168,0	196,0	196,0	200,0
c	77,0	83,0	93,0	99,0	99,0	107,0
ø d	18,0	18,0	21,0	23,0	23,0	27,0
Cond. mm² min	1	1	1	2,5	2,5	2,5
Cond. mm² max	2,5	2,5	2,5	6	6	6

Connector TE-Plus with MULTI-GRIP

- High-temperature-resistant contact carrier
- Kontex contact
- Nickel plated contacts
- Special gland, simultaneous cable gland and seal
- Protection degree IP67

MULTI GRIP



310495

Ampere	Polzahl	110V 50-60 Hz	230V 50-60 Hz	400V 50-60 Hz	500V 50-60 Hz	>50V 100-300Hz	>50V 301-500Hz	Quantity	Each
		3pol 4pol 5pol 4h 4h 4h	3pol 4pol 5pol 6h 9h 9h	3pol 4pol 5pol 9h 6h 6h	3pol 4pol 5pol 7h 7h 7h	3pol 4pol 5pol 10h 10h 10h	3pol 4pol 5pol 2h 2h 2h		
63	4			310491	310493			5	800
63	5			310495				5	855
Screw terminal:									
63	3	3180	3181	3182	31724	31605		5	665
63	4	3183	3184	3185	3186	31504	31251	5	720
63	5	3187	3188	3124	31082	31505	31183	5	720

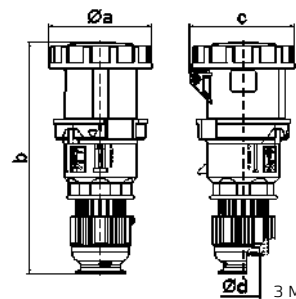

3 MB 109

Ampere	63	63	63
Polzahl	3	4	5
ø a	110,0	110,0	110,0
b	251,0	251,0	251,0
c	113,0	113,0	113,0
ø d	36,0	36,0	36,0
Cond. mm² min	6	6	6
Cond. mm² max	16	16	16

Connector TE with MULTI-GRIP

- Screw terminals
- Box terminals
- High-temperature-resistant contact carrier
- Kontex contact
- Nickel plated contacts
- Special gland, simultaneous cable gland and seal
- self locking
- Protection degree IP67

MULTI GRIP



3199

Ampere	Poles	110V	230V	400V	500V	>50V	>50V	Quantity	Each
		50-60 Hz	50-60 Hz	50-60 Hz	50-60 Hz	100-300Hz	301-500Hz		
125	3	3190	3191	3192				5	1130
125	4	3193	3194	3195	3196	31611		5	1230
125	5	3197	3198	3199	31417			5	1300

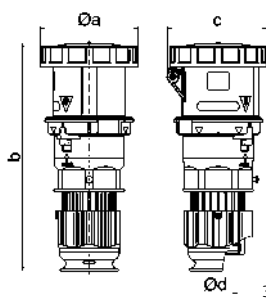

Ampere	125	125	125
Poles	3	4	5
Ø a	125,0	125,0	125,0
b	295,0	295,0	295,0
c	128,0	128,0	128,0
Ø d	50,0	50,0	50,0
Cond. mm² min	16	16	16
Cond. mm² max	50	50	50

3 MB 131

Connector QUICK-CONNECT lockable

- Screwless terminals
- Lockable with matching connector
- Screwless enclosure connection, self locking
- Special gland, simultaneous cable gland and seal
- Protection degree IP44

Accessories: Lock set, see page 110/5

QUICK CONNECT
MULTI GRIP



310635

Ampere	Poles	110V	230V	400V	500V	>50V	>50V	Quantity	Each
		50-60 Hz	50-60 Hz	50-60 Hz	50-60 Hz	100-300Hz	301-500Hz		
16	5			310634				10	190
32	5			310635				10	300

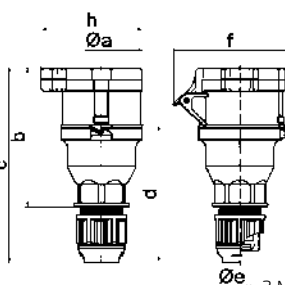

Ampere	16	32
Poles	5	5
Ø a	66,0	74,5
b	113,5	134,5
c	154,0	187,0
d	105,5	128,5
Ø e	18,0	23,0
f	86,0	97,0
h	82,0	100,0
Cond. mm² min	1	2,5
Cond. mm² max	2,5	6

3 MB 106

Hanging Connector TE-Plus with MULTI-GRIP

- Screwless terminals
- High-temperature-resistant contact carrier
- Kontex contact
- Nickel plated contacts
- Special gland, simultaneous cable gland and seal
- Protection degree IP44

QUICK CONNECT
MULTI GRIP



3214

Ampere	Poles	110V	230V	400V	500V	>50V	>50V	Quantity	Each
		50-60 Hz	50-60 Hz	50-60 Hz	50-60 Hz	100-300Hz	301-500Hz		
16	3	3208	3209					10	190
16	4			3210	3211	3213	3212	10	220
16	5			3214				10	260
32	3	3215	3216					10	
32	4			3217	3218	3220	3219	10	
32	5			3221				10	425

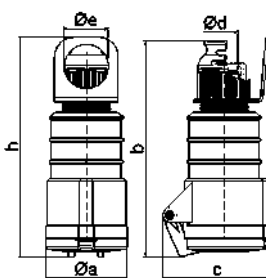

Ampere	16	16	16	32	32	32
Poles	3	4	5	3	4	5
Ø a	51,0	58,0	65,0	66,5	66,5	72,0
b	156,0	162,0	168,0	195,0	195,0	198,0
c	72,0	78,0	86,0	89,0	89,0	99,0
Ø d	18,0	18,0	21,0	23,0	23,0	27,0
Ø e	39,5	39,5	35,5	48,5	48,5	44,5
h	167,5	173,5	171,5	208,0	208,0	205,0
Cond. mm² min	1	1	1	2,5	2,5	2,5
Cond. mm² max	2,5	2,5	2,5	6	6	6

3 MB 74

Hanging Clip

- For plugs and connectors with MULTI-GRIP cable gland



58401

Ref. no.

for 16A	58400
for 32A	58401
for 63A and 125A	58402

Cable Gland Multi-Grip with Additional Strain Relief

- For plugs and connectors with MULTI-GRIP cable gland



29132

Ref. no.

for 16A / 3pol., 4pol. TE + TE-Plus + QC + TLS	29148
for 16A / 5pol. TE + TE-Plus	29149
for 32A / 5pol. TE + TE-Plus	29150
for 63A / 3pol., 4pol., 5pol. TE + TE-Plus	29132
for 125A / 3pol., 4pol., 5pol. TE	29133

Closure Cap

- For CEE plugs
- Protection degree IP67



832

Ref. no.

16A / 3pol. TE	830
16A / 4pol. TE	835
16A / 5pol., 7pol. TE	831
32A / 3pol., 4pol. TE	837
32A / 5pol., 7pol. TE	832
63A / 3pol., 4pol., 5pol.	833
125A / 3pol., 4pol., 5pol.	834

Reducer

- Suitable for cables less than Ø8mm
- For all 16A standard plugs and sockets with MULTI-GRIP as well as extra-low voltage



Ref. no.

29129

Lock Set

- For plugs/connectors of type 310634, 310635, 210950 and 210951
- With long shackle and 2 keys



Ref. no.

580642

1

2

3

4

5

6

7

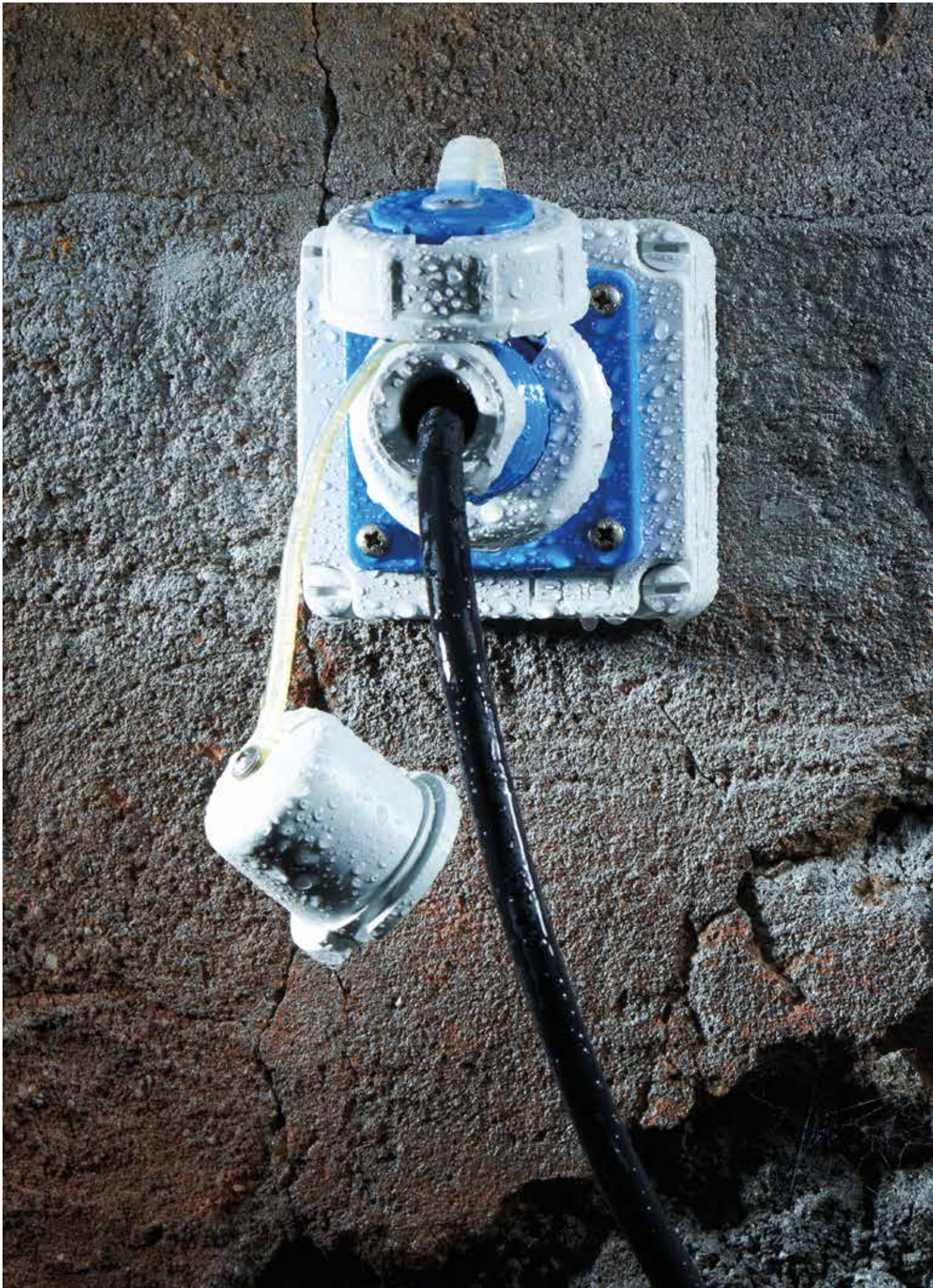



1

2

3

4

5

6

7

Domestic Panel Mounting Socket Outlets



Domestic Surface Mounting Socket Outlets



Domestic Plugs and Inlets



Domestic Connectors



Domestic Extension Leads

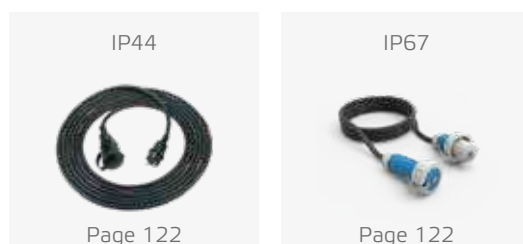

Technical features

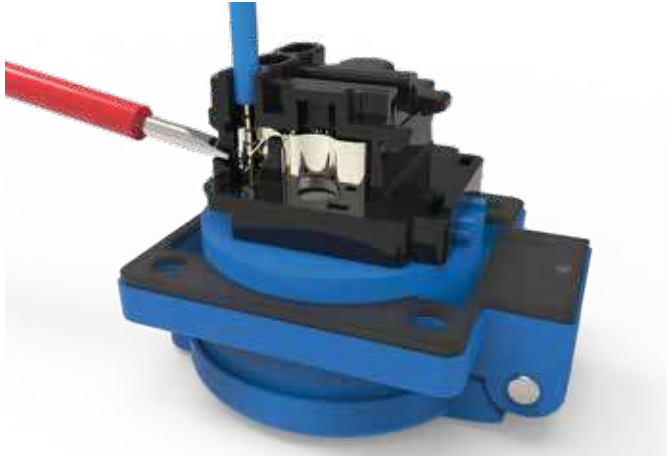

Domestic Panel Mounting Socket Outlets with QUICK CONNECT

- Screwless connection technology
- Robust terminal and enclosure design
- Special contact technology largely prevents contact deformation that can lead to a rise in temperature
- Flange dimensions in 50 x 50 mm and 75 x 75 mm
- Versions available for German, Swiss, or Belgian/French system



Domestic Panel Mounting Socket Outlets with QUICK CONNECT

- Captive flange seal
- Available as IP44 or IP54
- Also with child-proof safety feature on request
- Special colours on request
- VDE tested
- Touch-safe in accordance with BGV A3
- Nickel plated contacts



Usable conductor configurations

- Required stripping length and pin length with cable lugs 10 to 12 mm
- Solid conductor 1,5 mm² to 2,5 mm²
- Flexible conductor 1,5 mm² to 2,5 mm² with cable end ferrules, gas-tight crimp
- Flexible conductor 1,5 mm² to 2,5 mm² ultrasonically welded



1

2

3

4

5

6

7

The domestic plugs and connectors with a separated design and with the unique MULTI-GRIP cable gland. This integrated strain relief system invented by Bals, which has

proven itself for over 15 years, now makes installation even easier and, above all, safer in the area of domestic plugs and connectors.

MULTI GRIP

- MULTI-GRIP cable gland with integrated strain relief and seal
- Optimal strain relief for small and large cable diameters
- No time-consuming mounting of additional internal strain relief
- The time-consuming adjustment of onion rings to the cable diameter is eliminated
- Quick and safe closing of the cable gland due to the double thread

- The rubber seal that is fixed to the housing is captive and provides a reliable seal
- The condition of the strain relief can be checked from the outside at any time

Plug

- Protection degree IP44
- Easy and quick installation due to separated design
- Spacious connection area
- The alignment of the connections is the same for all contacts and the connection screws can therefore all be operated from one direction
- The housing and connection screws can be screwed with one and the same tool
- Cross sections of 1 mm² to 4 mm² can be connected without problem
- Also suitable for Belgian/French standard (plugs)
- Different colour variants (blue, red, black and grey) available

Connector

- Like plugs but also:
- Optional child protection
 - Also available in Belgian/French system
 - IP54



A spacious housing allows an uncomplicated installation.



Cross sections of 1 mm² to 4 mm² can be connected without problem.

Domestic Plugs and Sockets

German earthing system type F

Technical Information

- 16A / 250V~
- VDE 0620 / NBN C 61-112-1

Domestic Panel Mounting Socket Outlet

- Screw terminals
- Without hinged lid
- Connection at rear
- Nickel plated contacts
- Protection degree IP20

Type F - German standard



713

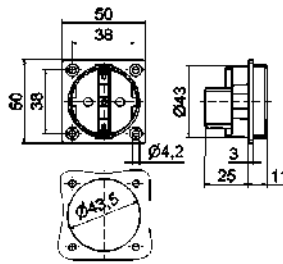

18 MB 1

Version	Colour	Order no.	Qty
Screw terminal	blue	713	20
Screw terminal	grey	712	20
Screw terminal	black	714	20

Domestic Panel Mounting Socket Outlet

- Hinged lid and injected flange gasket
- Flange 50 x 50 mm
- Mounting dimension 38 x 38 mm
- Connection terminal in accordance with BGV A2
- Nickel plated contacts
- Protection degree IP54

Type F - German standard



71099

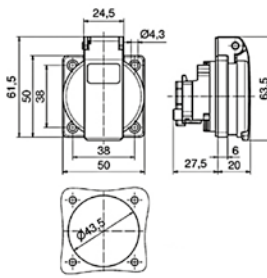

18 MB 102

Version	Colour	Order no.	Qty
QUICK CONNECT	blue	71099	20
QUICK CONNECT	grey	71100	20
QUICK CONNECT	black	71101	20
Screw terminal	blue	71094	20
Screw terminal	grey	71095	20
Screw terminal	black	71097	20

Domestic Panel Mounting Socket Outlet

- Flange 75 x 75 mm
- Mounting dimension 60 x 60 mm
- Nickel plated contacts
- Protection degree IP54

Type F - German standard



71108

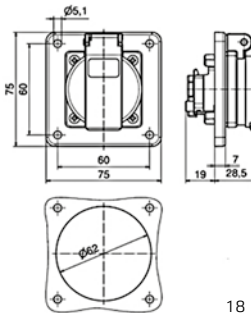

18 MB 107

Version	Colour	Order no.	Qty
QUICK CONNECT	blue	71108	20
QUICK CONNECT	grey	71109	20
QUICK CONNECT	black	71110	20
Screw terminal	blue	71105	20
Screw terminal	grey	71106	20
Screw terminal	black	71107	20

Domestic Panel Mounting Socket Outlet

- Screw terminals
- Flange 75 x 75 mm
- Mounting dimension 60 x 60 mm
- Nickel plated contacts
- Protection degree IP68

Type F - German standard



7112

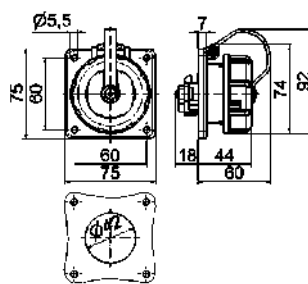

18 MB 19

Colour	Order no.	Qty
blue	7112	10
grey	7119	10

Domestic Panel Mounting Socket Outlet with Auxiliary Contact

- Screw terminals
- Flange 50 x 50 mm
- Mounting dimension 38 x 38 mm
- For measuring, regulating, controlling, acknowledging
- With hinged lid
- Nickel plated contacts
- Protection degree IP44

Type F - German standard



7168

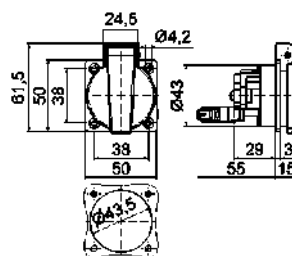

18 MB 36

Version	Colour	Order no.	Qty
NO contact	blue	7154	20
NC contact	blue	7168	20

Technical Information

- 16A / 250V~
- VDE 0620 / NBN C 61-112-1

Domestic Panel Mounting Socket Outlet

- Flange 50 x 50 mm
- Mounting dimension 38 x 38 mm
- Connection terminal in accordance with BGV A2
- Nickel plated contacts
- Protection degree IP54

Type E - Belgian/ French standard

QUICK CONNECT

7111809

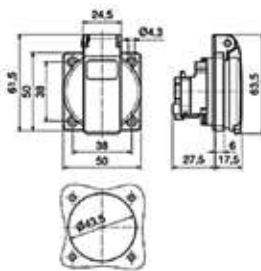

Version	Colour	Order no.	Qty
QUICK CONNECT	blue	71118	20
QUICK CONNECT	grey	71119	20
QUICK CONNECT	black	71120	20
QUICK CONNECT child-proof cover	blue	7111809	20
QUICK CONNECT child-proof cover	grey	7111909	20
QUICK CONNECT child-proof cover	black	7112009	20

18 MB 103

Domestic Panel Mounting Socket Outlet

- Screwless terminals
- Flange 75 x 75 mm
- Mounting dimension 60 x 60 mm
- Connection terminal in accordance with BGV A2
- Nickel plated contacts
- Protection degree IP54

Type E - Belgian/ French standard

QUICK CONNECT

7112109

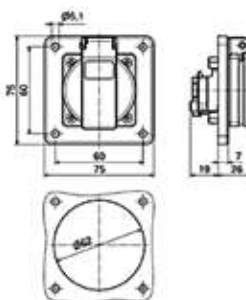

Version	Colour	Order no.	Qty
QUICK CONNECT	blue	71121	20
QUICK CONNECT	grey	71122	20
QUICK CONNECT	black	71123	20
QUICK CONNECT child-proof cover	blue	7112109	20
QUICK CONNECT child-proof cover	grey	7112209	20
QUICK CONNECT child-proof cover	black	7112309	20

18 MB 105

Domestic Panel Mounting Socket Outlet

- Screw terminals
- Flange 75 x 75 mm
- Mounting dimension 60 x 60 mm
- Nickel plated contacts
- Protection degree IP68

Type E - Belgian/ French standard

7153

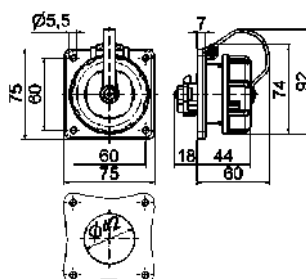

Colour	Order no.	Qty
blue	7153	10
grey	71028	10

18 MB 19

Domestic Panel Mounting Socket Outlet with Auxiliary Contact

- Screw terminals
- Flange 50 x 50 mm
- Mounting dimension 38 x 38 mm
- For measuring, regulating, controlling, acknowledging
- With hinged lid
- Nickel plated contacts
- Protection degree IP54

Type E - Belgian/ French standard

7163

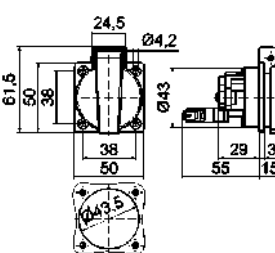

Version	Colour	Order no.	Qty
NO contact	blue	71001	20
NC contact	blue	7163	20

18 MB 36

Domestic Panel Mounting Socket Outlet

- Screw terminal
- Flange 50 x 50 mm
- Mounting dimension 38 x 38 mm
- Nickel plated contacts
- Protection degree IP44

Type G - British standard

18 MB 102

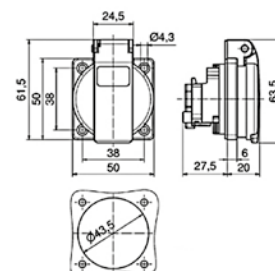

Colour	Order no.	Qty
blue	71142	10

18 MB 102

Domestic Plugs and Sockets

Danish earthing system type K

Technical Information

- 16A / 250V~
- VDE 0620 / NBN C 61-112-1

Domestic Panel Mounting Socket Outlet

- Screw terminal
- Flange 50 x 50 mm
- Mounting dimension 38 x 38 mm
- Nickel plated contacts
- Protection degree IP54

Type K - Danish standard

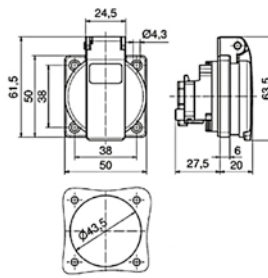

18 MB 102

Colour	Order no.	Qty
blue	71071	10

Domestic Surface Mounting Socket Outlet

- Dimension of enclosure 66 x 54 mm
- Protection degree IP44



724

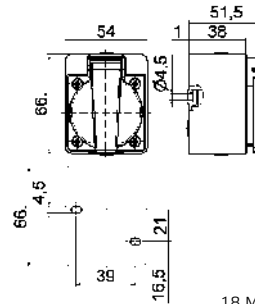

18 MB 35

Type	Colour	Order no.	Qty
German / F	blue	724	20
German / F	black	726	20

Domestic Surface Mounting Socket Outlet

- Dimension of enclosure 102 x 102 mm
- Protection degree IP67



7245

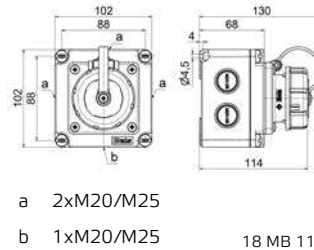

18 MB 114

Type	Colour	Order no.	Qty
German / F	blue	7245	10
Belg./French/E	blue	7246	10

Domestic Plug

- With Multi-Grip cable gland
- Spacious connection area
- Also suitable for Belgian/French system
- Protection degree IP44



MULTI GRIP

7370

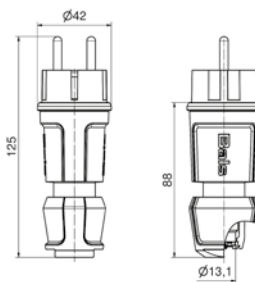

18 MB 119

Type	Colour	Order no.	Qty
German/F Belg./French/E	blue	7370	10
German/F Belg./French/E	grey	7371	10
German/F Belg./French/E	black	7372	10

Domestic Plug

- With cable gland
- Nickel plated contacts
- Also suitable for Belgian/French system
- With closure cap
- Protection degree IP67



736

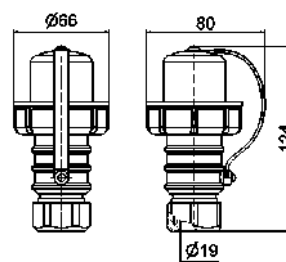

18 MB 18

Type	Colour	Order no.	Qty
German/F Belg./French/E	blue	736	10
German/F Belg./French/E	grey	737	10

Technical Information

- 16A / 250V~
- VDE 0620 / NBN C 61-112-1

Domestic Appliance Inlet with Flange

- With closure cap
- Nickel plated contacts
- Also suitable for Belgian/French system
- Protection degree IP67



754

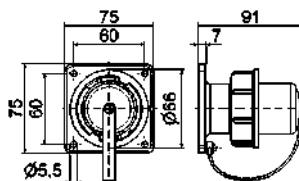

18 MB 16

Colour	Order no.	Qty
blue	754	10
grey	755	10

Domestic Connector

- Screw terminal
- With MULTI-GRIP cable gland
- Spacious connection area
- Protection degree IP54

Type F - German standard



MULTI GRIP

7486

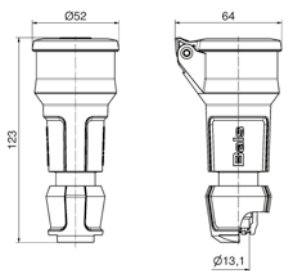

18 MB 120

Colour	Order no.	Qty
blue	7486	20
grey	7487	20
black	7488	20
red	7489	20

Domestic Connector with increased contact protection

- Screw terminal
- With MULTI-GRIP cable gland
- Spacious connection area
- Protection degree IP54

Type F - German standard



MULTI GRIP

748609

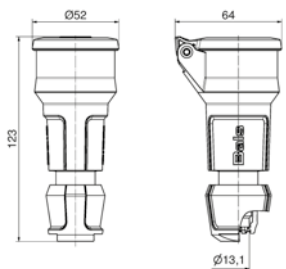

18 MB 120

Colour	Order no.	Qty
blue	748609	20
grey	748709	20
black	748809	20
red	748909	20

Domestic Connector with bleg. / france earthing system

- Screw terminal
- With MULTI-GRIP cable gland
- Spacious connection area
- Protection degree IP54

Type E - Belgian/ French standard



MULTI GRIP

7490

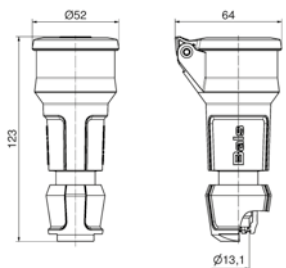

18 MB 120

Colour	Order no.	Qty
blue	7490	20
grey	7491	20
black	7492	20
red	7493	20

Domestic Connector with bleg. / france earthing system and with increased contact protection

- Screw terminal
- With MULTI-GRIP cable gland
- Spacious connection area
- Protection degree IP54

Type E Belgian/ French standard



MULTI GRIP

749009

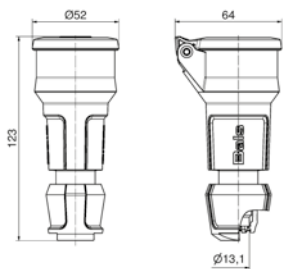

18 MB 120

Colour	Order no.	Qty
blue	749009	20
grey	749109	20
black	749209	20
red	749309	20

Domestic Plugs and Sockets

Appliance Inlets with Flange and Connectors

Technical Information

- 16A / 250V~
- VDE 0620 / NBN C 61-112-1

Domestic Connector

- With cable gland
- Nickel plated contacts
- Protection degree IP67



746

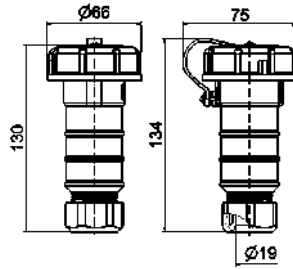

18 MB 26

Type	Colour	Order no.	Qty
German/F	blue	746	10
German/F	grey	747	10
Belg./French/E	blue	7416	10
Belg./French/E	grey	7455	10

Domestic Three-Way Connector

- With cable gland
- Nickel plated contacts
- With cover and hanging bracket
- Protection degree IP67



749

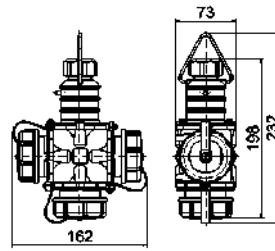

18 MB 27

Type	Colour	Order no.	Qty
German/F	blue	749	1
Belg./French/E	blue	7432	1

Extension Lead

- With domestic plug and connector
- Protection degree IP44



8156

Version	Length	Order no.	Qty
H07RN-F3G1,5	10m	8189	1
H07RN-F3G2,5	10m	8156	1
H07RN-F3G1,5	15m	8190	1
H07RN-F3G2,5	15m	8158	1
H07RN-F3G1,5	20m	8191	1
H07RN-F3G2,5	20m	8192	1

Extension Lead

- With watertight domestic plug and connector
- Protection degree IP67



8199

Version	Length	Order no.	Qty
H07RN-F3G1,5	10m	8198	1
H07RN-F3G2,5	10m	8199	1
H07RN-F3G1,5	15m	81000	1
H07RN-F3G2,5	15m	81001	1
H07RN-F3G1,5	20m	81002	1
H07RN-F3G2,5	20m	81003	1

Technical Information

- 16A / 250V~
- VDE 0620 / NBN C 61-112-1

1

2

3

4

5

6







7







- 1
- 2
- 3
- 4
- 5
- 6
- 7

Surface mounting distributors

<p>VARIABOX Technical properties</p>  <p>Pages 127 - 129</p>	<p>Plastic</p>  <p>Pages 130 - 143</p>	<p>Network sockets</p>  <p>Pages 140 - 141</p>	<p>Switched / interlocked</p>  <p>Pages 142</p>	<p>MODBOX Technical properties</p>  <p>Pages 144 - 145</p>
<p>Solid-Rubber</p>  <p>Pages 146 - 150</p>	<p>Stainless-Steel</p>  <p>Pages 151 - 154</p>			



Mobile distributors

<p>Plastic</p>  <p>Pages 156 - 157</p>	<p>EVOBOX</p>  <p>Pages 158 - 161</p>	<p>Solid-Rubber</p>  <p>Pages 162 - 170</p>
--	--	---



Hanging distributors

<p>Plastic</p>  <p>Pages 171 - 173</p>	<p>Solid-Rubber</p>  <p>Pages 174 - 176</p>
---	--

Bollards

<p>Distribution Bollards</p>  <p>Pages 177 - 179</p>	<p>Power-Ports</p>  <p>Pages 179</p>
---	---

Accessories

<p>Plastic Enclosures</p>  <p>Page 180</p>	<p>Accessories</p>  <p>Pages 181 - 185</p>
---	---

VARIABOX

The Bals VARIABOX distributor system is even more versatile and flexible. As an adaptive further development, the new network data sockets as well as the switched interlocked CEE sockets are now available. Thus, the distributors can now be equipped with RJ45, HDMI or USB connections if necessary.

The coded flange plate with separate switch accommodates the mechanically interlocked panel mounting socket from 16A 3-pole to 32A 5-pole in IP44 or IP67 and can be perfectly integrated optically in the overall system.

Thus, the VARIABOX once again lives up to its reputation as a true all-rounder among the distributor systems. With the S, M, L, XL and XXL versions as wall-mounted or mobile combination, you will always find the right distributor for your needs – flexibly and individually configurable. A decisive advantage of the distributor is its freedom from maintenance: all panel mounting sockets are equipped with the touch-safe QUICK-CONNECT connection technology. Also unique is the operating window with OTC mechanism (one touch close).

Variabox extension – switching bar:

- Perfect optical integration in the existing system
- User-friendly arrangement in the case of multiple units
- Mechanical double-interlocking
- Can be locked in the 0-position
- Nickel plated contacts
- High-temperature-resistant contact carriers
- Greater flexibility in the Variabox system landscape
- Suitable for harsh environmental conditions
- Versions in all voltages and frequencies from 16A 3-pole to 32A 5-pole
- Protection degrees IP44, IP54 and IP67

Variabox extension – network socket:

- Perfect optical integration in the existing system
- Optionally equipped with RJ45, HDMI or USB
- Various data technology inserts available
- With protection against contact
- Protection degree IP54
- Greater flexibility in the Variabox system landscape
- Can be closed with the plugs plugged in, optionally lockable
- With labelling fields



Detailed view of switched interlocked flange plate.



The network socket with various data inserts.

Technical Data

Sizes

Version	Dimensions (H x W x D)
VARIABOX-S	130 x 230 x 145 mm
VARIABOX-M	260 x 230 x 145 mm
VARIABOX-L	390 x 230 x 145 mm
VARIABOX-XL	520 x 230 x 145 mm
VARIABOX-XXL	650 x 230 x 145 mm
VARIABOX-L DUO	390 x 460 x 145 mm
VARIABOX-XL DUO	520 x 460 x 145 mm

further modular extension possible

Colours

Top grey (standard) RAL 7035
 Top yellow, available as of 5 units
 Top blue, available as of 5 units
 Top red, available as of 5 units
 Top silver, available as of 5 units
 Bottom black RAL 9005

Shape

Cover straight,
 CEE socket angled

Material

PBT polyester

Material properties

Self-extinguishing, heat-resistant, extremely cold-resistant, resistant to ageing, saltwater-resistant, good electric insulation properties, fracture-proof, wear-resistant, abrasion-resistant, dimensionally stable

Durable

High chemical resistance, UV-stabilised, suitable for use in hostile environments

Impact resistance

IK09

Thermal resistance

DIN EN 61439 / VDE 0660-600

Ageing resistance

Long-term testing at +80 degrees

Glow wire test

In accordance with
 DIN EN60695

Protection

Top can be lead-sealed to bottom,
 OTC window can be lead-sealed

Wall mounting

Either internal or external fastening

Cover attachment

Hinged on right, can be hinged on left on request

Cover screws

Captive, with internal and external hexagon, including slot, torque 2 Nm

Cable entry

Face plates pre-punched at top and bottom
 each with M12, M20, M25/M32/M40

Attachments

User-friendly OTC mechanism (One Touch Close), CEE sockets 16A to 63A with maintenance-free QUICK-CONNECT technology, data sockets, intercompatibility of mounted sockets, optionally available with handle

Protection class

IP44, IP54, IP67

Environment

PVC-free, cadmium-free, halogen-free and silicone-free

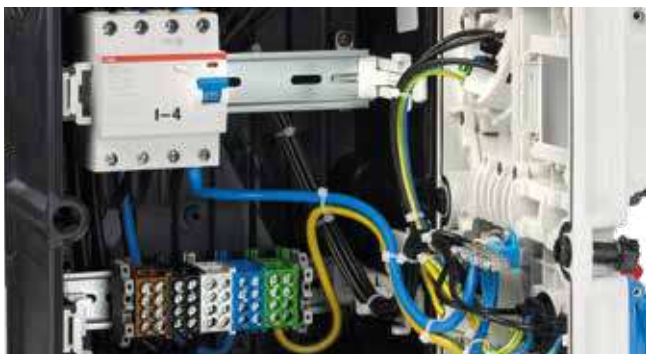

Proper and clearly arranged wiring and an automated safety



All mounted sockets with maintenance-free QUICK-CONNECT-technology



Operating window with the unique OTC mechanism



The metric cable entries at the top and bottom

1

VARIABOX-S

30MB208

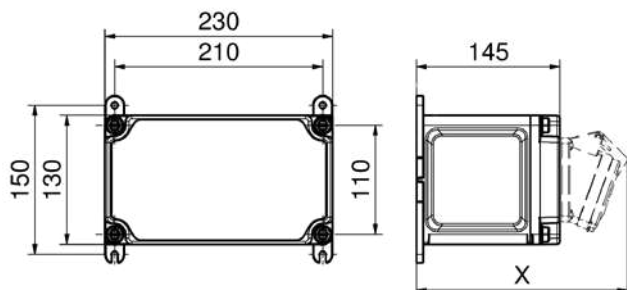

Standard cable entries pre-punched
Top: 1xM12, 1xM20, 2xM25 oder 2xM32
Bottom: 1xM12, 1xM20, 2xM25 oder 2xM32

VARIABOX-M

30MB207

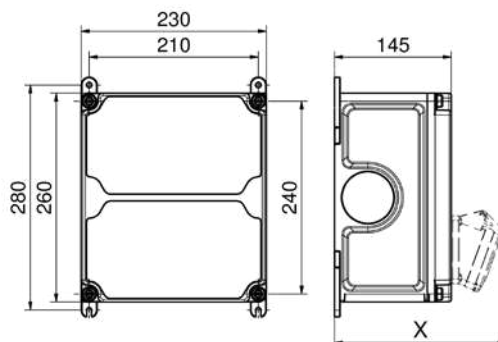

Standard cable entries pre-punched
Top: 1xM12, 1xM20, 2xM32 oder 2xM40
Bottom: 1xM12, 1xM20, 2xM32 oder 2xM40

2

VARIABOX-L

30MB206

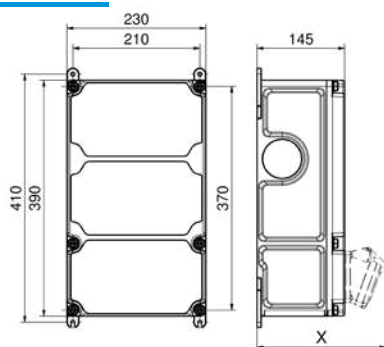

Standard cable entries pre-punched
Top: 1xM12, 1xM20, 2xM40
Bottom: 1xM12, 1xM20, 2xM40

VARIABOX-XL

30MB205

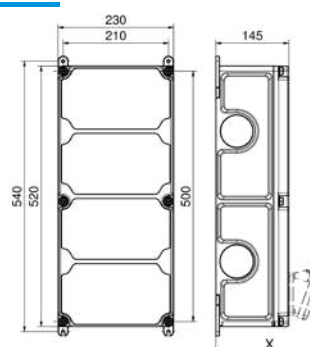

Standard cable entries pre-punched
Top: 1xM12, 1xM20, 2xM40
Bottom: 1xM12, 1xM20, 2xM40

3

4

VARIABOX-XXL

30MB204

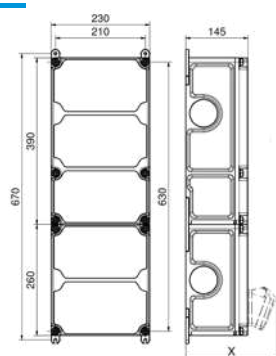

Standard cable entries pre-punched
Top: 1xM12, 1xM20, 2xM40
Bottom: 1xM12, 1xM20, 2xM40

VARIABOX-L DUO

30MB214

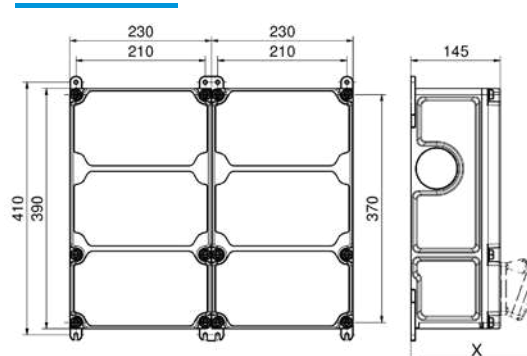

Standard cable entries pre-punched
Top: 1xM12, 1xM20, 2xM40
Bottom: 1xM12, 1xM20, 2xM40

5

6

Table X-dimension

Components	Operation window	Domestic socket		CEE 16A 3pole		CEE 16A 4pole		CEE 16A 5pole		CEE 32A 3/4pole		CEE 32A 5pole		CEE 63A	
Protection class		IP44	IP67	IP44	IP67	IP44	IP67	IP44	IP67	IP44	IP67	IP44	IP67	IP44	IP67
Depth X	180	162	205	200	200	204	202	207	205	211	213	213	214	229	231

7

Technical information

- Wired ready for connection
- Protection degree IP44
- All distributors comply with the DIN EN 61439 / IEC 61439

- Housing made of high-grade, impact-resistant plastic
- Top and bottom can be sealed together
- With external and internal fastening
- Permanently attached cover screws
- Top section straight, CEE sockets angled
- All CEE sockets with screwless, maintenance-free QUICK-CONNECT technology
- Colours: bottom - black, top - electro-grey (housing top optionally available in the colours yellow, red or blue)

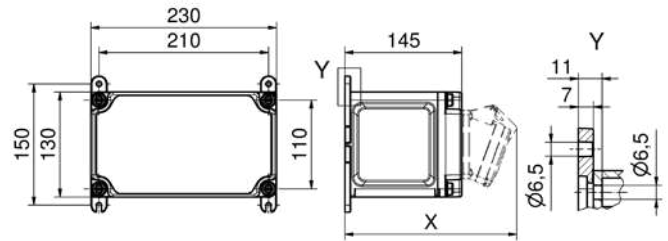

Depth X (in mm)

Component	IP44	IP67	Component	IP44	IP67
OTC-window	180	180	CEE 16A 5p	207	205
Domestic socket	162	205	CEE 32A 3p / 4p	211	213
CEE 16A 3p	200	200	CEE 32A 5p	213	214
CEE 16A 4p	204	202	CEE 63A 3p / 4p / 5p	229	231

Ref. no. **89003**



Components:

3 domestic sockets 16A, 230V (type F - German standard)

Cable entry at top and bottom: each with 1x M12, 1x M20, 2x M25

Connection option: for 1 cable up to 5 x 6 mm²



Ref. no. **89006**

Components:

4 domestic sockets 16A, 230V (type F - German standard)

Cable entry at top and bottom: each with 1x M12, 1x M20, 2x M25

Connection option: for 1 cable up to 5 x 6 mm²



Ref. no. **89002**

Components:

1 domestic socket 16A, 230V (type F - German standard)
1 CEE socket 16A, 400V, 5p

Cable entry at top and bottom: each with 1x M12, 1x M20, 2x M25

Connection option: for 1 cable up to 5 x 6 mm²



Ref. no. **89004**

Components:

2 domestic sockets 16A, 230V (type F - German standard)
1 CEE socket 16A, 400V, 5p

Cable entry at top and bottom: each with 1x M12, 1x M20, 2x M25

Connection option: for 1 cable up to 5 x 6 mm²



Ref. no. **89000**

Components:

2 CEE sockets 16A, 400V, 5p

Cable entry at top and bottom: each with 1x M12, 1x M20, 2x M25

Connection option: for 1 cable up to 5 x 6 mm²



Ref. no. **895347**

Components:

2 domestic sockets 16A, 230V (type F - German standard)
2 RJ45 CAT6a below operating window, can be closed with the plugs plugged in

Cable entry at top and bottom:
1 cable gland M20 top
1 cable gland M25 with multiple sealing insert 2 x 8 mm top
1 x M20, 1 x M25 bottom

Connection option: for 1 cable up to 3 x 6 mm²



Technical information

- Wired ready for connection
- Protection degree IP44
- All distributors comply with the DIN EN 61439 / IEC 61439

- Housing made of high-grade, impact-resistant plastic
- Hinged lid
- Top and bottom can be sealed together
- With external and internal fastening
- User-friendly OTC operating window
- Permanently attached cover screws
- Coded flange plate system for maximum safety during initial installation and maintenance
- Top section straight, CEE sockets angled
- All CEE sockets with screwless, maintenance-free QUICK-CONNECT technology
- Colours: bottom - black, top - electro-grey (housing top optionally available in the colours yellow, red or blue)

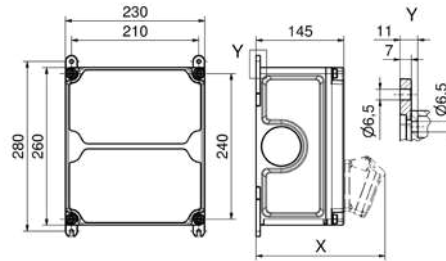

30 MB 207

Depth X (in mm)

Component	IP44	IP67	Component	IP44	IP67
OTC-window	180	180	CEE 16A 5p	207	205
Domestic socket	162	205	CEE 32A 3p / 4p	211	213
CEE 16A 3p	200	200	CEE 32A 5p	213	214
CEE 16A 4p	204	202	CEE 63A 3p / 4p / 5p	229	231

Ref. no. **89016**



Components:

3 domestic sockets 16A, 230V
(type F - German standard)

Fuse:

3 C-type MCBs 16A, 1p
1 RCCB 40/0.03A, 4p

Cable entry at top and bottom:

each with 1x M12, 1x M20, 2x M32

Connection option:

for 2 cables up to 5 x 25 mm²



Ref. no. **890400**

Components:

3 domestic sockets 16A, 230V
(type F - German standard)
1 double data socket RJ45 CAT6a IP55

Fuse:

3 C-type MCBs 16A, 1p
1 RCCB 40/0.03A, 4p

Cable entry at top and bottom:

each with 2x M20, 2x M32

Connection option:

for 2 cables up to 5 x 25 mm²



Ref. no. **89040**

Components:

4 domestic sockets 16A, 230V
(type F - German standard)

Fuse:

4 C-type MCBs 16A, 1p
1 RCCB 40/0.03A, 4p

Cable entry at top and bottom:

each with 1x M12, 1x M20, 2x M32

Connection option:

for 2 cables up to 5 x 25 mm²



Ref. no. **89037**

Components:

8 domestic sockets 16A, 230V
(type F - German standard)

Cable entry at top and bottom:

each with 1x M12, 1x M20, 2x M25

Connection option:

for 1 cable 5 x 6 mm²



Ref. no. **89044**



Components:

2 domestic sockets 16A, 230V
(type F - German standard)
1 CEE socket 16A, 400V, 5p

Fuse:

2 Neozed D01, 1p
1 Neozed D01, 3p

Cable entry at top and bottom:

each with 1x M12, 1x M20, 2x M40

Connection option:

for 2 cables up to 5 x 25 mm²



Ref. no. **89010**



Components:

2 domestic sockets 16A, 230V
(type F - German standard)
1 CEE socket 16A, 400V, 5p

Fuse:

2 C-type MCBs 16A, 1p
1 C-type MCB 16A, 3p
1 RCCB 40/0.03A, 4p

Cable entry at top and bottom:

each with 1x M12, 1x M20, 2x M40

Connection option:

for 2 cables up to 5 x 25 mm²



Technical information

- Wired ready for connection
- Protection degree IP44
- All distributors comply with the DIN EN 61439 / IEC 61439

Ref. no. **89015**

Components:

2 domestic sockets 16A, 230V (type F - German standard)
1 CEE socket 32A, 400V, 5p

Fuse:

2 Neozed D01, 1p
1 Neozed D02, 3p

Cable entry at top and bottom:

each with 1x M12, 1x M20, 2x M40

Connection option:

for 2 cables up to 5 x 25 mm²



Ref. no. **89013**

Components:

2 domestic sockets 16A, 230V (type F - German standard)
1 CEE socket 32A, 400V, 5p

Fuse:

2 C-type MCBs 16A, 1p
1 C-type MCB 32A, 3p
1 RCCB 40/0.03A, 4p

Cable entry at top and bottom:

each with 1x M12, 1x M20, 2x M40

Connection option:

for 2 cables up to 5 x 25 mm²



Ref. no. **89017**

Components:

2 CEE sockets 16A, 400V, 5p

Fuse:

2 C-type MCBs 16A, 3p
1 RCCB 40/0.03A, 4p

Cable entry at top and bottom:

each with 1x M12, 1x M20, 2x M40

Connection option:

for 2 cables up to 5 x 25 mm²



Ref. no. **89028**

Components:

2 domestic sockets 16A, 230V (type F - German standard)
2 CEE sockets 16A, 400V, 5p

Cable entry at top and bottom:

each with 1x M12, 1x M20, 2x M25

Connection option:

for 1 cable 3 x 4 mm² and
1 cable 5 x 4 mm²



Ref. no. **89038**

Components:

5 domestic sockets 16A, 230V (type F - German standard)
1 CEE socket 16A, 400V, 5p

Cable entry at top and bottom:

each with 1x M12, 1x M20, 2x M25

Connection option:

for 1 cable up to 5 x 6 mm²



Ref. no. **89022**

Components:

1 CEE socket 16A, 400V, 5p
1 CEE socket 32A, 400V, 5p

Fuse:

1 Neozed D01, 3p
1 Neozed D02, 3p

Cable entry at top and bottom:

each with 1x M12, 1x M20, 2x M40

Connection option:

for 2 cables up to 5 x 25 mm²



Ref. no. **89048**

Components:

1 CEE socket 16A, 400V, 5p
1 CEE socket 32A, 400V, 5p

Fuse:

1 C-type MCB 16A, 3p
1 C-type MCB 32A, 3p
1 RCCB 40/0.03A, 4p

Cable entry at top and bottom:

each with 1x M12, 1x M20, 2x M40

Connection option:

for 2 cables up to 5 x 25 mm²



Ref. no. **890011**

Components:

2 CEE sockets 32A, 400V, 5p

Fuse:

2 C-type MCBs 32A, 3p
1 RCCB 63/0.03A, 4p

Cable entry at top and bottom:

each with 1x M12, 1x M20, 2x M40

Connection option:

for 2 cables up to 5 x 25 mm²



Technical information

- Wired ready for connection
- Protection degree IP44
- All distributors comply with the DIN EN 61439 / IEC 61439

- Housing made of high-grade, impact-resistant plastic
- Hinged lid
- Top and bottom can be sealed together
- With external and internal fastening
- User-friendly OTC operating window
- Permanently attached cover screws
- Coded flange plate system for maximum safety during initial installation and maintenance
- Top section straight, CEE sockets angled
- All CEE sockets with screwless, maintenance-free QUICK-CONNECT technology
- Colours: bottom - black, top - electro-grey (housing top optionally available in the colours yellow, red or blue)

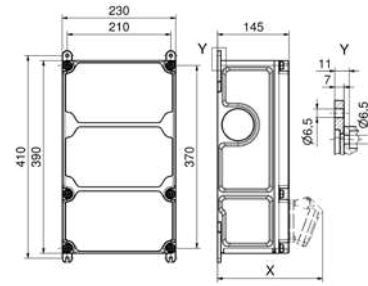

30 MB 206

Depth X (in mm)

Component	IP44	IP67	Component	IP44	IP67
OTC-window	180	180	CEE 16A 5p	207	205
Domestic socket	162	205	CEE 32A 3p / 4p	211	213
CEE 16A 3p	200	200	CEE 32A 5p	213	214
CEE 16A 4p	204	202	CEE 63A 3p / 4p / 5p	229	231

Ref. no. **89084**

Components:

6 domestic sockets 16A, 230V
(system F - German earthing system)(type F - German standard)

Fuse:

6 C-type MCBs 16A, 1p
1 RCCB 40/0.03A, 4p

Cable entry at top and bottom:

each with 1x M12, 1x M20, 2x M40

Connection option:

for 2 cables up to 5 x 25 mm²



Ref. no. **89085**

Components:

2 domestic sockets 16A, 230V
(type F - German standard)
2 CEE sockets 16A, 400V, 5p

Fuse:

2 Neozed D01, 1p
2 Neozed D01, 3p

Cable entry at top and bottom:

each with 1x M12, 1x M20, 2x M40

Connection option:

for 2 cables up to 5 x 25 mm²



Ref. no. **89075**

Components:

2 domestic sockets 16A, 230V
(type F - German standard)
2 CEE sockets 16A, 400V, 5p

Fuse:

2 C-type MCBs 16A, 1p
2 C-type MCBs 16A, 3p
1 RCCB 40/0.03A, 4p

Cable entry at top and bottom:

each with 1x M12, 1x M20, 2x M40

Connection option:

for 2 cables up to 5 x 25 mm²



Ref. no. **89086**

Components:

2 domestic sockets 16A, 230V
(type F - German standard)
1 CEE socket 16A, 400V, 5p
1 CEE socket 32A, 400V, 5p

Fuse:

2 Neozed D01, 1p
1 Neozed D01, 3p
1 Neozed D02, 3p

Cable entry at top and bottom:

each with 1x M12, 1x M20, 2x M40

Connection option:

for 2 cables up to 5 x 25 mm²



Ref. no. **89076**

Components:

2 domestic sockets 16A, 230V
(type F - German standard)
1 CEE socket 16A, 400V, 5p
1 CEE socket 32A, 400V, 5p

Fuse:

2 C-type MCBs 16A, 1p
1 C-type MCB 16A, 3p
1 C-type MCB 32A, 3p
1 RCCB 40/0.03A, 4p

Cable entry at top and bottom:

each with 1x M12, 1x M20, 2x M40

Connection option:

for 2 cables up to 5 x 25 mm²



Ref. no. **89070**

Components:

3 domestic sockets 16A, 230V
(type F - German standard)
1 CEE socket 16A, 400V, 5p
1 CEE socket 32A, 400V, 5p

Fuse:

3 C-type MCBs 16A, 1p
1 C-type MCB 16A, 3p
1 C-type MCB 32A, 3p

Cable entry at top and bottom:

each with 1x M12, 1x M20, 2x M40

Connection option:

for 2 cables up to 5 x 25 mm²



Technical information

- Wired ready for connection
- Protection degree IP44
- All distributors comply with the DIN EN 61439 / IEC 61439

- Housing made of high-grade, impact-resistant plastic
- Hinged lid
- Top and bottom can be sealed together
- With external and internal fastening
- User-friendly OTC operating window
- Permanently attached cover screws
- Coded flange plate system for maximum safety during initial installation and maintenance
- Top section straight, CEE sockets angled
- All CEE sockets with screwless, maintenance-free QUICK-CONNECT technology
- Colours: bottom - black, top - electro-grey (housing top optionally available in the colours yellow, red or blue)

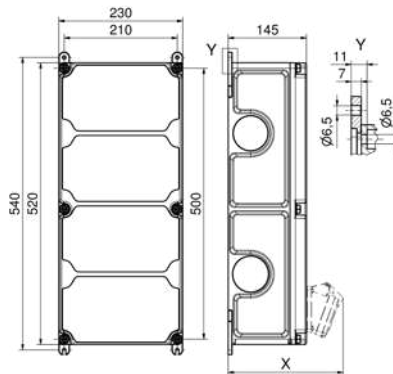

Depth X (in mm)

Component	IP44	IP67
OTC-window	180	180
Domestic socket	162	205
CEE 16A 3p	200	200
CEE 16A 4p	204	202
CEE 16A 5p	207	205
CEE 32A 3p / 4p	211	213
CEE 32A 5p	213	214
CEE 63A 3p / 4p / 5p	229	231

30 MB 205

Ref. no. **89146**

Components:

2 domestic sockets 16A, 230V (type F - German standard)
2 CEE sockets 32A, 400V, 5p

Fuse:

2 Neozed D01, 1p
2 Neozed D02, 3p

Cable entry at top and bottom:

each with 1x M12, 1x M20, 2x M40

Connection option:

for 2 cables up to 5 x 25 mm²



Ref. no. **89107**

Components:

3 domestic sockets 16A, 230V (type F - German standard)
2 CEE sockets 32A, 400V, 5p

Fuse:

3 C-type MCBs 16A, 1p
2 C-type MCBs 32A, 3p
1 RCCB 63/0.03A, 4p

Cable entry at top and bottom:

each with 1x M12, 1x M20, 2x M40

Connection option:

for 2 cables up to 5 x 25 mm²



Ref. no. **89094**

Components:

2 domestic sockets 16A, 230V (type F - German standard)
1 CEE socket 16A, 400V, 5p
1 CEE socket 32A, 400V, 5p

Fuse:

2 Neozed D01, 1p
1 Neozed D01, 3p
1 Neozed D02, 3p
1 RCCB 63/0.03A, 4p

Cable entry at top and bottom:

each with 1x M12, 1x M20, 2x M40

Connection option:

for 2 cables up to 5 x 25 mm²



Ref. no. **89099**

Components:

3 domestic sockets 16A, 230V (type F - German standard)
1 CEE socket 16A, 400V, 5p
1 CEE socket 32A, 400V, 5p

Fuse:

3 C-type MCBs 16A, 1p
1 C-type MCB 16A, 3p
1 C-type MCB 32A, 3p
1 RCCB 63/0.03A, 4p

Cable entry at top and bottom:

each with 1x M12, 1x M20, 2x M40

Connection option:

for 2 cables up to 5 x 25 mm²



Ref. no. **89101**

Components:

4 domestic sockets 16A, 230V (type F - German standard)
1 CEE socket 16A, 400V, 5p
1 CEE socket 32A, 400V, 5p

Fuse:

4 C-type MCBs 16A, 1p
1 C-type MCB 16A, 3p
1 C-type MCB 32A, 3p
1 RCCB 40/0.03A, 4p

Cable entry at top and bottom:

each with 1x M12, 1x M20, 2x M40

Connection option:

for 2 cables up to 5 x 25 mm²



Ref. no. **89095**

Components:

2 domestic sockets 16A, 230V (type F - German standard)
1 CEE socket 16A, 400V, 5p
1 CEE socket 32A, 400V, 5p
1 CEE socket 63A, 400V, 5p

Fuse:

2 C-type MCBs 16A, 1p
1 C-type MCB 16A, 3p
1 C-type MCB 32A, 3p
1 RCCB 63/0.03A, 4p

Cable entry at top and bottom:

each with 1x M12, 1x M20, 2x M40

Connection option:

for 2 cables up to 5 x 25 mm²



Technical information

- Wired ready for connection
- Protection degree IP44
- All distributors comply with the DIN EN 61439 / IEC 61439

- Housing made of high-grade, impact-resistant plastic
- Hinged lid
- Top and bottom can be sealed together
- With external and internal fastening
- User-friendly OTC operating window
- Permanently attached cover screws
- Coded flange plate system for maximum safety during initial installation and maintenance
- Top section straight, CEE sockets angled
- All CEE sockets with screwless, maintenance-free QUICK-CONNECT technology
- Colours: bottom - black, top - electro-grey (housing top optionally available in the colours yellow, red or blue)

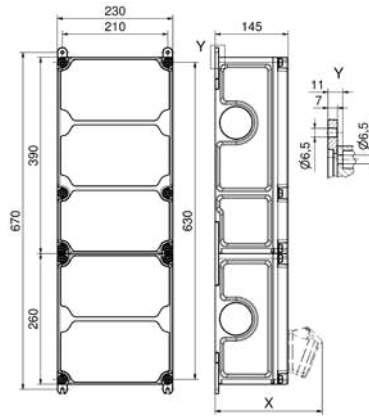

Depth X (in mm)

Component	IP44	IP67
OTC-window	180	180
Domestic socket	162	205
CEE 16A 3p	200	200
CEE 16A 4p	204	202
CEE 16A 5p	207	205
CEE 32A 3p / 4p	211	213
CEE 32A 5p	213	214
CEE 63A 3p / 4p / 5p	229	231

30 MB 204

Ref. no. **89127**

Components:

4 domestic sockets 16A, 230V
(type F - German standard)
3 CEE sockets 16A, 400V, 5p

Fuse:

4 C-type MCBs 16A, 1p
3 C-type MCBs 16A, 3p
1 RCCB 63/0.03A, 4p

Cable entry at top and bottom:

each with 1x M12, 1x M20, 2x M40

Connection option:

for 2 cables up to 5 x 25 mm²



Ref. no. **89122**

Components:

6 CEE sockets 16A, 230V, 3p

Fuse:

6 C-type MCBs 16A, 1p
6 RCCB 25/0.03A, 2p

Cable entry at top and bottom:

each with 1x M12, 1x M20, 2x M40

Connection option:

for 2 cables up to 5 x 25 mm²

Not suitable for camping / marina



Ref. no. **89120**

Components:

6 domestic sockets 16A, 230V
(type F - German standard)
1 CEE socket 16A, 400V, 5p
1 CEE socket 32A, 400V, 5p

Fuse:

6 C-type MCBs 16A, 1p
1 C-type MCB 16A, 3p
1 C-type MCB 32A, 3p
1 RCCB 63/0.03A, 4p

Cable entry at top and bottom:

each with 1x M12, 1x M20, 2x M40

Connection option:

for 2 cables up to 5 x 25 mm²



Ref. no. **89119**

Components:

4 domestic sockets 16A, 230V
(type F - German standard)
2 CEE sockets 16A, 400V, 5p
1 CEE socket 32A, 400V, 5p

Fuse:

4 C-type MCBs 16A, 1p
2 C-type MCBs 16A, 3p
1 C-type MCB 32A, 3p
1 RCCB 63/0.03A, 4p

Cable entry at top and bottom:

each with 1x M12, 1x M20, 2x M40

Connection option:

for 2 cables up to 5 x 25 mm²



Ref. no. **89142**

Components:

3 domestic sockets 16A, 230V
(type F - German standard)
2 CEE sockets 16A, 400V, 5p
2 CEE sockets 32A, 400V, 5p

Fuse:

3 C-type MCBs 16A, 1p
2 C-type MCBs 16A, 3p
2 C-type MCBs 32A, 3p
1 RCCB 63/0.03A, 4p

Cable entry at top and bottom:

each with 1x M12, 1x M20, 2x M40

Connection option:

for 2 cables up to 5 x 25 mm²



Ref. no. **89123**

Components:

2 domestic sockets 16A, 230V
(type F - German standard)
1 CEE socket 16A, 400V, 5p
1 CEE socket 32A, 400V, 5p
1 CEE socket 63A, 400V, 5p

Fuse:

2 C-type MCBs 16A, 1p
1 C-type MCB 16A, 3p
1 C-type MCB 32A, 3p
1 Neozed D02, 3p
1 RCCB 63/0.03A, 4p

Cable entry at top and bottom:

each with 1x M12, 1x M20, 2x M40

Connection option:

for 2 cables up to 5 x 25 mm²



Technical information

- Wired ready for connection
- Protection degree IP44
- All distributors comply with the DIN EN 61439 / IEC 61439

- Housing made of high-grade, impact-resistant plastic
- Hinged lid
- Top and bottom can be sealed together
- With external and internal fastening
- User-friendly OTC operating window
- Permanently attached cover screws
- Coded flange plate system for maximum safety during initial installation and maintenance
- Top section straight, CEE sockets angled
- All CEE sockets with screwless, maintenance-free QUICK-CONNECT technology
- Colours: bottom - black, top - electro-grey (housing top optionally available in the colours yellow, red or blue)

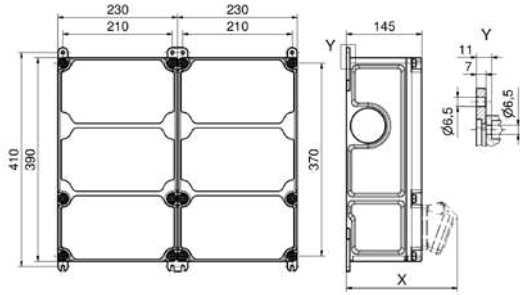

30 MB 214

Depth X (in mm)

Component	IP44	IP67	Component	IP44	IP67
OTC-window	180	180	CEE 16A 5p	207	205
Domestic socket	162	205	CEE 32A 3p / 4p	211	213
CEE 16A 3p	200	200	CEE 32A 5p	213	214
CEE 16A 4p	204	202	CEE 63A 3p / 4p / 5p	229	231

Ref. no. **89128**

Components:

- 4 domestic sockets 16A, 230V (type F - German standard)
- 3 CEE sockets 16A, 400V, 5p

Fuse:

- 4 Neozed D01, 1p
- 3 Neozed D01, 3p

Cable entry at top and bottom:

each with 1x M12, 1x M20, 2x M40

Connection option:

for 2 cables up to 5 x 25 mm²



Ref. no. **89129**

Components:

- 4 domestic sockets 16A, 230V (type F - German standard)
- 1 CEE socket 16A, 230V, 3p
- 1 CEE socket 16A, 400V, 5p
- 1 CEE socket 32A, 400V, 5p

Fuse:

- 5 Neozed D01, 1p
- 1 Neozed D01, 3p
- 1 Neozed D02, 3p
- 1 RCCB 63/0.03A, 4p

Cable entry at top and bottom:

each with 1x M12, 1x M20, 2x M40

Connection option:

for 2 cables up to 5 x 25 mm²



Ref. no. **89134**

Components:

- 4 domestic sockets 16A, 230V (type F - German standard)
- 2 CEE sockets 16A, 400V, 5p
- 1 CEE socket 32A, 400V, 5p

Fuse:

- 4 Neozed D01, 1p
- 2 Neozed D01, 3p
- 1 Neozed D02, 3p
- 1 RCCB 63/0.03A, 4p

Cable entry at top and bottom:

each with 1x M12, 1x M20, 2x M40

Connection option:

for 2 cables up to 5 x 25 mm²



Ref. no. **890083**

Components:

- 4 domestic sockets 16A, 230V (type F - German standard)
- 1 CEE socket 16A, 400V, 5p
- 1 CEE socket 32A, 400V, 5p
- 1 CEE socket 63A, 400V, 5p
- 1 double data socket RJ45 CAT6a IP55

Fuse:

- 4 C-type MCBs 16A, 1p
- 1 C-type MCB 16A, 3p
- 1 C-type MCB 32A, 3p
- 1 C-type MCB 63A, 3p
- 1 RCCB 63/0.03A, 4p

Cable entry at top and bottom:

each with 2x M20, 2x M40

Connection option:

for 2 cables up to 5 x 25 mm²



Ref. no. **89148**

Components:

- 6 domestic sockets 16A, 230V (type F - German standard)
- 1 CEE socket 16A, 400V, 5p
- 1 CEE socket 32A, 400V, 5p
- 1 CEE socket 63A, 400V, 5p

Fuse:

- 3 Neozed D01, 1p
- 1 Neozed D01, 3p
- 1 Neozed D02, 3p
- 1 RCCB 63/0.03A, 4p

Cable entry at top and bottom:

each with 1x M12, 1x M20, 2x M40

Connection option:

for 2 cables up to 5 x 25 mm²



Ref. no. **89987**

Components:

- 10 domestic sockets 16A, 230V (type F - German standard)
- 1 CEE socket 16A, 400V, 5p
- 1 CEE socket 32A, 400V, 5p

Fuse:

- 10 C-type MCBs 16A, 1p
- 1 C-type MCB 16A, 3p
- 1 C-type MCB 32A, 3p
- 1 RCCB 63/0.03A, 4p

Cable entry at top and bottom:

each with 1x M12, 1x M20, 2x M40

Connection option:

for 2 cables up to 5 x 25 mm²



Technical information

- Wired ready for connection
- Protection degree IP67
- All distributors comply with the DIN EN 61439 / IEC 61439

- Housing made of high-grade, impact-resistant plastic
- Top and bottom can be sealed together
- With external and internal fastening
- Permanently attached cover screws
- Top section straight, CEE sockets angled
- All CEE sockets with screwless, maintenance-free QUICK-CONNECT technology
- Colours: bottom - black, top - electro-grey (housing top optionally available in the colours yellow, red or blue)

Ref. no. **890919**

Components:

2 domestic sockets 16A, 230V
(type F - German standard)

Cable entry at top and bottom:
each with 1x M12, 1x M20, 2x M25

Connection option:
for 1 cable up to 3 x 4 mm²



Ref. no. **890920**

Components:

1 domestic socket 16A, 230V
(type F - German standard)
1 CEE socket 16A, 400V, 5p

Cable entry at top and bottom:
each with 1x M12, 1x M20, 2x M25

Connection option:
for 1 cable up to 5 x 4 mm²



Ref. no. **890921**

Components:

1 domestic socket 16A, 230V
(type F - German standard)
1 CEE socket 16A, 400V, 5p

Fuse:

1 C-type MCB 16A, 1p
1 C-type MCB 16A, 3p
1 RCCB 40/0.03A, 4p

Cable entry at top and bottom:
each with 1x M12, 1x M20, 2x M40

Connection option:
for 2 cables up to 5 x 25 mm²



Ref. no. **890922**

Components:

1 domestic socket 16A, 230V
(type F - German standard)
1 CEE socket 32A, 400V, 5p

Fuse:

1 C-type MCB 16A, 1p
1 C-type MCB 32A, 3p
1 RCCB 40/0.03A, 4p

Cable entry at top and bottom:
each with 1x M12, 1x M20, 2x M40

Connection option:
for 2 cables up to 5 x 25 mm²



Ref. no. **890923**

Components:

2 domestic sockets 16A, 230V
(type F - German standard)
1 CEE socket 16A, 400V, 5p
1 CEE socket 32A, 400V, 5p

Fuse:

2 C-type MCBs 16A, 1p
1 C-type MCB 16A, 3p
1 RCCB 40/0.03A, 4p

Cable entry at top and bottom:
each with 1x M12, 1x M20, 2x M40

Connection option:
for 2 cables up to 5 x 25 mm²



Ref. no. **890924**

Components:

2 domestic sockets 16A, 230V
(type F - German standard)
1 CEE socket 16A, 400V, 5p
1 CEE socket 32A, 400V, 5p

Fuse:

2 C-type MCBs 16A, 1p
1 C-type MCB 16A, 3p
1 C-type MCB 32A, 3p

Cable entry at top and bottom:
each with 1x M12, 1x M20, 2x M40

Connection option:
for 2 cables up to 5 x 25 mm²



Technical information

- Wired ready for connection
- Protection degree IP67
- All distributors comply with the DIN EN 61439 / IEC 61439

Ref. no. **890925**

Components:

3 domestic sockets 16A, 230V
(type F - German standard)
1 CEE socket 16A, 400V, 5p

Fuse:

3 C-type MCBs 16A, 1p
1 C-type MCB 16A, 3p
1 RCCB 40/0.03A, 4p

Cable entry at top and bottom:

each with 1x M12, 1x M20, 2x M40

Connection option:

for 2 cables up to 5 x 25 mm²



Ref. no. **890926**

Components:

3 domestic sockets 16A, 230V
(type F - German standard)
1 CEE socket 32A, 400V, 5p

Fuse:

3 C-type MCBs 16A, 1p
1 C-type MCB 32A, 3p
1 RCCB 40/0.03A, 4p

Cable entry at top and bottom:

each with 1x M12, 1x M20, 2x M40

Connection option:

for 2 cables up to 5 x 25 mm²



Ref. no. **890927**

Components:

2 domestic sockets 16A, 230V
(type F - German standard)
2 CEE sockets 16A, 400V, 5p

Fuse:

2 C-type MCBs 16A, 1p
2 C-type MCBs 16A, 3p

Cable entry at top and bottom:

each with 1x M12, 1x M20, 2x M40

Connection option:

for 2 cables up to 5 x 25 mm²



Ref. no. **890928**

Components:

2 domestic sockets 16A, 230V
(type F - German standard)
2 CEE sockets 32A, 400V, 5p

Fuse:

2 C-type MCBs 16A, 1p
2 C-type MCBs 32A, 3p

Cable entry at top and bottom:

each with 1x M12, 1x M20, 2x M40

Connection option:

for 2 cables up to 5 x 25 mm²



Ref. no. **890929**

Components:

2 domestic sockets 16A, 230V
(type F - German standard)
1 CEE socket 16A, 400V, 5p
1 CEE socket 32A, 400V, 5p

Fuse:

2 C-type MCBs 16A, 1p
1 C-type MCB 16A, 3p
1 C-type MCB 32A, 3p
1 RCCB 40/0.03A, 4p

Cable entry at top and bottom:

each with 1x M12, 1x M20, 2x M40

Connection option:

for 2 cables up to 5 x 25 mm²



Ref. no. **890930**

Components:

2 domestic sockets 16A, 230V
(type F - German standard)
1 CEE socket 16A, 400V, 5p
1 CEE socket 32A, 400V, 5p

Fuse:

2 C-type MCBs 16A, 1p
1 C-type MCB 16A, 3p
1 C-type MCB 32A, 3p
1 RCCB 63/0.03A, 4p

Cable entry at top and bottom:

each with 1x M12, 1x M20, 2x M40

Connection option:

for 2 cables up to 5 x 25 mm²



Ref. no. **890931**

Components:

3 domestic sockets 16A, 230V
(type F - German standard)
1 CEE socket 16A, 400V, 5p
1 CEE socket 32A, 400V, 5p

Fuse:

3 C-type MCBs 16A, 1p
1 C-type MCB 16A, 3p
1 C-type MCB 32A, 3p
1 RCCB 63/0.03A, 4p

Cable entry at top and bottom:

each with 1x M12, 1x M20, 2x M40

Connection option:

for 2 cables up to 5 x 25 mm²



Ref. no. **890932**

Components:

2 domestic sockets 16A, 230V
(type F - German standard)
2 CEE sockets 16A, 400V, 5p

Fuse:

2 C-type MCBs 16A, 1p
2 C-type MCBs 16A, 3p
1 RCCB 40/0.03A, 4p

Cable entry at top and bottom:

each with 1x M12, 1x M20, 2x M40

Connection option:

for 2 cables up to 5 x 25 mm²



Technical information

- Wired ready for connection
- Protection degree IP67
- All distributors comply with the DIN EN 61439 / IEC 61439

Ref. no. **890933**

Components:

2 domestic sockets 16A, 230V
(type F - German standard)
2 CEE sockets 32A, 400V, 5p

Fuse:

2 C-type MCBs 16A, 1p
2 C-type MCBs 32A, 3p
1 RCCB 63/0.03A, 4p

Cable entry at top and bottom:

each with 1x M12, 1x M20, 2x M40

Connection option:

for 2 cables up to 5 x 25 mm²



Ref. no. **890934**

Components:

3 domestic sockets 16A, 230V
(type F - German standard)
2 CEE sockets 16A, 400V, 5p

Fuse:

3 C-type MCBs 16A, 1p
2 C-type MCBs 16A, 3p
1 RCCB 40/0.03A, 4p

Cable entry at top and bottom:

each with 1x M12, 1x M20, 2x M40

Connection option:

for 2 cables up to 5 x 25 mm²



Ref. no. **890935**

Components:

2 domestic sockets 16A, 230V
(type F - German standard)
1 CEE socket 16A, 400V, 5p
1 CEE socket 32A, 400V, 5p
1 CEE socket 63A, 400V, 5p

Fuse:

2 C-type MCBs 16A, 1p
1 C-type MCB 16A, 3p
1 C-type MCB 32A, 3p
1 RCCB 63/0.03A, 4p

Cable entry at top and bottom:

each with 1x M12, 1x M20, 2x M40

Connection option:

for 2 cables up to 5 x 25 mm²



Ref. no. **890936**

Components:

3 domestic sockets 16A, 230V
(type F - German standard)
2 CEE sockets 16A, 400V, 5p
1 CEE socket 32A, 400V, 5p

Fuse:

3 C-type MCBs 16A, 1p
2 C-type MCBs 16A, 3p
1 C-type MCB 32A, 3p
1 RCCB 63/0.03A, 4p

Cable entry at top and bottom:

each with 1x M12, 1x M20, 2x M40

Connection option:

for 2 cables up to 5 x 25 mm²



Ref. no. **890937**

Components:

3 domestic sockets 16A, 230V
(type F - German standard)
1 CEE socket 16A, 400V, 5p
1 CEE socket 32A, 400V, 5p
1 CEE socket 63A, 400V, 5p

Fuse:

3 C-type MCBs 16A, 1p
1 C-type MCB 16A, 3p
1 C-type MCB 32A, 3p
1 RCCB 63/0.03A, 4p

Cable entry at top and bottom:

each with 1x M12, 1x M20, 2x M40

Connection option:

for 2 cables up to 5 x 25 mm²



Ref. no. **890938**

Components:

3 domestic sockets 16A, 230V
(type F - German standard)
1 CEE socket 16A, 400V, 5p
2 CEE sockets 32A, 400V, 5p

Fuse:

3 C-type MCBs 16A, 1p
1 C-type MCB 16A, 3p
2 C-type MCBs 32A, 3p
1 RCCB 63/0.03A, 4p

Cable entry at top and bottom:

each with 1x M12, 1x M20, 2x M40

Connection option:

for 2 cables up to 5 x 25 mm²



Ref. no. **890939**

Components:

2 domestic sockets 16A, 230V
(type F - German standard)
2 CEE sockets 16A, 400V, 5p
1 CEE socket 32A, 400V, 5p
1 CEE socket 63A, 400V, 5p

Fuse:

1 C-type MCB 16A, 1p
2 C-type MCBs 16A, 3p
1 C-type MCB 32A, 3p
1 RCCB 63/0.03A, 4p

Cable entry at top and bottom:

each with 1x M12, 1x M20, 2x M40

Connection option:

for 2 cables up to 5 x 25 mm²



Ref. no. **896294**

Components:

2 domestic sockets 16A, 230V
(type F - German standard)
1 CEE socket 16A, 400V, 5p
1 CEE socket 32A, 400V, 5p
3 RJ45 CAT6a data sockets

Fuse:

2 C-type MCBs 16A, 1p
1 C-type MCB 16A, 3p
1 C-type MCB 32A, 3p
1 RCCB 63/0.03A, 4p

Cable entry at top and bottom:

each with 3x M20, 2x M40

Connection option:

for 2 cables up to 5 x 25 mm²



1

2

3

4

5

6

7

Technical information

- Wired ready for connection
- Protection degree IP54
- All distributors comply with the DIN EN 61439 / IEC 61439

VARIABOX extension – network socket:

- Perfect optical integration in the existing system
- Optionally equipped with RJ45, HDMI or USB
- Various data technology inserts available
- With protection against contact
- Protection degree IP54
- Greater flexibility in the Variabox system landscape
- Can be closed with the plugs plugged in, optionally lockable
- With labelling fields



Detailed view of the network socket.

Ref. no. **893419**

Components:

2 RJ45 CAT6a below operating window, can be closed with the plugs plugged in

Cable entry:

2 x M25 top closed
1 x M25 bottom
1 x cable gland M25 with multiple sealing insert 2 x 8 mm bottom



Ref. no. **896346**

Components:

2 RJ45 CAT6a below operating window, can be closed with the plugs plugged in

Cable entry:

1 x M12, 1 x M20, 2 x M25 top
1 x M12, 1 x M20 bottom
2 x cable gland M25 with multiple sealing insert 2 x 8 mm bottom



Ref. no. **895347**

Components:

2 domestic sockets 16A, 230V (type F - German standard)
2 RJ45 CAT6a below operating window, can be closed with the plugs plugged in

Cable entry:

1 x cable gland M20 top
1 x cable gland M25 with multiple sealing insert 2 x 8 mm top
1 x M20, 1 x M25 bottom



Ref. no. **896347**

Components:

2 domestic sockets 16A, 230V (type F - German standard)
4 RJ45 CAT6a below operating window, can be closed with the plugs plugged in

Cable entry:

1 x cable gland M20 top
1 x cable gland M32 with multiple sealing insert 4 x 8 mm top
1 x M20, 1 x M32 bottom



Connection option:

for 1 cable up to 3 x 6 mm²

Connection option:

for 1 cable up to 3 x 6 mm²

Ref. no. **896329**

Components:

2 domestic sockets 16A, 230V (type F - German standard)
2 RJ45 CAT6a below operating window, can be closed with the plugs plugged in

Cable entry:

1 x M12, 1 x M20 top
1 x cable gland M25
1 x cable gland M25 with multiple sealing insert 2 x 8 mm bottom
1 x M12, 1 x M20, 2 x M25 unten



Ref. no. **896400**

Components:

2 domestic sockets 16A, 230V (type F - German standard)
2 RJ45 CAT6a below operating window, can be closed with the plugs plugged in

Fuse:

2 C-type MCBs 16A, 1p
1 RCCB 40/0.03A, 4p

Cable entry:

1 x M20, 1 x M25 top closed
1 x cable gland M20 bottom
1 x cable gland M25 with multiple sealing insert 2 x 8 mm bottom



Connection option:

for 1 cable up to 3 x 6 mm²

Surface mounting network distributor

- Housing made of high-grade, impact-resistant plastic
- Size 140x100x90mm
- With network socket for max. 4 data modules
- With 2x TSS Multi M25

Ref. no. **581338**



Network socket

- For max. 4 data modules
- With 4 blank cover
- With protection cover plate
- Can be closed with the plugs plugged in, optionally lockable

Ref. no. **581276**



Data module RJ45 CAT 6a

- KeyStone module
- 10 Gigabit-Ethernet
- Insulation displacement contact

Manufacturer	Ref. no.
BTR	50003186
R&M	50002819
AMP	50003206
Dätwyler	50003208
Corning	50003209
3M	50003210
Telegärtner	50003211



Data module USB 2.0 A/A

- KeyStone module
- Colour: black

Ref. no. **50003218**



Data module USB 2.0 A/B

- KeyStone module
- Colour: white

Ref. no. **50003205**



Data module HDMI

- HDMI double socket
- KeyStone module
- Gold plated contacts
- Colour: white

Ref. no. **50003203**



KeyStone Blank Cover

- Colour: white

Ref. no. **20001402**



Variabox extension – switching bar:

- Perfect optical integration in the existing system
- User-friendly arrangement in the case of multiple units
- Mechanical double-interlocking
- Can be locked in the 0-position
- Nickel plated contacts
- High-temperature-resistant contact carriers
- Greater flexibility in the Variabox system landscape
- Suitable for harsh environmental conditions
- Versions in all voltages and frequencies from 16A 3-pole to 32A 5-pole
- Protection degrees IP44, IP54 and IP67



Detailed view of switched interlocked flange plate.

Ref. no. **896373**

Components:

1 CEE socket 16A, 400V, 5p, IP44
 nickel plated contacts, with mechanical interlocking, lockable in 0-position

Fuse:

1 C-type MCB 16A, 3p
 1 RCCB 40/0.03A, 4p

Cable entry at top and bottom:

each with 1x M12, 1x M20, 2x M40

Connection option:

for 2 cables up to 5 x 25 mm²



Ref. no. **896285**

Components:

1 CEE socket 16A, 400V, 5p, IP67
 nickel plated contacts, with mechanical interlocking, lockable in 0-position

Fuse:

1 C-type MCB 16A, 3p
 1 RCCB 40/0.03A, 4p

Cable entry at top and bottom:

each with 1x M12, 1x M20, 2x M40

Connection option:

for 2 cables up to 5 x 25 mm²



Ref. no. **896374**

Components:

1 CEE socket 32A, 400V, 5p, IP44
 nickel plated contacts, with mechanical interlocking, lockable in 0-position

Fuse:

1 C-type MCB 32A, 3p
 1 RCCB 40/0.03A, 4p

Cable entry at top and bottom:

each with 1x M12, 1x M20, 2x M40

Connection option:

for 2 cables up to 5 x 25 mm²



Ref. no. **896368**

Components:

1 CEE socket 32A, 400V, 5p, IP67
 nickel plated contacts, with mechanical interlocking, lockable in 0-position

Fuse:

1 C-type MCB 32A, 3p
 1 RCCB 40/0.03A, 4p

Cable entry at top and bottom:

each with 1x M12, 1x M20, 2x M40

Connection option:

for 2 cables up to 5 x 25 mm²



Ref. no. **896376**

Components:

2 CEE sockets 16A, 400V, 5p, IP44
 nickel plated contacts, with mechanical interlocking, lockable in 0-position

Fuse:

2 C-type MCBs 16A, 3p
 1 RCCB 40/0.03A, 4p

Cable entry at top and bottom:

each with 1x M12, 1x M20, 2x M40

Connection option:

for 2 cables up to 5 x 25 mm²



Ref. no. **896377**

Components:

2 CEE sockets 16A, 400V, 5p, IP67
 nickel plated contacts, with mechanical interlocking, lockable in 0-position

Fuse:

2 C-type MCBs 16A, 3p
 1 RCCB 40/0.03A, 4p

Cable entry at top and bottom:

each with 1x M12, 1x M20, 2x M40

Connection option:

for 2 cables up to 5 x 25 mm²



Technical information

- Ready wired for installation

- Dimension of enclosure: 211 x 116 mm
- Ready wired for installation
- Enclosure made of high-grade, impact-resistant plastic
- Small, compact design
- Variable configuration

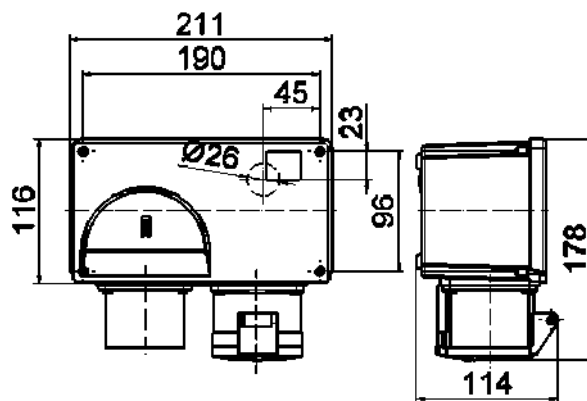

30 MB 173

Ref. no. **591**

Components:

1 CEE socket 16A, 400V, 5p

Cable entry:

1 CEE inlet 16A, 400V, 5p



Ref. no. **592**

Components:

1 CEE socket 32A, 400V, 5p

Cable entry:

1 CEE inlet 32A, 400V, 5p







We live in a fast-moving time. It is also frequently necessary to make modifications to power distribution systems. Power distributors used in industrial buildings, production facilities, laboratories, harbour docks, markets, tunnel, road construction sites and many other locations therefore frequently need to be adapted to their external conditions. In extreme applications, these distribution systems are often exposed to very harsh environmental conditions. That's where the MODBOX® is the ideal solution. The patented MODBOX® Rubber Distributor Series combines all the demands placed on power distributors up to a maximum degree of protection of IP67.

When it comes to toughness, the MODBOX® leaves no wish unfulfilled. The material properties of the MODBOX® are unique: its robustness and resistance to ageing, temperature, oil and acid are unbeatable characteristics that can not be achieved by other

distributor housings. The MODBOX® is, of course, also fully insulated, UV-resistant and halogen-free as well as flame-resistant and self-extinguishing.

The truly innovative enclosure design allows existing installations to be adapted quickly. Order separation attachments are provided in the enclosure. This makes it easier to install strong-current and weak-current systems.

An outstanding feature is that MODBOX® units can be easily connected next to each as modules without any modifications needing to be made to the basic installation.

The MODBOX® is freely configurable. Four openings in the side of the MODBOX® allow modules to be added in any direction. Another feature are the yellow connecting and end corners. To further improve safety, the luminous end corners (luminescence time up to 7 hours) are recommended.

Technical Data

- Maximum Protection degree IP67
- MODBOX MIDI with user-friendly OTC operating window
- Modular expansion on all 4 sides possible
- Yellow end corners for increased safety
- Cover available on request with or without rain roof
- Hard Rubber mixture with hardness grade of 99 shore
- Corners and stability framework are made of cured glass-fibre-reinforced Polyamide
- Outer corners luminous on request
- Fully insulated

Material properties

- Impact-resistant
- UV-resistant
- Halogen-free
- Resistant to ageing, temperature, oil and acid
- Excellent resistance to chemicals
- Flame-resistant, self-extinguishing



Technical information

- Wired ready for connection
- Protection degree IP44
- All distributors comply with the DIN EN 61439 / IEC 61439

- Enclosure made of high-quality, impact-resistant solid rubber
- User-friendly OTC operating window
- Modular extension
- Hardness grade of 99 shore
- Resistant to ageing, temperature, oil and acid
- Excellent resistance to chemicals
- Flame-resistant, self-extinguishing
- Top section straight, CEE sockets angled
- All CEE sockets with screwless, maintenance-free QUICK-CONNECT technology
- Black top and bottom section with yellow end corners

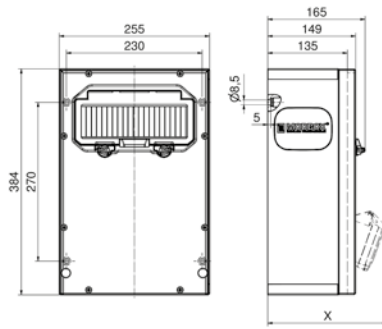

Depth X (mm)

Component	IP44	IP67
OTC operating window	165	165
Domestic socket	152	195
CEE 16A 3p	190	190
CEE 16A 4p	194	192
CEE 16A 5p	197	195
CEE 32A 3p / 4p	201	203
CEE 32A 5p	203	204
CEE 63A 3p / 4p / 5p	219	221

30 MB 218

Ref. no. **5401882**

Components:

3 Domestic sockets 16A, 230V ~
(type F - German standard)

Fuse:

3 C-type MCBs 16A, 1p
1 RCCB 40/0.03A, 4p

Cable entry at top and bottom:

each with 2x M40

Connection option:

for 2 cables up to 5 x 25 mm²

with RCCB B type: 5402775



Ref. no. **5401884**

Components:

6 Domestic sockets 16A, 230V ~
(type F - German standard)

Fuse:

6 C-type MCBs 16A, 1p
1 RCCB 40/0.03A, 4p

Cable entry at top and bottom:

each with 2x M40

Connection option:

for 2 cables up to 5 x 25 mm²

with RCCB B type: 5402776



Ref. no. **5401886**

Components:

2 Domestic sockets 16A, 230V ~
(type F - German standard)
1 CEE socket 16A, 400V, 5p

Fuse:

2 C-type MCBs 16A, 1p
1 C-type MCB 16A, 3p
1 RCCB 40/0.03A, 4p

Cable entry at top and bottom:

each with 2x M40

Connection option:

for 2 cables up to 5 x 25 mm²

with RCCB B type: 5402510



Ref. no. **5401892**

Components:

2 Domestic sockets 16A, 230V ~
(type F - German standard)
1 CEE socket 16A, 400V, 5p
1 CEE socket 32A, 400V, 5p

Fuse:

2 C-type MCBs 16A, 1p
1 C-type MCB 16A, 3p
1 RCCB 40/0.03A, 4p

Cable entry at top and bottom:

each with 2x M40

Connection option:

for 2 cables up to 5 x 25 mm²

with RCCB B type: 5402777



Ref. no. **5401894**

Components:

3 Domestic sockets 16A, 230V ~
(type F - German standard)
2 CEE sockets 16A, 400V, 5p

Fuse:

3 C-type MCBs 16A, 1p
2 C-type MCBs 16A, 3p

Cable entry at top and bottom:

each with 2x M40

Connection option:

for 2 cables up to 5 x 25 mm²



Ref. no. **5402794**

Components:

2 Domestic sockets 16A, 230V ~
(type F - German standard)
1 CEE socket 16A, 400V, 5p
1 CEE socket 32A, 400V, 5p
1 double data socket RJ45 CAT6a IP55

Fuse:

2 C-type MCBs 16A, 1p
1 C-type MCB 16A, 3p
1 RCCB 40/0.03A, 4p

Cable entry at top and bottom:

each with 2 x M20 and 2x M32

Connection option:

for 2 cables up to 5 x 25 mm²

with RCCB B type: 5402797



Technical information

- Wired ready for connection
- Protection degree IP44
- All distributors comply with the DIN EN 61439 / IEC 61439

- Enclosure made of high-quality, impact-resistant solid rubber
- Modular extension
- Hardness grade of 99 shore
- Resistant to ageing, temperature, oil and acid
- Excellent resistance to chemicals
- Flame-resistant, self-extinguishing
- Top section straight, CEE sockets angled
- All CEE sockets with screwless, maintenance-free QUICK-CONNECT technology
- Black top and bottom section with yellow end corners

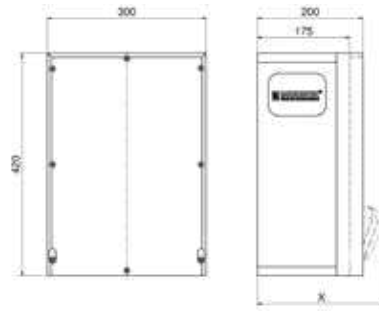

Depth X (mm)

Component	IP44	IP67
Domestic socket	192	235
CEE 16A 3p	230	230
CEE 16A 4p	234	232
CEE 16A 5p	237	235
CEE 32A 3p / 4p	241	243
CEE 32A 5p	243	244
CEE 63A 3p / 4p / 5p	259	261

13 MB 109

Ref. no. **5401455**

Components:

3 Domestic sockets 16A, 230V ~
(type F - German standard)
2 CEE sockets 16A, 400V, 5p

Fuse:

3 C-type MCBs 16A, 1p
2 C-type MCBs 16A, 3p
1 RCCB 40/0.03A, 4p

Cable entry at top and bottom:
each with 2x M40

Connection option:

for 2 cables up to 5 x 25 mm²

with RCCB B type: 5402778



Ref. no. **5401567**

Components:

3 Domestic sockets 16A, 230V ~
(type F - German standard)
2 CEE sockets 32A, 400V, 5p

Fuse:

3 C-type MCBs 16A, 1p
2 C-type MCBs 32A, 3p
1 RCCB 63/0.03A, 4p

Cable entry at top and bottom:
each with 2x M40

Connection option:

for 2 cables up to 5 x 25 mm²

with RCCB B type: 5402779



Ref. no. **5401343**

Components:

3 Domestic sockets 16A, 230V ~
(type F - German standard)
1 CEE socket 16A, 400V, 5p
1 CEE socket 32A, 400V, 5p

Fuse:

3 C-type MCBs 16A, 1p
1 C-type MCB 16A, 3p
1 C-type MCB 32A, 3p
1 RCCB 40/0.03A, 4p

Cable entry at top and bottom:
each with 2x M40

Connection option:

for 2 cables up to 5 x 16 mm²

with RCCB B type: 5402438



Ref. no. **5401668**

Components:

3 Domestic sockets 16A, 230V ~
(type F - German standard)
1 CEE socket 16A, 400V, 5p
1 CEE socket 32A, 400V, 5p

Fuse:

3 Neozed D01, 1p
1 Neozed D01, 3p
1 RCCB 40/0.03A, 4p

Cable entry at top and bottom:
each with 2x M40

Connection option:

for 2 cables up to 5 x 25 mm²

with RCCB B type: 5402780



Ref. no. **5401662**

Components:

3 Domestic sockets 16A, 230V ~
(type F - German standard)
1 CEE socket 16A, 400V, 5p
1 CEE socket 32A, 400V, 5p

Fuse:

3 Neozed D01, 1p
1 Neozed D01, 3p
1 Neozed D02, 3p

Cable entry at top and bottom:
each with 2x M40

Connection option:

for 2 cables up to 5 x 25 mm²



Ref. no. **5402044**

Components:

2 Domestic sockets 16A, 230V ~
(type F - German standard)
2 CEE sockets 32A, 400V, 5p

Fuse:

2 C-type MCBs 16A, 1p
2 C-type MCBs 32A, 3p
1 RCCB 63/0.03A, 4p

Cable entry at top and bottom:
each with 2x M40

Connection option:

for 2 cables up to 5 x 25 mm²

with RCCB B type: 5402781



Technical information

- Wired ready for connection
- Protection degree IP44
- All distributors comply with the DIN EN 61439 / IEC 61439

Ref. no. **5401302**

Components:

- 2 Domestic sockets 16A, 230V ~ (type F - German standard)
- 1 CEE socket 16A, 400V, 5p
- 1 CEE socket 32A, 400V, 5p

Fuse:

- 2 C-type MCBs 16A, 1p
- 1 C-type MCB 16A, 3p
- 1 C-type MCB 32A, 3p
- 1 RCCB 40/0.03A, 4p

Cable entry at top and bottom:

each with 2x M40

Connection option:

for 2 cables up to 5 x 25 mm²

with RCCB B type: 5402511



Ref. no. **5402046**

Components:

- 3 Domestic sockets 16A, 230V ~ (type F - German standard)
- 1 CEE socket 16A, 400V, 5p
- 1 CEE socket 16A, 400V, 5p

Fuse:

- 3 C-type MCBs 16A, 1p
- 1 C-type MCB 16A, 1p
- 1 C-type MCB 16A, 3p
- 1 RCCB 40/0.03A, 4p

Cable entry at top and bottom:

each with 2x M40

Connection option:

for 2 cables up to 5 x 25 mm²

with RCCB B type: 5402782



Ref. no. **5401453**

Components:

- 4 Domestic sockets 16A, 230V ~ (type F - German standard)
- 1 CEE socket 16A, 400V, 5p
- 1 CEE socket 32A, 400V, 5p

Fuse:

- 2 C-type MCBs 16A, 1p
- 1 C-type MCB 16A, 3p
- 1 C-type MCB 32A, 3p
- 1 RCCB 63/0.03A, 4p

Cable entry at top and bottom:

each with 2x M40

Connection option:

for 2 cables up to 5 x 25 mm²

with RCCB B type: 5402783



Ref. no. **5402795**

Components:

- 2 Domestic sockets 16A, 230V ~ (type F - German standard)
- 1 CEE socket 16A, 400V, 5p
- 1 CEE socket 32A, 400V, 5p
- 2 RJ45 CAT6a below operating window

Fuse:

- 2 C-type MCBs 16A, 1p
- 1 C-type MCB 16A, 3p
- 1 C-type MCB 32A, 3p
- 1 RCCB 40/0.03A, 4p

Cable entry at top and bottom:

each with 2x M20 and 2x M40

Connection option:

for 2 cables up to 5 x 25 mm²

with RCCB B type: 5402796



Ref. no. **5402047**

Components:

- 4 Domestic sockets 16A, 230V ~ (type F - German standard)
- 1 CEE socket 16A, 400V, 5p
- 1 CEE socket 32A, 400V, 5p

Fuse:

- 4 C-type MCBs 16A, 1p
- 1 C-type MCB 16A, 3p
- 1 C-type MCB 32A, 3p

Cable entry at top and bottom:

each with 2x M40

Connection option:

for 2 cables up to 5 x 25 mm²



Ref. no. **5401274**

Components:

- 2 Domestic sockets 16A, 230V ~ (type F - German standard)
- 1 CEE socket 16A, 400V, 5p
- 1 CEE socket 32A, 400V, 5p

Fuse:

- 2 C-type MCBs 16A, 1p
- 1 C-type MCB 16A, 3p
- 1 C-type MCB 32A, 3p
- 1 RCCB 63/0.03A, 4p

Cable entry at top and bottom:

each with 2x M40

Connection option:

for 2 cables up to 5 x 25 mm²

with RCCB B type: 5402784



Ref. no. **5402059**

Components:

- 2 Domestic sockets 16A, 230V ~ (type F - German standard)
- 1 CEE socket 16A, 400V, 5p
- 1 CEE socket 32A, 400V, 5p
- 1 double data socket RJ45 CAT6a IP55

Fuse:

- 2 C-type MCBs 16A, 1p
- 1 C-type MCB 16A, 3p
- 1 C-type MCB 32A, 3p
- 1 RCCB 40/0.03A, 4p

Cable entry at top and bottom:

each with 2x M20, 2x M40

Connection option:

for 2 cables up to 5 x 25 mm²

with RCCB B type: 5402785



Ref. no. **5402060**

Components:

- 3 Domestic sockets 16A, 230V ~ (type F - German standard)
- 1 CEE socket 16A, 400V, 5p
- 1 CEE socket 32A, 400V, 5p
- 1 double data socket RJ45 CAT6a IP55

Fuse:

- 3 C-type MCBs 16A, 1p
- 1 C-type MCB 16A, 3p
- 1 C-type MCB 32A, 3p
- 1 RCCB 63/0.03A, 4p

Cable entry at top and bottom:

each with 2x M20, 2x M40

Connection option:

for 2 cables up to 5 x 16 mm²

with RCCB B type: 5402786



Technical information

- Wired ready for connection
- Protection degree IP67
- All distributors comply with the DIN EN 61439 / IEC 61439

Ref. no. **5402159**

Components:

4 Domestic sockets 16A, 230V ~
(type F - German standard)

Fuse:

4 C-type MCBs 16A, 1p
1 RCCB 40/0.03A, 4p

Cable entry at bottom:

1x M12, 2x M40

Connection option:

for 2 cables up to 5 x 25 mm²

with RCCB B type: 5402787



Ref. no. **5402160**

Components:

3 Domestic sockets 16A, 230V ~
(type F - German standard)
1 CEE socket 16A, 400V, 5p

Fuse:

3 C-type MCBs 16A, 1p
1 C-type MCB 16A, 3p
1 RCCB 40/0.03A, 4p

Cable entry at bottom:

1x M12, 2x M40

Connection option:

for 2 cables up to 5 x 25 mm²

with RCCB B type: 5402788



Ref. no. **5402161**

Components:

2 Domestic sockets 16A, 230V ~
(type F - German standard)
2 CEE sockets 16A, 400V, 5p

Fuse:

2 C-type MCBs 16A, 1p
2 C-type MCBs 16A, 3p
1 RCCB 40/0.03A, 4p

Cable entry at bottom:

1x M12, 2x M40

Connection option:

for 2 cables up to 5 x 25 mm²

with RCCB B type: 5402789



Ref. no. **5402162**

Components:

2 Domestic sockets 16A, 230V ~
(type F - German standard)
1 CEE socket 16A, 400V, 5p
1 CEE socket 32A, 400V, 5p

Fuse:

2 C-type MCBs 16A, 1p
1 C-type MCB 16A, 3p
1 C-type MCB 32A, 3p
1 RCCB 40/0.03A, 4p

Cable entry at bottom:

1x M12, 2x M40

Connection option:

for 2 cables up to 5 x 25 mm²

with RCCB B type: 5402618



Ref. no. **5402163**

Components:

2 Domestic sockets 16A, 230V ~
(type F - German standard)
1 CEE socket 16A, 400V, 5p
1 CEE socket 32A, 400V, 5p

Fuse:

2 C-type MCBs 16A, 1p
1 C-type MCB 16A, 3p
1 C-type MCB 32A, 3p
1 RCCB 63/0.03A, 4p

Cable entry at bottom:

1x M12, 2x M40

Connection option:

for 2 cables up to 5 x 25 mm²

with RCCB B type: 5402790



Ref. no. **5402164**

Components:

2 Domestic sockets 16A, 230V ~
(type F - German standard)
2 CEE sockets 32A, 400V, 5p

Fuse:

2 C-type MCBs 16A, 1p
2 C-type MCBs 32A, 3p
1 RCCB 63/0.03A, 4p

Cable entry at bottom:

1x M12, 2x M40

Connection option:

for 2 cables up to 5 x 25 mm²

with RCCB B type: 5402791



Ref. no. **5402165**

Components:

3 Domestic sockets 16A, 230V ~
(type F - German standard)
1 CEE socket 16A, 400V, 5p
1 CEE socket 32A, 400V, 5p

Fuse:

3 C-type MCBs 16A, 1p
1 C-type MCB 16A, 3p
1 C-type MCB 32A, 3p
1 RCCB 63/0.03A, 4p

Cable entry at bottom:

1x M12, 2x M40

Connection option:

for 2 cables up to 5 x 25 mm²

with RCCB B type: 5402565



Ref. no. **5402166**

Components:

3 Domestic sockets 16A, 230V ~
(type F - German standard)
2 CEE sockets 16A, 400V, 5p

Fuse:

3 C-type MCBs 16A, 1p
2 C-type MCBs 16A, 3p
1 RCCB 40/0.03A, 4p

Cable entry at bottom:

1x M12, 2x M40

Connection option:

for 2 cables up to 5 x 25 mm²

with RCCB B type: 5402792



Combinations

Solid-Rubber distributor, surface mounting

Technical information

- Wired ready for connection
- Protection degree IP44
- All distributors comply with the DIN EN 61439 / IEC 61439

- Enclosure made of high-quality, impact-resistant solid rubber
- Space for up to 18 modules under operating window
- Hardness grade of 97 shore
- Hinged lid
- Resistant to ageing, temperature, oil and acid
- Flame-resistant, self-extinguishing
- All CEE sockets with screwless, maintenance-free QUICK-CONNECT technology

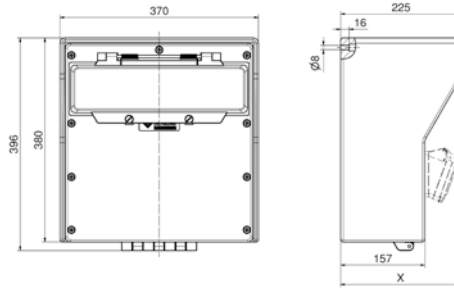

13 MB 117

Depth X (mm)

Component	IP44	IP67	Component	IP44	IP67
Domestic socket	172	215	CEE 32A 3p / 4p	221	223
CEE 16A 3p	210	210	CEE 32A 5p	223	224
CEE 16A 4p	214	212	CEE 63A 3p / 4p / 5p	239	241
CEE 16A 5p	217	215			

Ref. no. **5402049**

Components:

- 4 Domestic sockets 16A, 230V ~ (type F - German standard)
- 2 CEE sockets 16A, 400V, 5p
- 1 CEE socket 32A, 400V, 5p

Fuse:

- 4 C-type MCBs 16A, 1p
- 2 C-type MCBs 16A, 3p
- 1 C-type MCB 32A, 3p
- 1 RCCB 63/0.03A, 4p

Cable entry at top and bottom:
each with 2x M40

Connection option:
for 2 cables up to 5 x 25 mm²

with RCCB B type: 5402633



Ref. no. **5402050**

Components:

- 4 Domestic sockets 16A, 230V ~ (type F - German standard)
- 2 CEE sockets 16A, 400V, 5p
- 1 CEE socket 32A, 400V, 5p

Fuse:

- 4 C-type MCBs 16A, 1p
- 2 C-type MCBs 16A, 3p
- 1 C-type MCB 32A, 3p

Cable entry at top and bottom:
each with 2x M40

Connection option:
for 2 cables up to 5 x 25 mm²



Ref. no. **5402051**

Components:

- 2 Domestic sockets 16A, 230V ~ (type F - German standard)
- 1 CEE socket 16A, 400V, 5p
- 1 CEE socket 32A, 400V, 5p
- 1 CEE socket 63A, 400V, 5p

Fuse:

- 2 C-type MCBs 16A, 1p
- 1 C-type MCB 16A, 3p
- 1 C-type MCB 32A, 3p
- 1 Neozed D02, 3p
- 1 RCCB 63/0.03A, 4p

Cable entry at top and bottom:
each with 2x M40

Connection option:
for 2 cables up to 5 x 25 mm²



Ref. no. **5402052**

Components:

- 4 Domestic sockets 16A, 230V ~ (type F - German standard)
- 1 CEE socket 16A, 400V, 5p
- 1 CEE socket 32A, 400V, 5p
- 1 CEE socket 63A, 400V, 5p

Fuse:

- 4 C-type MCBs 16A, 1p
- 1 C-type MCB 16A, 3p
- 1 C-type MCB 32A, 3p
- 1 RCCB 63/0.03A, 4p

Cable entry at top and bottom:
each with 2x M40

Connection option:
for 2 cables up to 5 x 25 mm²

with RCCB B type: 5402634



Ref. no. **5402053**

Components:

- 4 Domestic sockets 16A, 230V ~ (type F - German standard)
- 1 CEE socket 16A, 400V, 5p
- 1 CEE socket 32A, 400V, 5p
- 1 CEE socket 63A, 400V, 5p

Fuse:

- 4 C-type MCBs 16A, 1p
- 1 C-type MCB 16A, 3p
- 1 C-type MCB 32A, 3p

Cable entry at top and bottom:
each with 2x M40

Connection option:
for 2 cables up to 5 x 25 mm²



Ref. no. **5402054**

Components:

- 2 Domestic sockets 16A, 230V ~ (type F - German standard)
- 1 CEE socket 16A, 400V, 5p
- 1 CEE socket 32A, 400V, 5p
- 1 CEE socket 63A, 400V, 5p

Fuse:

- 2 Neozed D01, 1p
- 1 Neozed D01, 3p
- 2 Neozed D02, 3p

Cable entry at top and bottom:
each with 2x M50

Connection option:
for 2 cables up to 5 x 25 mm²



Technical information

- Ready wired for installation

- Dimension of enclosure: 300 x 300 mm
- Enclosure made of high-quality V2A stainless steel
- Brushed surface
- Door with box lock and single profile cylinder
- Wall mounting brackets, supplied loose
- Brush seal prevents dirt and dust from entering when door is closed
- Lockable in connected state
- Outgoing cables can be guided out through brush-sealed opening on front side
- Easy access to operating elements

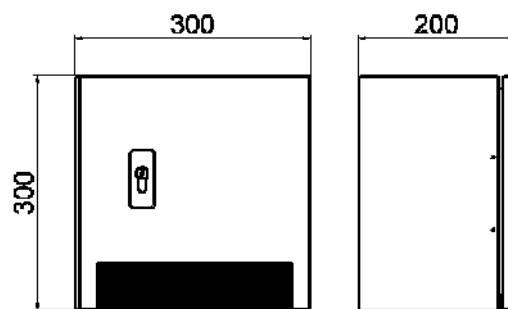

45 MB 50

Ref. no. **560967**

Components:

2 Domestic sockets 16A, 230V ~
(Type F - German standard)
1 CEE socket 16A, 400V, 5p

Cable entry at bottom:

1x M20, 1x M25, 1x M32

Connection option:

for 1 cable 3 x 4 mm² and
1 cable 5 x 4 mm²



Ref. no. **560508**

Components:

1 Domestic socket 16A, 230V ~
(Type F - German standard)
1 CEE socket 16A, 400V, 5p
1 CEE socket 32A, 400V, 5p

Cable entry at bottom:

1x M20, 1x M25, 1x M32

Connection option:

for 1 cable 3 x 4 mm²,
1 cable 5 x 4 mm² and
1 cable 5 x 6 mm²



- Dimension of enclosure: 500 x 420 mm
- Enclosure made of high-quality V2A stainless steel
- Brushed surface
- Door with box lock and single profile cylinder
- Wall mounting brackets, supplied loose
- Brush seal prevents dirt and dust from entering when door is closed
- Lockable in connected state
- Outgoing cables can be guided out through brush-sealed opening on front side
- Easy access to operating elements

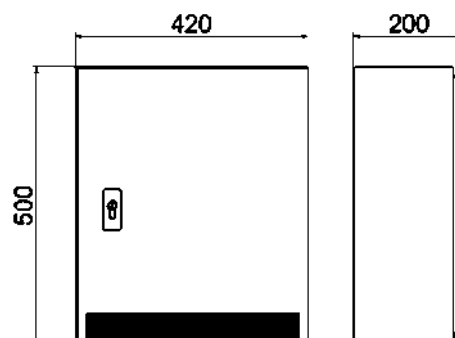

45 MB 17

Ref. no. **560384**

Components:

2 Domestic sockets 16A, 230V ~
(Type F - German standard)
1 CEE socket 16A, 400V, 5p
1 CEE socket 32A, 400V, 5p

Protection:

2 C-type MCBs 16A, 1p
1 C-type MCB 16A, 3p
1 C-type MCB 32A, 3p
1 RCCB 63/0.03A, 4p

Cable entry at bottom:

1x M25, 1x M32, 1x M40

Connection option:

for 2 cables up to 5 x 25 mm²



Ref. no. **562373**

Components:

2 Domestic sockets 16A, 230V ~
(Type F - German standard)
2 CEE sockets 16A, 400V, 5p

Protection:

2 C-type MCBs 16A, 1p
2 C-type MCBs 16A, 3p
1 RCCB 40/0.03A, 4p

Cable entry at bottom:

1x M25, 1x M32, 1x M40

Connection option:

for 2 cables up to 5 x 25 mm²



Combinations

Surface mounting cabinets

Technical information

- Ready wired for installation

- Dimension of enclosure: 700 x 500 mm
- Enclosure made of high-quality V2A stainless steel
- Brushed surface
- Door with box lock and single profile cylinder
- Wall mounting brackets, supplied loose
- Brush seal prevents dirt and dust from entering when door is closed
- Lockable in connected state
- Outgoing cables can be guided out through brush-sealed opening on front side
- Easy access to operating elements

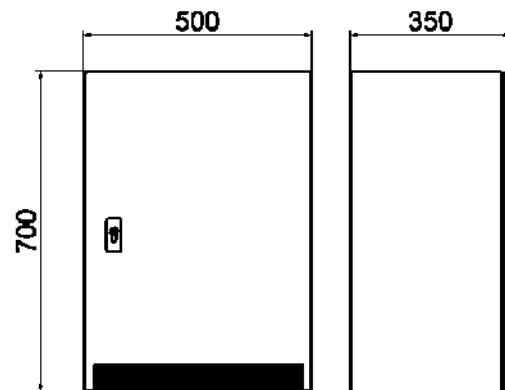

45 MB 45

Ref. no. **562374**

Components:

- 4 Domestic sockets 16A, 230V ~ (Type F - German standard)
- 1 CEE socket 16A, 400V, 5p
- 1 CEE socket 32A, 400V, 5p
- 1 CEE socket 63A, 400V, 5p

Protection:

- 4 C-type MCBs 16A, 1p
- 1 C-type MCB 16A, 3p
- 1 C-type MCB 32A, 3p
- 1 C-type MCB 63A, 3p
- 2 RCCB 63/0.03A, 4p
- 2 fuse bases D02, 3p

Cable entry at bottom:

- 2x M63

Connection option:

- for 2 cables up to 5 x 50 mm²



Ref. no. **562377**

Components:

- 4 Domestic sockets 16A, 230V ~ (Type F - German standard)
- 2 CEE sockets 16A, 400V, 5p
- 2 CEE sockets 32A, 400V, 5p

Protection:

- 4 C-type MCBs 16A, 1p
- 2 C-type MCBs 16A, 3p
- 2 C-type MCBs 32A, 3p
- 1 RCCB 63/0.03A, 4p

Cable entry at bottom:

- 1x M40, 1x M50, 1x M63

Connection option:

- for 2 cables up to 5 x 25 mm²



- Dimension of enclosure: 700 x 530 mm
- Enclosure made of high-quality V2A stainless steel
- Brushed surface
- Door with box lock and single profile cylinder
- Wall mounting brackets, supplied loose
- Brush seal prevents dirt and dust from entering when door is closed
- Lockable in connected state
- Outgoing cables can be guided out through brush-sealed opening on front side
- Easy access to operating elements

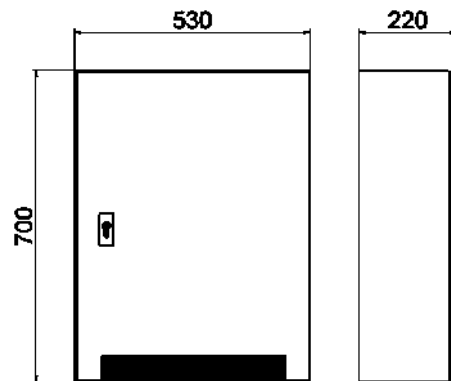

45 MB 29

Ref. no. **561449**

Components:

- 2 Domestic sockets 16A, 230V ~ (Type F - German standard)
- 1 CEE socket 16A, 400V, 5p
- 1 CEE socket 32A, 400V, 5p
- 1 CEE socket 63A, 400V, 5p

Protection:

- 2 C-type MCBs 16A, 1p
- 1 C-type MCB 16A, 3p
- 1 C-type MCB 32A, 3p
- 1 RCCB 63/0.03A, 4p

Cable entry at bottom:

- 1x M32, 1x M40, 1x M50

Connection option:

- for 2 cables up to 5 x 25 mm²



Ref. no. **562306**

Components:

- 4 Domestic sockets 16A, 230V ~ (Type F - German standard)
- 1 CEE socket 16A, 400V, 5p
- 1 CEE socket 32A, 400V, 5p
- 1 CEE socket 63A, 400V, 5p

Protection:

- 4 C-type MCBs 16A, 1p
- 1 C-type MCB 16A, 3p
- 1 C-type MCB 32A, 3p
- 1 RCCB 63/0.03A, 4p

Cable entry at bottom:

- 1x M32, 1x M40, 1x M50

Connection option:

- for 2 cables up to 5 x 25 mm²



- Dimension of enclosure: 300 x 300 mm
- Enclosure made of high-quality V2A stainless steel
- Brushed surface
- Door with box lock and single profile cylinder
- Flush-mount adapter frame
- Brush seal prevents dirt and dust from entering when door is closed
- Outgoing cables can be guided out through brush-sealed opening on front side
- Door lockable in connected state
- Easy access to operating elements

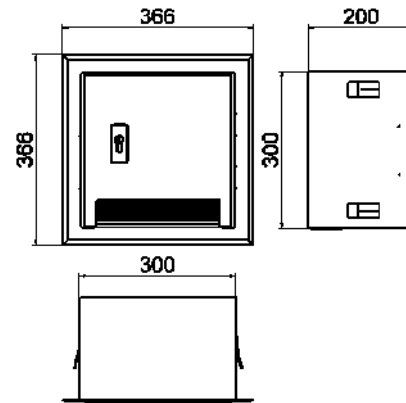

45 MB 51

Ref. no. **560509**

Components:

- 1 Domestic socket 16A, 230V ~ (Type F - German standard)
- 1 CEE socket 16A, 400V, 5p
- 1 CEE socket 32A, 400V, 5p

Cable entry at bottom:

- 1x M20, 1x M25, 1x M32

Connection option:

- for 1 cable up to 3 x 4 mm²,
- 1 cable up to 5 x 4 mm²
- and 1 cable up to 5 x 6 mm²



Ref. no. **560965**

Components:

- 2 Domestic sockets 16A, 230V ~ (Type F - German standard)
- 1 CEE socket 16A, 400V, 5p

Cable entry at bottom:

- 1x M20, 1x M25, 1x M32

Connection option:

- for 1 cable up to 5 x 6 mm²



- Dimension of enclosure: 500 x 420 mm
- Enclosure made of high-quality V2A stainless steel
- Brushed surface
- Door with box lock and single profile cylinder
- Flush-mount adapter frame
- Brush seal prevents dirt and dust from entering when door is closed
- Outgoing cables can be guided out through brush-sealed opening on front side
- Door lockable in connected state
- Easy access to operating elements

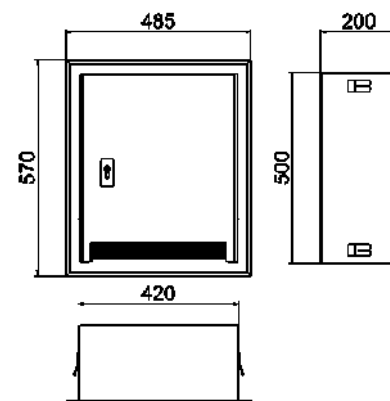

45 MB 21

Ref. no. **561844**

Components:

- 2 Domestic sockets 16A, 230V ~ (Type F - German standard)
- 1 CEE socket 16A, 400V, 5p
- 1 CEE socket 32A, 400V, 5p

Protection:

- 2 C-type MCBs 16A, 1p
- 1 C-type MCB 16A, 3p
- 1 C-type MCB 32A, 3p
- 1 RCCB 63/0.03A, 4p

Cable entry at bottom:

- 1x M25, 1x M32, 1x M40

Connection option:

- for 2 cables up to 5 x 25 mm²



Ref. no. **562379**

Components:

- 2 Domestic sockets 16A, 230V ~ (Type F - German standard)
- 2 CEE sockets 16A, 400V, 5p

Protection:

- 2 C-type MCBs 16A, 1p
- 2 C-type MCBs 16A, 3p
- 1 RCCB 40/0.03A, 4p

Cable entry at bottom:

- 1x M25, 1x M32, 1x M40

Connection option:

- for 2 cables up to 5 x 25 mm²



Combinations

Flush mounting cabinets

Technical information

- Ready wired for installation

- Dimension of enclosure: 500 x 220 mm
- Enclosure made of high-quality V2A stainless steel
- Brushed surface
- Door with box lock and single profile cylinder
- Flush-mount adapter frame
- Brush seal prevents dirt and dust from entering when door is closed
- Outgoing cables can be guided out through brush-sealed opening on front side
- Door lockable in connected state
- Easy access to operating elements

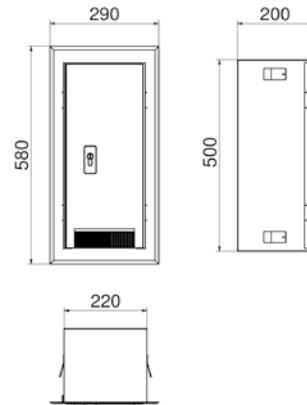

45 MB 68

Ref. no. **561872**

Components:

- 1 Domestic socket 16A, 230V ~ (Type F - German standard)
- 1 CEE socket 16A, 400V, 5p

Protection:

- 1 C-type MCB 16A, 1p
- 1 C-type MCB 16A, 3p
- 1 RCCB 40/0.03A, 4p

Cable entry at bottom:

- 1x M32, 1x M40

Connection option:

- for 2 cables up to 5 x 25 mm²



Ref. no. **562378**

Components:

- 1 Domestic socket 16A, 230V ~ (Type F - German standard)
- 1 CEE socket 32A, 400V, 5p

Protection:

- 1 C-type MCB 16A, 1p
- 1 C-type MCB 32A, 3p
- 1 RCCB 40/0.03A, 4p

Cable entry at bottom:

- 1x M32, 1x M40

Connection option:

- for 2 cables up to 5 x 25 mm²



- Dimension of enclosure: 700 x 500 mm
- Enclosure made of high-quality V2A stainless steel
- Brushed surface
- Door with box lock and single profile cylinder
- Flush-mount adapter frame
- Brush seal prevents dirt and dust from entering when door is closed
- Outgoing cables can be guided out through brush-sealed opening on front side
- Door lockable in connected state
- Easy access to operating elements

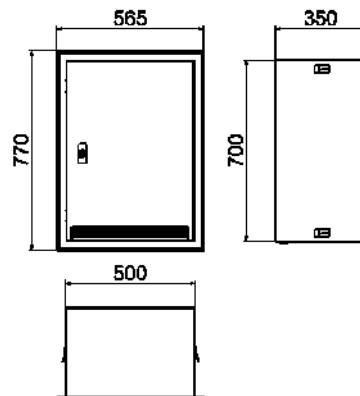

45 MB 46

Ref. no. **562380**

Components:

- 2 Domestic sockets 16A, 230V ~ (Type F - German standard)
- 2 CEE sockets 16A, 400V, 5p
- 1 CEE socket 32A, 400V, 5p
- 1 CEE socket 63A, 400V, 5p

Protection:

- 2 C-type MCBs 16A, 1p
- 2 C-type MCBs 16A, 3p
- 1 C-type MCB 32A, 3p
- 1 RCCB 63/0.03A, 4p

Cable entry at bottom:

- 1x M40, 1x M50, 1x M63

Connection option:

- for 2 cables up to 5 x 25 mm²



Ref. no. **562376**

Components:

- 4 Domestic sockets 16A, 230V ~ (Type F - German standard)
- 2 CEE sockets 16A, 400V, 5p
- 2 CEE sockets 32A, 400V, 5p

Protection:

- 4 C-type MCBs 16A, 1p
- 2 C-type MCBs 16A, 3p
- 2 C-type MCBs 32A, 3p
- 1 RCCB 63/0.03A, 4p

Cable entry at bottom:

- 1x M40, 1x M50, 1x M63

Connection option:

- for 2 cables up to 5 x 25 mm²



1

2

3

4

5

6

7

Technical information

- Wired ready for connection
- Protection degree IP44
- All distributors comply with the DIN EN 61439 / IEC 61439

- With high quality handle
- Housing made of high-grade, impact-resistant plastic
- Top and bottom can be sealed together
- Permanently attached cover screws
- Top section straight, CEE sockets angled
- All CEE sockets with screwless, maintenance-free QUICK-CONNECT technology
- Colours: bottom - black, top - electro-grey (housing top optionally available in the colours yellow, red or blue)

Ref. no. **85000**

Components:

3 domestic sockets 16A, 230V
(type F - German standard)

Cable entry:

Domestic plug 16A, 230V
with 2 m lead H07RN-F3G2,5



Ref. no. **85006**

Components:

2 domestic sockets 16A, 230V
(type F - German standard)
1 CEE socket 16A, 400V, 5p

Cable entry:

CEE plug 16A, 400V, 5p with
2 m cable H07RN-F5G2,5



Ref. no. **85007**

Components:

2 domestic sockets 16A, 230V
(type F - German standard)
1 CEE socket 16A, 400V, 5p

Fuse:

2 C-type MCBs 16A, 1p
1 C-type MCB 16A, 3p
1 RCCB 40/0.03A, 4p

Cable entry:

CEE plug 32A, 400V, 5p with
2 m cable H07RN-F5G4



Ref. no. **85002**

Components:

3 domestic sockets 16A, 230V
(type F - German standard)
2 CEE sockets 16A, 400V, 5p

Cable entry:

CEE plug 16A, 400V, 5p with
2 m cable H07RN-F5G2,5



Ref. no. **85008**

Components:

2 domestic sockets 16A, 230V
(type F - German standard)
1 CEE socket 16A, 400V, 5p
1 CEE socket 32A, 400V, 5p

Fuse:

2 C-type MCBs 16A, 1p
1 C-type MCB 16A, 3p
1 RCCB 40/0.03A, 4p

Cable entry:

CEE plug 32A, 400V, 5p with
2 m cable H07RN-F5G6



Ref. no. **85036**

Components:

6 domestic sockets 16A, 230V
(type F - German standard)

Fuse:

6 C-type MCBs 16A, 1p
1 RCCB 40/0.03A, 4p

Cable entry:

CEE plug 32A, 400V, 5p with
2 m cable H07RN-F5G4



Technical information

- Wired ready for connection
- Protection degree IP44
- All distributors comply with the DIN EN 61439 / IEC 61439

Ref. no. **85009**

Components:

3 domestic sockets 16A, 230V
(type F - German standard)
1 CEE socket 16A, 400V, 5p
1 CEE socket 32A, 400V, 5p

Fuse:

3 C-type MCBs 16A, 1p
1 C-type MCB 16A, 3p
1 RCCB 40/0.03A, 4p

Cable entry:

CEE plug 32A, 400V, 5p with
2 m cable H07RN-F5G6



Ref. no. **85016**

Components:

3 domestic sockets 16A, 230V
(type F - German standard)
1 CEE socket 16A, 400V, 5p

Fuse:

3 C-type MCBs 16A, 1p
1 C-type MCB 16A, 3p
1 RCCB 40/0.03A, 4p

Cable entry:

CEE plug 32A, 400V, 5p with
2 m cable H07RN-F5G4



Ref. no. **85034**

Components:

4 domestic sockets 16A, 230V
(type F - German standard)
1 CEE socket 16A, 400V, 5p
1 CEE socket 32A, 400V, 5p

Fuse:

4 C-type MCBs 16A, 1p
1 C-type MCB 16A, 3p
1 RCCB 40/0.03A, 4p

Cable entry:

CEE plug 32A, 400V, 5p with
2 m cable H07RN-F5G6



Ref. no. **85005**

Components:

6 domestic sockets 16A, 230V
(type F - German standard)

Fuse:

1 RCCB 40/0.03A, 4p

Cable entry:

CEE plug 16A, 400V, 5p with
2 m cable H07RN-F5G2,5



1

2

3

4

5

6

7

The mobile distributor generation

The new EVOBOX series is the ideal solution for mobile power supply in industry, on construction sites or in event technology.

Product information

- Available in 4 coordinated housing sizes
- Perfectly stackable
- Easy-to-handle, using integrated carrying grips
- No protruding components
- fuse elements under transparent operating windows
- Distributor outlets and fuse elements each separately on one side
- Ready wired for installation
- The internal wiring is designed for the highest possible safety via the specification standard
- Resistant to ageing and weather
- Lightweight and impact resistant through the use of hard-polyethylene

Product details

- Impact strength IK10, up to 20J impact energy
- Self-extinguishing and UV-stabilized
- Highly resistant thermally and mechanically
- Maintenance-free QUICK-CONNECT-technology for CEE up to 63A and domestic sockets
- Overall protection degree of the distributor is IP54
- Flexible fitting options up to 125A

The portable distributor series is available in 4 coordinated housing sizes and impresses with its high mechanical and thermal capacity.

Optional

- Adapted arrangement of panel mounting sockets for plugs with protection degree IP67
- Phase control lights are easily visible under operating windows
- External earthing screw outside the housing
- Installation of overvoltage protection
- The housing can be blue, red and orange (minimum order quantity)
- all panel mounting socket outlets are available in black

Power supply

- Cable entry with CEE plug up to max. 125A
- CEE inlet up to max. 125A

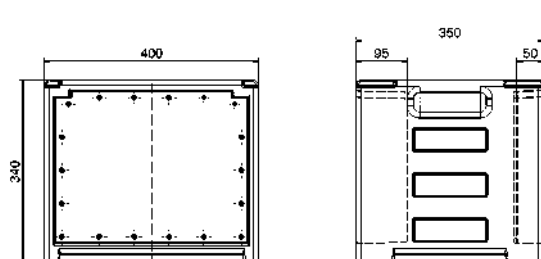

 **EVOBOX-S**

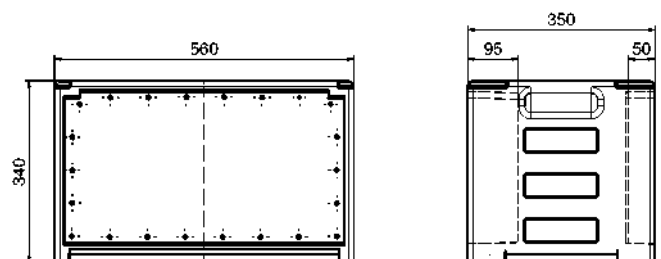

 **EVOBOX-M**

1

2

3

4

5

6

7



The 4 coordinated housing sizes

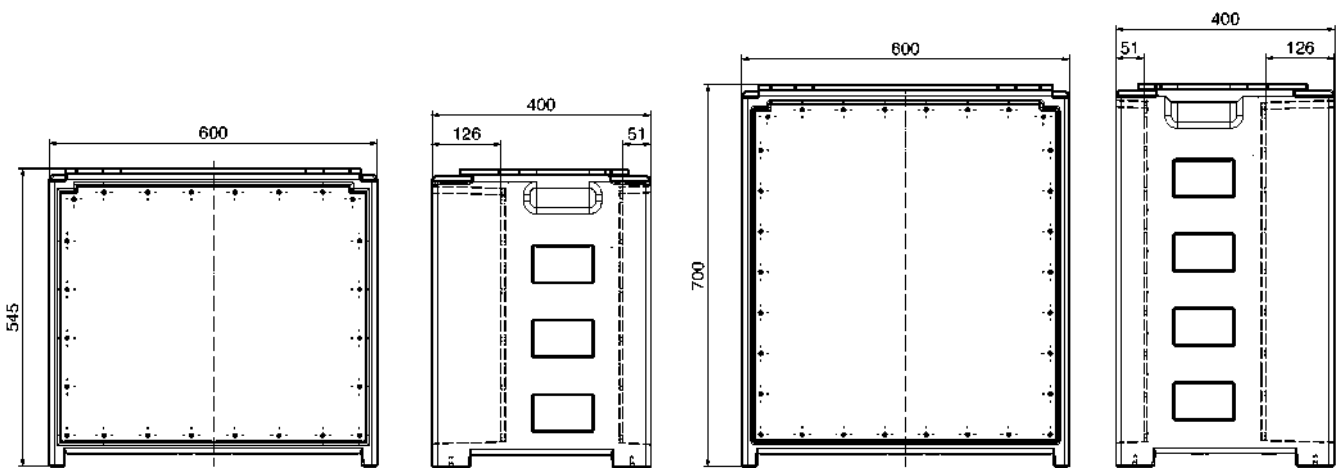

 **EVOBOX-L**

 **EVOBOX-XL**

One distributor - many areas of application

The mobile distributor generation **EVOBOX**, customized, depending on the area of application.

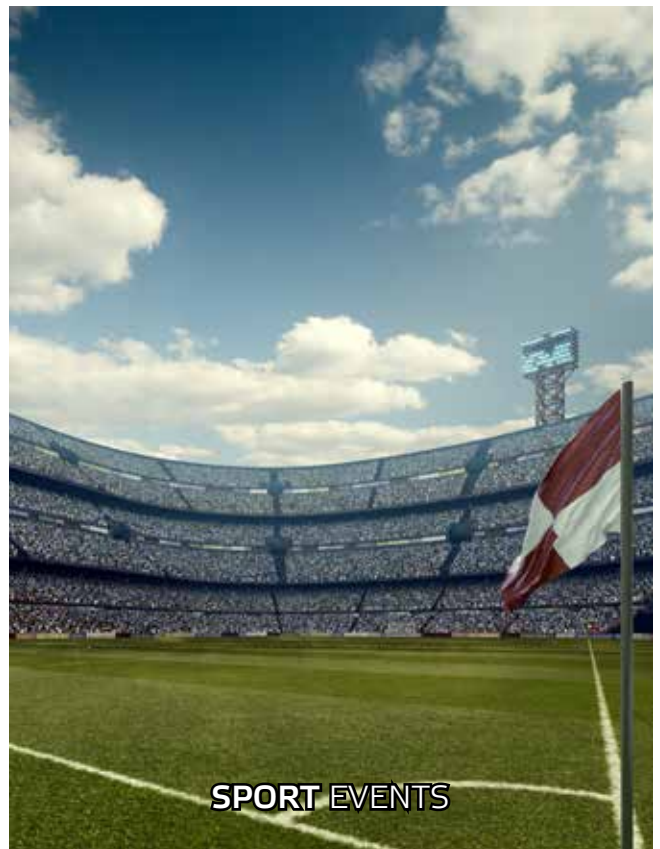

Components:

6 domestic sockets 16A, 230V, IP54
(Type F - German standard)
2 CEE sockets 16A, 400V, 5p, 6h, IP54

Fuse:

6 C-type MCBs 16A, 1p
1 C-type MCB 16A, 3p
1 RCCB 40/0,03A, 4p

Additional equipment:

1 phase control light, LED green
1 external earthing screw

Input:

1 CEE inlet 16A, 400V, 5p, 6h, IP67

Ref. no. **5202999**

 **EVOBOX-S**



1

2

Components:

9 domestic sockets 16A, 230V, IP54
(Type F - German standard)
3 CEE sockets 16A, 400V, 5p, 6h, IP54
1 CEE socket 32A, 400V, 5p, 6h, IP54

Fuse:

9 C-type MCBs 16A, 1p
3 C-type MCBs 16A, 3p
1 RCCB 40/0,03A, 4p

Additional equipment:

1 phase control light, LED green
1 external earthing screw

Input:

1 CEE inlet 32A, 400V, 5p, 6h, IP67

Ref. no. **5203000**

 **EVOBOX-M**



3

4

Components:

9 domestic sockets 16A, 230V, IP54
(Type F - German standard)
4 CEE sockets 16A, 400V, 5p, 6h, IP54
2 CEE sockets 32A, 400V, 5p, 6h, IP54
1 CEE socket 63A, 400V, 5p, 6h, IP67

Fuse:

9 C-type MCBs 16A, 1p
4 C-type MCBs 16A, 3p
2 C-type MCBs 32A, 3p
3 RCCBs 63/0,03A, 4p

Additional equipment:

1 phase control light, LED green
1 external earthing screw

Input:

1 CEE inlet 63A, 400V, 5p, 6h, IP67

Ref. no. **5203001**

 **EVOBOX-L**



5

Components:

9 domestic sockets 16A, 230V, IP54
(Type F - German standard)
4 CEE sockets 16A, 400V, 5p, 6h, IP54
4 CEE sockets 32A, 400V, 5p, 6h, IP54
2 CEE sockets 63A, 400V, 5p, 6h, IP67
1 CEE socket 125A, 400V, 5p, 6h, IP67

Fuse:

9 C-type MCBs 16A, 1p
4 C-type MCBs 16A, 3p
4 C-type MCBs 32A, 3p
4 RCCBs 63/0,03A, 4p
2 C-type MCBs 63A, 3p
2 RCCBs 63/0,5A, 4p

Additional equipment:

1 phase control light, LED green
1 external earthing screw

Input:

1 CEE inlet 125A, 400V, 5p, 6h, IP67

Ref. no. **5203002**

 **EVOBOX-XL**



6

7

Combinations

Solid-Rubber distributor, portable

Technical information

- Wired ready for connection
- Protection degree IP44
- All distributors comply with the DIN EN 61439 / IEC 61439

- Enclosure made of high-quality, impact-resistant solid rubber
- Small, compact design
- Top and bottom in signal yellow
- Handle made of stainless steel

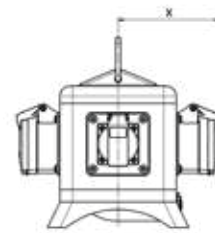
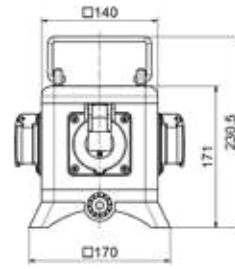

13 MB 123

Depth X (in mm)

Component	IP44	IP67
Operating window	90	
Domestic socket	98,5	114
CEE 16A 3p	121	127
CEE 16A 4p	123	128

Component	IP44	IP67
CEE 16A 5p	127	130
CEE 32A 3p / 4p	130	135
CEE 32A 5p	139	139

Ref. no. **576086**

Components:

- 1 CEE socket 16A, 400V, 5p
- 1 electricity meter 10/65A

Cable entry/inlet:

CEE plug 16A, 400V, 5p with lead 2 m H07RN-F5G1,5



Ref. no. **57148**

Components:

- 2 Domestic sockets 16A, 230V ~ (type F - German standard)
- 2 CEE sockets 16A, 400V, 5p

Cable entry/inlet:

CEE plug 16A, 400V, 5p with lead 2 m H07RN-F5G2,5



Ref. no. **57623**

Components:

- 4 Domestic sockets 16A, 230V ~ (type F - German standard)

Cable entry/inlet:

Domestic plug 16A, 230V, 3p
4 m cable H07RN-F3G2,5



Ref. no. **57996**

Components:

- 2 Domestic sockets 16A, 230V ~ (type F - German standard)
- 1 CEE socket 16A, 400V, 5p
- 1 rotary field measuring device

Fuse:

- 1 RCCB 40/0.03A, 4p

Cable entry/inlet:

CEE phase inverter 16A, 400V, 5p with lead 2 m H07RN-F5G2,5



Ref. no. **57255**

Components:

- 2 Domestic sockets 16A, 230V ~ (type F - German standard)
- 1 CEE socket 16A, 400V, 5p

Fuse:

- 1 RCCB 40/0.03A, 4p

Cable entry/inlet:

CEE plug 16A, 400V, 5p with lead 2 m H07RN-F5G2,5



Ref. no. **57143**

Components:

- 3 Domestic sockets 16A, 230V ~ (type F - German standard)
- 1 CEE socket 16A, 400V, 5p

Cable entry/inlet:

CEE plug 16A, 400V, 5p with lead 2 m H07RN-F5G2,5



Technical information

- Wired ready for connection
- Protection degree IP44
- All distributors comply with the DIN EN 61439 / IEC 61439

- Enclosure made of high-quality, impact-resistant solid rubber
- Ideally suited to tough, harsh and difficult conditions
- Convenient and compact design
- With moulded carrying handle

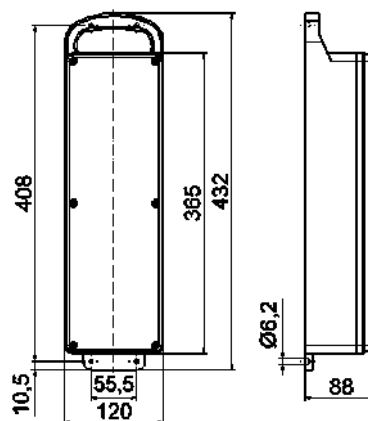

13 MB 7

Ref. no. **530179**

Components:

- 1 Domestic socket 16A, 230V ~ (type F - German standard)
- 1 CEE socket 16A, 400V, 5p
- 1 CEE socket 32A, 400V, 5p

Fuse:

- 1 C-type MCB 16A, 1p
- 1 C-type MCB 16A, 3p

Cable entry/inlet:

- CEE plug 32A, 400V, 5p with lead 1.8 m H07RN-F5G4



Ref. no. **5310**

Components:

- 3 CEE sockets 16A, 400V, 5p

Cable entry/inlet:

- CEE plug 16A, 400V, 5p with lead 1.8 m H07RN-F5G2,5



Ref. no. **53141**

Components:

- 4 Domestic sockets 16A, 230V ~ (type F - German standard)

Fuse:

- 1 RCCB 25/0.03A, 2p

Cable entry/inlet:

- Domestic plug 16A, 230V, 3p with 2 m lead H07RN-F3G2,5



Ref. no. **53525**

Components:

- 3 CEE sockets 32A, 400V, 5p

Cable entry/inlet:

- CEE plug 32A, 400V, 5p with lead 2 m H07RN-F5G4



Ref. no. **53420**

Components:

- 2 CEE sockets 16A, 400V, 5p

Fuse:

- 2 C-type MCBs 16A, 3p

Cable entry/inlet:

- CEE plug 32A, 400V, 5p with lead 2 m H07RN-F5G6



Ref. no. **53290**

Components:

- 4 Domestic sockets 16A, 230V ~ (type F - German standard)
- 1 CEE socket 16A, 400V, 5p

Cable entry/inlet:

- CEE plug 16A, 400V, 5p with lead 2 m H07RN-F5G2,5



1

2

3

4

5

6

7

Combinations

Solid-Rubber distributor, portable

Technical information

- Wired ready for connection
- Protection degree IP44
- All distributors comply with the DIN EN 61439 / IEC 61439

Ref. no. **530003**

Components:

2 Domestic sockets 16A, 230V ~
(type F - German standard)
1 CEE socket 16A, 400V, 5p

Fuse:

2 C-type MCBs 16A, 1p
1 RCCB 40/0.03A, 4p

Cable entry/inlet:

CEE plug 16A, 400V, 5p with
lead 2 m H07RN-F5G2,5



Ref. no. **530**

Components:

2 Domestic sockets 16A, 230V ~
(type F - German standard)
1 CEE socket 16A, 400V, 5p

Fuse:

1 RCCB 40/0.03A, 4p

Cable entry/inlet:

CEE plug 16A, 400V, 5p with
lead 1.8 m H07RN-F5G2,5



Ref. no. **5311**

Components:

2 Domestic sockets 16A, 230V ~
(type F - German standard)
1 CEE socket 16A, 400V, 5p

Cable entry/inlet:

CEE plug 16A, 400V, 5p with
lead 1.8 m H07RN-F5G2,5



Ref. no. **5350**

Components:

3 Domestic sockets 16A, 230V ~
(type F - German standard)

Cable entry/inlet:

Domestic plug 16A, 230V, 3p
with 2 m cable H07RN-F3G2,5



Ref. no. **53247**

Components:

6 Domestic sockets 16A, 230V ~
(type F - German standard)

Cable entry/inlet:

CEE plug 16A, 400V, 5p with
lead 2 m H07RN-F5G2,5



Ref. no. **53213**

Components:

4 Domestic sockets 16A, 230V ~
(type F - German standard)

Fuse:

1 RCCB 40/0.03A, 4p

Cable entry/inlet:

CEE plug 16A, 400V, 5p with
lead 2 m H07RN-F5G2,5



Ref. no. **5321**

Components:

3 Domestic sockets 16A, 230V ~
(type F - German standard)

Fuse:

1 RCCB 40/0.03A, 4p

Cable entry/inlet:

CEE plug 16A, 400V, 5p with
lead 2 m H07RN-F5G2,5



Ref. no. **530321**

Components:

3 CEE sockets 16A, 400V, 5p

Fuse:

1 RCCB 40/0.03A, 4p

Cable entry/inlet:

CEE plug 16A, 400V, 5p with
lead 2 m H07RN-F5G2,5



Technical information

- Wired ready for connection
- Protection degree IP44
- All distributors comply with the DIN EN 61439 / IEC 61439

- Enclosure made of high-quality, impact-resistant solid rubber
- Ideally suited to tough, harsh and difficult conditions
- Convenient and compact design
- With moulded carrying handle

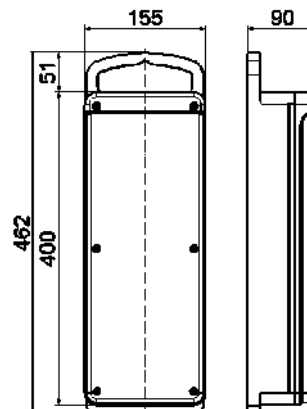

13 MB 54

Ref. no. **53909**

Components:

6 Domestic sockets 16A, 230V ~
(type F - German standard)

Fuse:

3 C-type MCBs 16A, 1p
1 RCCB 40/0.03A, 4p

Cable entry/inlet:

CEE plug 32A, 400V, 5p with
lead 2 m H07RN-F5G4



Ref. no. **53681**

Components:

6 Domestic sockets 16A, 230V ~
(type F - German standard)
1 CEE socket 16A, 400V, 5p

Fuse:

1 RCCB 40/0.03A, 4p

Cable entry/inlet:

CEE plug 16A, 400V, 5p with
lead 2 m H07RN-F5G2,5



Ref. no. **53679**

Components:

12 Domestic sockets 16A, 230V ~
(type F - German standard)

Cable entry/inlet:

CEE plug 16A, 400V, 5p with
lead 2 m H07RN-F5G2,5



Ref. no. **530090**

Components:

6 Domestic sockets 16A, 230V ~
(type F - German standard)
1 CEE socket 32A, 400V, 5p

Fuse:

3 C-type MCBs 16A, 1p
1 RCCB 40/0.03A, 4p

Cable entry/inlet:

CEE plug 32A, 400V, 5p with
lead 2 m H07RN-F5G4



Ref. no. **530425**

Components:

6 Domestic sockets 16A, 230V ~
(type F - German standard)
1 CEE socket 16A, 400V, 5p

Fuse:

3 C-type MCBs 16A, 1p
1 RCCB 40/0.03A, 4p

Cable entry/inlet:

CEE plug 16A, 400V, 5p with
lead 2 m H07RN-F5G2,5



Ref. no. **530426**

Components:

2 Domestic sockets 16A, 230V ~
(type F - German standard)
1 CEE socket 16A, 400V, 5p
1 CEE socket 32A, 400V, 5p

Fuse:

2 C-type MCBs 16A, 1p
1 C-type MCB 16A, 3p

Cable entry/inlet:

CEE plug 32A, 400V, 5p with
lead 2 m H07RN-F5G4



1

2

3

4

5

6

7

Combinations

Solid-Rubber distributor, portable

Technical information

- Wired ready for connection
- Protection degree IP44
- All distributors comply with the DIN EN 61439 / IEC 61439

- Enclosure made of high-quality, impact-resistant solid rubber
- Ideally suited to tough, harsh and difficult conditions
- Robust solid-rubber handle with hook for cable
- Lockable stainless-steel quick-release fasteners
- Hinged lid, user-friendly access to protective equipment
- Stackable, foot attachment on enclosure cover
- High rubber feet to avoid dirt at floor level

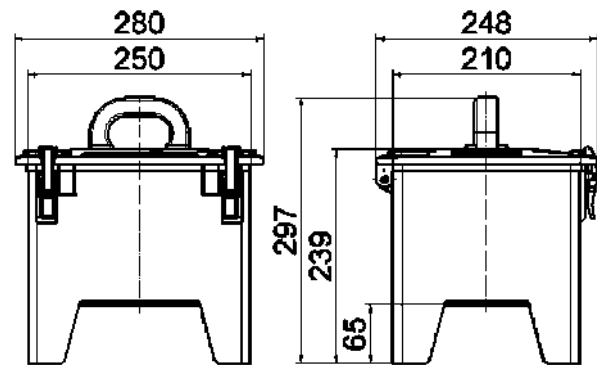

13 MB 43

Ref. no. **5226**

Components:

- 4 Domestic sockets 16A, 230V ~ (type F - German standard)
- 2 CEE sockets 16A, 400V, 5p
- 1 CEE socket 32A, 400V, 5p

Fuse:

- 2 Neozed D01, 1p
- 2 Neozed D01, 3p

Cable entry/inlet:

- CEE inlet 32A, 400V, 5p



Ref. no. **522590**

Components:

- 6 Domestic sockets 16A, 230V ~ (type F - German standard)
- 2 CEE sockets 16A, 400V, 5p
- 1 CEE socket 32A, 400V, 5p
- 1 rotary field measuring device

Fuse:

- 3 C-type MCBs 16A, 1p
- 1 C-type MCB 16A, 3p
- 1 RCCB 40/0.03A, 4p

Cable entry/inlet:

- CEE phase inverter 32A, 400V, 5p



Ref. no. **5201558**

Components:

- 3 Domestic sockets 16A, 230V ~ (type F - German standard)
- 2 CEE sockets 16A, 400V, 5p
- 1 CEE socket 32A, 400V, 5p

Fuse:

- 3 C-type MCBs 16A, 1p
- 1 C-type MCB 16A, 3p
- 1 RCCB 40/0.03A, 4p

Cable entry/inlet:

- CEE inlet 32A, 400V, 5p



Ref. no. **5201047**

Components:

- 4 Domestic sockets 16A, 230V ~ (type F - German standard)
- 2 CEE sockets 16A, 400V, 5p
- 1 CEE socket 32A, 400V, 5p

Fuse:

- 4 C-type MCBs 16A, 1p
- 2 C-type MCBs 16A, 3p
- 1 RCCB 40/0.03A, 4p

Cable entry/inlet:

- CEE inlet 32A, 400V, 5p



Ref. no. **522144**

Components:

- 2 Domestic sockets 16A, 230V ~ (type F - German standard)
- 2 CEE sockets 16A, 400V, 5p
- 2 CEE sockets 32A, 400V, 5p

Fuse:

- 1 Neozed D01, 1p
- 1 Neozed D01, 3p

Cable entry/inlet:

- CEE inlet 32A, 400V, 5p



Ref. no. **5201015**

Components:

- 4 Domestic sockets 16A, 230V ~ (type F - German standard)
- 1 CEE socket 16A, 400V, 5p
- 1 CEE socket 32A, 400V, 5p

Fuse:

- 2 C-type MCBs 16A, 1p
- 1 C-type MCB 16A, 3p
- 1 RCCB 40/0.03A, 4p

Cable entry/inlet:

- CEE plug 32A, 400V, 5p with lead 2 m H07RN-F5G4



Technical information

- Wired ready for connection
- Protection degree IP44
- All distributors comply with the DIN EN 61439 / IEC 61439

Ref. no. **5201926**

Components:

- 4 Domestic sockets 16A, 230V ~ (type F - German standard)
- 1 CEE socket 16A, 400V, 5p
- 2 CEE sockets 32A, 400V, 5p

Fuse:

- 2 C-type MCBs 16A, 1p
- 1 C-type MCB 16A, 3p
- 1 RCCB 40/0.03A, 4p

Cable entry/inlet:

- CEE plug 32A, 400V, 5p with 3 m cable H07RN-F5G6



Ref. no. **5202236**

Components:

- 3 Domestic sockets 16A, 230V ~ (type F - German standard)
- 2 CEE sockets 16A, 400V, 5p
- 2 CEE sockets 32A, 400V, 5p

Fuse:

- 3 C-type MCBs 16A, 1p
- 2 C-type MCBs 16A, 3p
- 1 RCCB 40/0.03A, 4p

Cable entry/inlet:

- CEE inlet 32A, 400V, 5p



Ref. no. **5200568**

Components:

- 3 Domestic sockets 16A, 230V ~ (type F - German standard)
- 3 CEE sockets 32A, 400V, 5p

Fuse:

- 3 C-type MCBs 16A, 1p
- 1 RCCB 40/0.03A, 4p

Cable entry/inlet:

- CEE inlet 32A, 400V, 5p



Ref. no. **524449**

Components:

- 4 Domestic sockets 16A, 230V ~ (type F - German standard)
- 2 CEE sockets 32A, 400V, 5p

Fuse:

- 4 C-type MCBs 16A, 1p

Cable entry/inlet:

- CEE inlet 32A, 400V, 5p



Ref. no. **5225**

Components:

- 4 Domestic sockets 16A, 230V ~ (type F - German standard)
- 2 CEE sockets 16A, 400V, 5p

Cable entry/inlet:

- CEE inlet 16A, 400V, 5p



Ref. no. **5201004**

Components:

- 3 Domestic sockets 16A, 230V ~ (type F - German standard)
- 1 CEE socket 16A, 400V, 5p
- 2 CEE sockets 32A, 400V, 5p

Fuse:

- 3 C-type MCBs 16A, 1p
- 1 C-type MCB 16A, 3p
- 1 RCCB 40/0.03A, 4p

Cable entry/inlet:

- CEE inlet 32A, 400V, 5p



Ref. no. **5200917**

Components:

- 4 Domestic sockets 16A, 230V ~ (type F - German standard)
- 1 CEE socket 16A, 400V, 5p
- 1 CEE socket 32A, 400V, 5p

Fuse:

- 2 C-type MCBs 16A, 1p
- 1 C-type MCB 16A, 3p
- 1 RCCB 40/0.03A, 4p

Cable entry/inlet:

- CEE inlet 32A, 400V, 5p



Ref. no. **5202237**

Components:

- 3 Domestic sockets 16A, 230V ~ (type F - German standard)
- 2 CEE sockets 16A, 400V, 5p
- 1 CEE socket 32A, 400V, 5p

Fuse:

- 3 C-type MCBs 16A, 1p
- 1 C-type MCB 16A, 3p
- 1 RCCB 40/0.03A, 4p

Cable entry/inlet:

- CEE plug 32A, 400V, 5p with lead 3 m H07RN-F5G4



1

2

3

4

5

6

7

Combinations

Solid-Rubber distributor, portable

Technical information

- Wired ready for connection
- Protection degree IP44
- All distributors comply with the DIN EN 61439 / IEC 61439

Ref. no. **526**

Components:

5 Domestic sockets 16A, 230V ~
(type F - German standard)
2 CEE sockets 16A, 400V, 5p

Cable entry/inlet:

CEE inlet 16A, 400V, 5p



Ref. no. **5202238**

Components:

4 Domestic sockets 16A, 230V ~
(type F - German standard)
1 CEE socket 16A, 400V, 5p
2 CEE sockets 32A, 400V, 5p

Fuse:

4 C-type MCBs 16A, 1p
1 C-type MCB 16A, 3p
1 RCCB 40/0.03A, 4p

Cable entry/inlet:

CEE inlet 32A, 400V, 5p



Ref. no. **522143**

Components:

3 Domestic sockets 16A, 230V ~
(type F - German standard)
2 CEE sockets 16A, 400V, 5p
1 CEE socket 32A, 400V, 5p

Fuse:

3 Neozed D01, 1p
1 Neozed D01, 3p
1 RCCB 40/0.03A, 4p

Cable entry/inlet:

CEE inlet 32A, 400V, 5p



Ref. no. **52638**

Components:

4 Domestic sockets 16A, 230V ~
(type F - German standard)
2 CEE sockets 16A, 400V, 5p

Fuse:

1 RCCB 40/0.03A, 4p

Cable entry/inlet:

CEE plug 16A, 400V, 5p with
lead 2 m H07RN-F5G2,5



Ref. no. **5201555**

Components:

3 Domestic sockets 16A, 230V ~
(type F - German standard)
1 CEE socket 16A, 400V, 5p
1 CEE socket 32A, 400V, 5p

Fuse:

3 C-type MCBs 16A, 1p
1 C-type MCB 16A, 3p
1 RCCB 40/0.03A, 4p

Cable entry/inlet:

CEE inlet 32A, 400V, 5p



Ref. no. **52480**

Components:

4 Domestic sockets 16A, 230V ~
(type F - German standard)
2 CEE sockets 16A, 400V, 5p

Fuse:

1 RCCB 40/0.03A, 4p

Cable entry/inlet:

CEE inlet 16A, 400V, 5p



Ref. no. **522589**

Components:

6 Domestic sockets 16A, 230V ~
(type F - German standard)
2 CEE sockets 16A, 400V, 5p
1 rotary field measuring device

Fuse:

3 C-type MCBs 16A, 1p
1 RCCB 40/0.03A, 4p

Cable entry/inlet:

CEE phase inverter 16A, 400V, 5p



Ref. no. **523291**

Components:

6 Domestic sockets 16A, 230V ~
(type F - German standard)

Fuse:

6 C-type MCBs 16A, 1p
1 RCCB 40/0.03A, 4p

Cable entry/inlet:

CEE plug 32A, 400V, 5p with
lead 3 m H07RN-F5G4



Technical information

- Wired ready for connection
- Protection degree IP44
- All distributors comply with the DIN EN 61439 / IEC 61439

- Enclosure made of high-quality, impact-resistant solid rubber
- Ideally suited to tough, harsh and difficult conditions
- Robust solid-rubber handle with hook for cable
- Lockable stainless-steel quick-release fasteners
- Hinged lid, user-friendly access to protective equipment
- Stackable, foot attachment on enclosure cover
- High rubber feet to avoid dirt at floor level

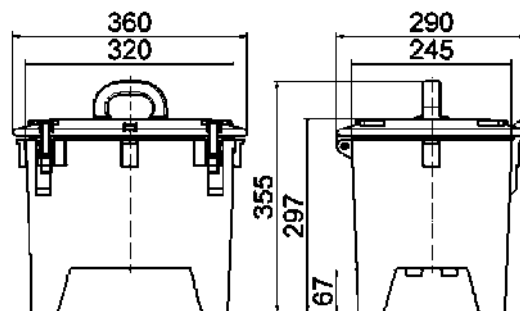

13 MB 36

Ref. no. **5202239**

Components:

- 4 Domestic sockets 16A, 230V ~ (type F - German standard)
- 2 CEE sockets 16A, 400V, 5p
- 2 CEE sockets 32A, 400V, 5p

Fuse:

- 4 C-type MCBs 16A, 1p
- 2 C-type MCBs 16A, 3p
- 2 C-type MCBs 32A, 3p
- 1 RCCB 63/0.03A, 4p

Cable entry/inlet:

- CEE plug 63A, 400V, 5p with lead 2 m H07RN-F5G10



Ref. no. **5202240**

Components:

- 4 Domestic sockets 16A, 230V ~ (type F - German standard)
- 1 CEE socket 16A, 400V, 5p
- 1 CEE socket 32A, 400V, 5p
- 1 CEE socket 63A, 400V, 5p

Fuse:

- 2 C-type MCBs 16A, 1p
- 1 C-type MCB 16A, 3p
- 1 C-type MCB 32A, 3p
- 1 RCCB 63/0.03A, 4p

Cable entry/inlet:

- CEE plug 63A, 400V, 5p with lead 3 m H07RN-F5G10



Ref. no. **524443**

Components:

- 4 Domestic sockets 16A, 230V ~ (type F - German standard)
- 3 CEE sockets 16A, 400V, 5p
- 1 CEE socket 32A, 400V, 5p

Fuse:

- 2 Neozed D01, 1p
- 3 Neozed D01, 3p

Cable entry/inlet:

- CEE plug 32A, 400V, 5p with lead 3 m H07RN-F5G4



Ref. no. **522167**

Components:

- 4 Domestic sockets 16A, 230V ~ (type F - German standard)
- 3 CEE sockets 16A, 400V, 5p
- 1 CEE socket 32A, 400V, 5p

Fuse:

- 2 Neozed D01, 1p
- 3 Neozed D01, 3p

Cable entry/inlet:

- CEE inlet 32A, 400V, 5p



Ref. no. **521828**

Components:

- 4 Domestic sockets 16A, 230V ~ (type F - German standard)
- 4 CEE sockets 32A, 400V, 5p

Fuse:

- 4 Neozed D01, 1p
- 1 RCCB 40/0.03A, 4p

Cable entry/inlet:

- CEE inlet 32A, 400V, 5p



Ref. no. **5202241**

Components:

- 4 Domestic sockets 16A, 230V ~ (type F - German standard)
- 1 CEE socket 16A, 400V, 5p
- 1 CEE socket 32A, 400V, 5p
- 1 CEE socket 63A, 400V, 5p

Fuse:

- 2 C-type MCBs 16A, 1p
- 1 C-type MCB 16A, 3p
- 1 C-type MCB 32A, 3p
- 1 RCCB 63/0.03A, 4p

Cable entry/inlet:

- CEE inlet 63A, 400V, 5p



Combinations

Solid-Rubber distributor, portable

Technical information

- Wired ready for connection
- Protection degree IP44
- All distributors comply with the DIN EN 61439 / IEC 61439

Ref. no. **524446**

Components:

- 4 Domestic sockets 16A, 230V ~ (type F - German standard)
- 1 CEE socket 16A, 400V, 5p
- 1 CEE socket 32A, 400V, 5p
- 1 CEE socket 63A, 400V, 5p

Fuse:

- 2 Neozed D01, 1p
- 1 Neozed D01, 3p
- 1 Neozed D02, 3p
- 1 RCCB 63/0.03A, 4p

Cable entry/inlet:

- CEE plug 63A, 400V, 5p with lead 3 m H07RN-F5G10



Ref. no. **5202242**

Components:

- 6 Domestic sockets 16A, 230V ~ (type F - German standard)
- 1 CEE socket 16A, 400V, 5p
- 1 CEE socket 32A, 400V, 5p
- 1 CEE socket 63A, 400V, 5p

Fuse:

- 6 C-type MCBs 16A, 1p
- 1 C-type MCB 16A, 3p
- 1 C-type MCB 32A, 3p
- 1 RCCB 63/0.03A, 4p

Cable entry/inlet:

- CEE plug 63A, 400V, 5p with lead 2 m H07RN-F5G16



Ref. no. **5202469**

Components:

- 6 Domestic sockets 16A, 230V ~ (type F - German standard)
- 1 CEE socket 16A, 400V, 5p
- 1 CEE socket 32A, 400V, 5p
- 1 CEE socket 63A, 400V, 5p

Fuse:

- 6 C-type MCBs 16A, 1p
- 1 C-type MCB 16A, 3p
- 1 C-type MCB 32A, 3p
- 1 RCCB 63/0.03A, 4p

Cable entry/inlet:

- CEE inlet 63A, 400V, 5p



Ref. no. **5202243**

Components:

- 8 Domestic sockets 16A, 230V ~ (type F - German standard)
- 1 CEE socket 16A, 400V, 5p
- 1 CEE socket 32A, 400V, 5p

Fuse:

- 4 C-type MCBs 16A, 1p
- 1 C-type MCB 16A, 3p
- 1 RCCB 40/0.03A, 4p

Cable entry/inlet:

- CEE plug 32A, 400V, 5p with lead 3 m H07RN-F5G4



Ref. no. **5202244**

Components:

- 8 Domestic sockets 16A, 230V ~ (type F - German standard)
- 1 CEE socket 16A, 400V, 5p
- 1 CEE socket 32A, 400V, 5p

Fuse:

- 4 C-type MCBs 16A, 1p
- 1 C-type MCB 16A, 3p
- 1 RCCB 40/0.03A, 4p

Cable entry/inlet:

- CEE inlet 32A, 400V, 5p



Ref. no. **5201003**

Components:

- 3 Domestic sockets 16A, 230V ~ (type F - German standard)
- 1 CEE socket 16A, 400V, 5p
- 2 CEE sockets 32A, 400V, 5p
- 1 CEE socket 63A, 400V, 5p

Fuse:

- 3 C-type MCBs 16A, 1p
- 1 C-type MCB 16A, 3p
- 2 C-type MCBs 32A, 3p
- 1 RCCB 63/0.03A, 4p

Cable entry/inlet:

- CEE inlet 63A, 400V, 5p



Ref. no. **5202245**

Components:

- 4 Domestic sockets 16A, 230V ~ (type F - German standard)
- 2 CEE sockets 16A, 400V, 5p
- 2 CEE sockets 32A, 400V, 5p

Fuse:

- 2 C-type MCBs 16A, 1p
- 2 C-type MCBs 16A, 3p
- 2 C-type MCBs 32A, 3p
- 1 RCCB 63/0.03A, 4p

Cable entry/inlet:

- CEE plug 63A, 400V, 5p with lead 3 m H07RN-F5G10



Ref. no. **5202470**

Components:

- 4 Domestic sockets 16A, 230V ~ (type F - German standard)
- 2 CEE sockets 16A, 400V, 5p
- 2 CEE sockets 32A, 400V, 5p

Fuse:

- 2 C-type MCBs 16A, 1p
- 2 C-type MCBs 16A, 3p
- 2 C-type MCBs 32A, 3p
- 1 RCCB 63/0.03A, 4p

Cable entry/inlet:

- CEE inlet 63A, 400V, 5p



Technical information

- Wired ready for connection
- Protection degree IP44
- All distributors comply with the DIN EN 61439 / IEC 61439

- Enclosure made of high-grade, impact-resistant plastic
- Hinged window can optional be locked and lead-sealed
- 9 modules can be installed on each enclosure side
- Hinged lid
- Handle bracket in signal yellow

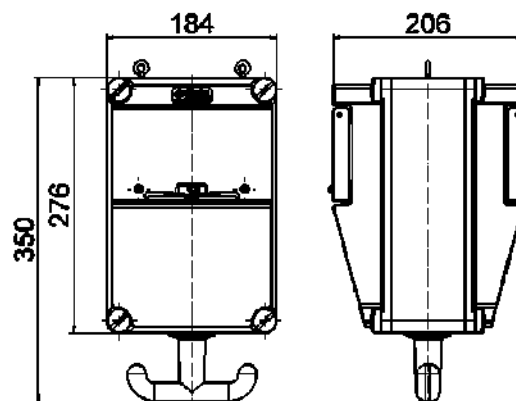

30 MB 186

Ref. no. **572567**

Components:

2 Domestic sockets 16A, 230V ~
(type F - German standard)
2 CEE sockets 16A, 400V, 5p

Protection:

2 C-type MCBs 16A, 1p
2 C-type MCBs 16A, 3p
1 RCCB 40/0.03A, 4p

Cable entry:

1x M40

Connection option:

for 1 cable up to 5 x 10 mm²



Ref. no. **574339**

Components:

2 Domestic sockets 16A, 230V ~
(type F - German standard)
1 CEE socket 16A, 400V, 5p
1 CEE socket 32A, 400V, 5p

Protection:

2 C-type MCBs 16A, 1p
1 C-type MCB 16A, 3p
1 C-type MCB 32A, 3p
1 RCCB 40/0.03A, 4p

Cable entry:

1x M40

Connection option:

for 1 cable up to 5 x 25 mm²



Ref. no. **573671**

Components:

6 Domestic sockets 16A, 230V ~
(type F - German standard)

Protection:

6 C-type MCBs 16A, 1p
1 RCCB 40/0.03A, 4p

Cable entry:

1 x M32

Connection option:

for 1 cable up to 5 x 16 mm²



Ref. no. **572551**

Components:

4 Domestic sockets 16A, 230V ~
(type F - German standard)

Protection:

4 C-type MCBs 16A, 1p
1 RCCB 40/0.03A, 4p

Cable entry:

1x M32

Connection option:

for 1 cable up to 5 x 25 mm²



Ref. no. **572185**

Components:

3 Domestic sockets 16A, 230V ~
(type F - German standard)
1 CEE socket 16A, 400V, 5p

Protection:

3 C-type MCBs 16A, 1p
1 C-type MCB 16A, 3p
1 RCCB 40/0.03A, 4p

Cable entry:

1x M32

Connection option:

for 1 cable up to 5 x 10 mm²



Ref. no. **574420**

Components:

2 Domestic sockets 16A, 230V ~
(type F - German standard)
2 CEE sockets 16A, 400V, 5p
1 compressed air connection:
Input: 1/2" pipe with external thread
Output: 1/2" quick-release connector

Protection:

2 C-type MCBs 16A, 1p
2 C-type MCBs 16A, 3p

Cable entry:

1x M32

Connection option:

for 1 cable up to 5 x 25 mm²



Combinations

Cross distributors

Technical information

- Wired ready for connection
- Protection degree IP44
- All distributors comply with the DIN EN 61439 / IEC 61439

- Enclosure made of high-grade, impact-resistant plastic
- Small, compact design
- Variable configuration
- Hanging bracket made of V2A stainless steel

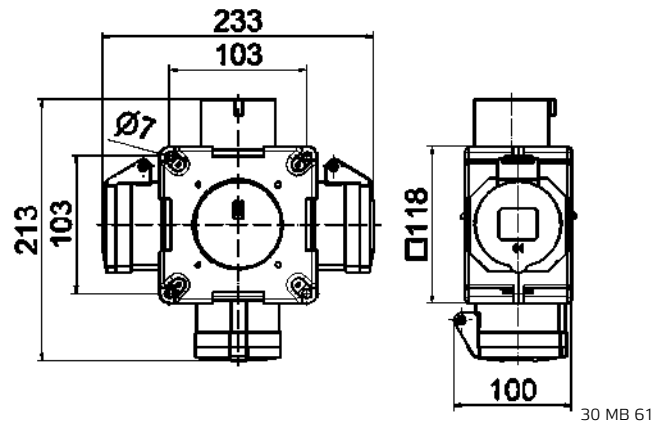

Ref. no. **54655**

Components:

- 2 Domestic sockets 16A, 230V ~ (type F - German standard)
- 1 CEE socket 16A, 230V, 3p

Cable entry/Input:

- 1 CEE inlet 16A, 230V, 3p



Ref. no. **54657**

Components:

- 2 Domestic sockets 16A, 230V ~ (type F - German standard)
- 1 CEE socket 16A, 400V, 5p

Cable entry/Input:

- 1 CEE plug 16A, 400V, 5p with 1.5 m cable H07RN-F5G2,5



Ref. no. **54880**

Components:

- 3 Domestic sockets 16A, 230V ~ (type F - German standard)
- 1 CEE socket 16A, 400V, 5p

Cable entry/Input:

- 1x M25

Connection option:

- for 1 cable up to 5x 2.5 mm²



Ref. no. **54568**

Components:

- 3 CEE sockets 16A, 230V, 3p

Cable entry/Input:

- 1 CEE plug 16A, 230V, 3p with 1.5 m cable H07RN-F3G2,5



Ref. no. **54566**

Components:

- 3 CEE sockets 16A, 230V, 3p

Cable entry/Input:

- 1 CEE inlet 16A, 230V, 3p



Ref. no. **54569**

Components:

- 3 CEE sockets 16A, 400V, 5p

Cable entry/Input:

- 1 CEE plug 16A, 400V, 5p with 1.5 m cable H07RN-F5G2,5



Technical information

- Wired ready for connection
- Protection degree IP44
- All distributors comply with the DIN EN 61439 / IEC 61439

Ref. no. **546**

Components:

3 CEE sockets 16A, 400V, 5p

Cable entry/Input:

1 CEE inlet 16A, 400V, 5p



Ref. no. **54567**

Components:

3 CEE sockets 32A, 400V, 5p

Cable entry/Input:

1 CEE inlet 32A, 400V, 5p



Ref. no. **54740**

Components:

2 Domestic sockets 16A, 230V ~
(type F - German standard)
1 CEE socket 16A, 400V, 5p

Cable entry/Input:

1x M25

Connection option:

for 1 cable up to 5x 2.5 mm²



Ref. no. **54929**

Components:

4 Domestic sockets 16A, 230V ~
(type F - German standard)

Cable entry/Input:

1x M25

Connection option:

for 1 cable up to 5x 2.5 mm²



Ref. no. **540055**

Components:

1 Domestic socket 16A, 230V ~
(type F - German standard)
2 CEE sockets 16A, 400V, 5p

Cable entry/Input:

1x M25

Connection option:

for 1 cable up to 5x 2.5 mm²



Ref. no. **54741**

Components:

3 Domestic sockets 16A, 230V, 3p

Cable entry/Input:

1x M25

Connection option:

for 1 cable up to 5x 2.5 mm²



Ref. no. **54580**

Components:

2 Domestic sockets 16A, 230V ~
(type F - German standard)
1 CEE socket 16A, 400V, 5p

Cable entry/Input:

1 CEE inlet 16A, 400V, 5p



Ref. no. **54801**

Components:

3 Domestic sockets 16A, 230V ~
(type F - German standard)

Cable entry/Input:

1x M25

Connection option:

for 1 cable up to 5x 2.5 mm²



1

2

3

4

5

6

7

Combinations

Solid-Rubber distributor, hanging

Technical information

- Wired ready for connection
- Protection degree IP44
- All distributors comply with the DIN EN 61439 / IEC 61439

- Enclosure made of high-quality, impact-resistant solid rubber
- Small, compact design
- Variable configuration
- Fuse protection and data systems safely protected behind an operating window
- Top and bottom in signal yellow
- Hanging bracket made of V2A stainless steel
- Easy connection and disconnection of loads by means of knob or handle bracket
- Unproblematic connection of supply cable by means of specially developed clamping ring

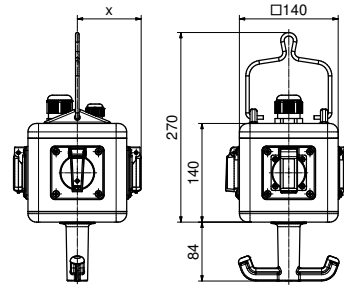

13 MB 124

Depth X (in mm)

Component	IP44	IP67	Component	IP44	IP67
Operating window	90		CEE 16A 5p	127	130
Domestic socket	98,5	114	CEE 32A 3p / 4p	130	135
CEE 16A 3p	121	127	CEE 32A 5p	139	139
CEE 16A 4p	123	128			

Ref. no. 57092

Components:

4 Domestic sockets 16A, 230V ~
(type F - German standard)

Cable entry:

1x M25

Connection option:

for 1 cable up to 5 x 10 mm²



Ref. no. 57076

Components:

3 Domestic sockets 16A, 230V ~
(type F - German standard)
1 CEE socket 16A, 400V, 5p

Cable entry:

1x M25

Connection option:

for 1 cable up to 5 x 10 mm²



Ref. no. 57078

Components:

2 Domestic sockets 16A, 230V ~
(type F - German standard)
2 CEE sockets 16A, 400V, 5p

Cable entry:

1x M25

Connection option:

for 1 cable up to 5 x 10 mm²



Ref. no. 57117

Components:

2 Domestic sockets 16A, 230V ~
(type F - German standard)
2 CEE sockets 16A, 400V, 5p
1 compressed air connection:
Input: 1/2" pipe with external thread
Output: 1/2" quick-release connector

Cable entry:

1x M25

Connection option:

for 1 cable up to 5 x 10 mm²



Ref. no. 57116

Components:

3 Domestic sockets 16A, 230V ~
(type F - German standard)
1 CEE socket 16A, 400V, 5p
1 compressed air connection:
Input: 1/2" pipe with external thread
Output: 1/2" quick-release connector

Cable entry:

1x M25

Connection option:

for 1 cable up to 5 x 10 mm²



Ref. no. 57119

Components:

4 Domestic sockets 16A, 230V ~
(type F - German standard)
1 compressed air connection:
Input: 1/2" pipe with external thread
Output: 1/2" quick-release connector

Cable entry:

1x M25

Connection option:

for 1 cable up to 5 x 10 mm²



Technical information

- Wired ready for connection
- Protection degree IP44
- All distributors comply with the DIN EN 61439 / IEC 61439

Ref. no. **571121**

Components:

- 3 Domestic sockets 16A, 230V ~ (type F - German standard)
- 1 CEE socket 16A, 400V, 5p
- 1 compressed air connection
- Input: 1/2" hose connector NW 13 mm
- Output: 1/2" two-way quick-release connector

Cable entry:

2x M25 (2 circuits)

Connection option:

for 2 cables up to 5 x 10 mm²



Ref. no. **573395**

Components:

- 3 Domestic sockets 16A, 230V ~ (type F - German standard)
- 4 data sockets RJ45/ Cat. 6

Cable entry:

1x M25, 1x M32

Connection option:

for 1 cable up to 5 x 10 mm²



Ref. no. **57829**

Components:

- 2 Domestic sockets 16A, 230V ~ (type F - German standard)
- 1 CEE socket 16A, 400V, 5p

Protection:

1 RCCB 40/0.03A, 4p

Cable entry:

1x M25

Connection option:

for 1 cable up to 5 x 10 mm²



Ref. no. **57250**

Components:

- 2 Domestic sockets 16A, 230V ~ (type F - German standard)
- 1 CEE socket 16A, 400V, 5p
- 1 CEE socket 32A, 400V, 5p

Cable entry:

1x M25, 1x M32

Connection option:

for 2 cables up to 5 x 10 mm²



Ref. no. **576277**

Components:

- 3 Domestic sockets 16A, 230V ~ (type F - German standard)
- 1 Overvoltage protection 230 LA

Cable entry:

1x M20

Connection option:

for 1 cable up to 5 x 10 mm²



Ref. no. **57074**

Components:

- 4 CEE sockets 16A, 400V, 5p

Cable entry:

1x M25

Connection option:

for 1 cable up to 5 x 10 mm²



Ref. no. **571276**

Components:

- 3 Domestic sockets 16A, 230V ~ (type F - German standard)

Protection:

1 RCCB 40/0.03A, 4p

Cable entry:

1x M25

Connection option:

for 1 cable up to 5 x 10 mm²



Ref. no. **570531**

Components:

- 2 Domestic sockets 16A, 230V ~ (type F - German standard)
- 1 CEE socket 16A, 400V, 5p
- 1 empty space for data sockets

Cable entry:

2x M25

Connection option:

for 1 cable up to 5 x 10 mm²



1

2

3

4

5

6

7

Combinations

Solid-Rubber distributor, hanging

Technical information

- Wired ready for connection
- Protection degree IP44
- All distributors comply with the DIN EN 61439 / IEC 61439

Ref. no. **573143**

Components:

3 Domestic sockets 16A, 230V ~
(type F - German standard)
2 RJ45 CAT6a below operating window,
can be closed with the plugs plugged in

Cable entry:

2x M25

Connection option:

for 1 cable up to 5 x 10 mm²



Ref. no. **572301**

Components:

3 Domestic sockets 16A, 230V ~
(type F - German standard)
2 Potential equalisation plug

Cable entry:

1 x M16, 1 x M25

Connection option:

for 1 cable up to 5 x 10 mm²



Ref. no. **572238**

Components:

3 Domestic sockets 16A, 230V ~
(type F - German standard)
1 Emergency off

Cable entry:

1 x M20, 1 x M25

Connection option:

for 1 cable up to 5 x 10 mm²



Ref. no. **570451**

Components:

4 Domestic sockets 16A, 230V ~
(type F - German standard)

Protection:

1 RCCB 40/0.03A, 4p

Cable entry:

1x M20

Connection option:

for 1 cable up to 5 x 10 mm²



Ref. no. **576282**

Components:

4 Domestic sockets 16A, 230V ~
(type F - German standard)
2 RJ45 CAT6a below operating window,
can be closed with the plugs plugged in

Cable entry:

2 x M20
1 x M25 with multiple sealing insert

Connection option:

for 1 cable up to 5 x 10 mm²



Ref. no. **573151**

Components:

6 Domestic sockets 16A, 230V ~
(type F - German standard)
2 RJ45 CAT6a below operating window,
can be closed with the plugs plugged in

Cable entry:

2x M25

Connection option:

for 1 cable up to 5 x 10 mm²



Ref. no. **57360**

Components:

3 Domestic sockets 16A, 230V ~
(type F - German standard)
1 empty space for data sockets

Cable entry:

2x M25

Connection option:

for 1 cable up to 5 x 10 mm²



Ref. no. **571370**

Components:

2 Domestic sockets 16A, 230V ~
(type F - German standard)
with child protection
2 Laboratory sockets yellow/green, earth
potential

2 Laboratory sockets 2x blue and 2x red
DC extra-low voltage

2 Laboratory sockets yellow, AC
extra-low voltage

Cable entry:

4x M20

Connection option:

for 1 cable up to 3 x 10 mm²



- Dimension of the bollard: 1355 x 250 mm
- Made of robust, hot-dip galvanised steel enclosure
- Ideal for safe energy distribution outdoors
- Vandal-proof owing to internally hinged door
- Lockable door with cylinder lock
- Cable outlet in door allows locking in connected state
- Safe protection of fuse elements behind operating window
- Suitable for base mounting
- RAL 7016; other colours possible on request
- Concrete base: see page 260

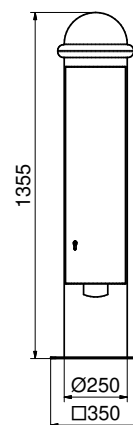

45 MB 19

Ref. no. **561090**

Components:

2 Domestic sockets 16A, 230V ~
(Type F - German standard)
1 CEE socket 16A, 400V, 5p
1 CEE socket 32A, 400V, 5p

Protection:

2 C-type MCBs 16A, 1p
1 C-type MCB 16A, 3p
1 C-type MCB 32A, 3p
1 RCCB 40/0.03A, 4p

Connection option:

for 2 cables up to 5 x 25 mm²



Ref. no. **562372**

Components:

2 Domestic sockets 16A, 230V ~
(Type F - German standard)
2 CEE sockets 16A, 400V, 5p

Protection:

2 C-type MCBs 16A, 1p
2 C-type MCBs 16A, 3p
1 RCCB 40/0.03A, 4p

Connection option:

for 2 cables up to 5 x 25 mm²



- Dimension of the bollard: 1120 x 273 mm
- Protection degree IP44
- Made of robust, hot-dip galvanised steel enclosure
- Ideal for safe energy distribution outdoors
- Vandal-proof owing to internally hinged door
- Lockable door with cylinder lock
- Cable outlet in door allows locking in connected state
- Suitable for base mounting
- RAL 7016; other colours possible on request
- Concrete base: see page 260

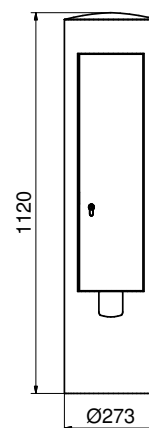

45 MB 74

Ref. no. **562389**

Components:

2 Domestic sockets 16A, 230V ~
(Type F - German standard)
1 CEE socket 16A, 400V, 5p

Protection:

2 C-type MCBs 16A, 1p
1 C-type MCB 16A, 3p
1 RCCB 40/0.03A, 4p

Cable entry:

2x M40

Connection option:

for 2 cables up to 5 x 25 mm²



Ref. no. **562390**

Components:

3 Domestic sockets 16A, 230V ~
(Type F - German standard)

Protection:

3 C-type MCBs 16A, 1p
1 RCCB 40/0.03A, 4p

Cable entry:

2x M40

Connection option:

for 1 cable up to 5 x 10 mm²



- Dimension of the bollard: 1120 x 324 mm
- Protection degree IP44
- Made of robust, hot-dip galvanised steel enclosure
- Ideal for safe energy distribution outdoors
- Vandal-proof owing to internally hinged door
- Lockable door with cylinder lock
- Cable outlet in door allows locking in connected state
- Suitable for base mounting
- RAL 7016; other colours possible on request
- Concrete base: see page 260

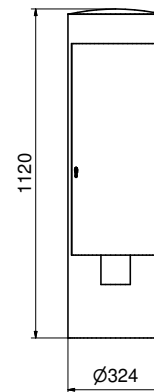

45 MB 73

Ref. no. **562391**

Components:

- 2 Domestic sockets 16A, 230V ~ (Type F - German standard)
- 1 CEE socket 16A, 400V, 5p
- 1 CEE socket 32A, 400V, 5p

Protection:

- 2 C-type MCBs 16A, 1p
- 1 C-type MCB 16A, 3p
- 1 C-type MCB 32A, 3p
- 1 RCCB 40/0.03A, 4p

Cable entry:

2x M40

Connection option:

for 2 cables up to 5 x 25 mm²



Ref. no. **562392**

Components:

- 2 Domestic sockets 16A, 230V ~ (Type F - German standard)
- 2 CEE sockets 16A, 400V, 5p

Protection:

- 2 C-type MCBs 16A, 1p
- 2 C-type MCBs 16A, 3p
- 1 RCCB 40/0.03A, 4p

Cable entry:

2x M40

Connection option:

for 2 cables up to 5 x 25 mm²



- Dimension of the bollard: 1420 x 420 mm
- Protection degree IP44
- Made of robust, hot-dip galvanised steel enclosure
- Ideal for safe energy distribution outdoors
- Vandal-proof owing to internally hinged door
- Lockable door with cylinder lock
- Cable outlet in door allows locking in connected state
- Suitable for base mounting
- RAL 7016; other colours possible on request
- Concrete base: see page 260

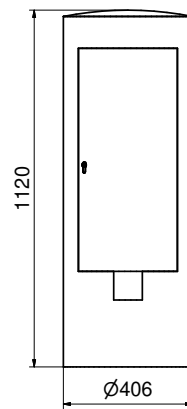

45 MB 75

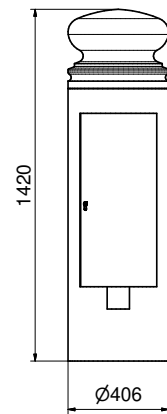

45 MB 39

Ref. no. **562366**

Components:

- 4 Domestic sockets 16A, 230V ~ (Type F - German standard)
- 1 CEE socket 16A, 400V, 5p
- 1 CEE socket 32A, 400V, 5p
- 1 CEE socket 63A, 400V, 5p

Protection:

- 4 C-type MCBs 16A, 1p
- 1 C-type MCB 16A, 3p
- 1 C-type MCB 32A, 3p
- 1 C-type MCB 63A, 3p
- 1 RCCB 63/0.03A, 4p

Cable entry:

2x M50

Connection option:

for 2 cables up to 5 x 25 mm²



Ref. no. **562393**

Components:

- 4 Domestic sockets 16A, 230V ~ (Type F - German standard)
- 2 CEE sockets 16A, 400V, 5p
- 1 CEE socket 32A, 400V, 5p

Protection:

- 4 C-type MCBs 16A, 1p
- 2 C-type MCBs 16A, 3p
- 1 C-type MCB 32A, 3p
- 1 RCCB 63/0.03A, 4p

Cable entry:

2x M40

Connection option:

for 2 cable up to 5 x 25 mm²



- Enclosure made of high-quality V2A stainless steel
- Brushed surface
- Door with box lock and single profile cylinder
- Wall mounting brackets, supplied loose
- Brush seal prevents dirt and dust from entering when door is closed
- Lockable in connected state
- Outgoing cables can be guided out through brush-sealed opening on front side
- Easy access to operating elements

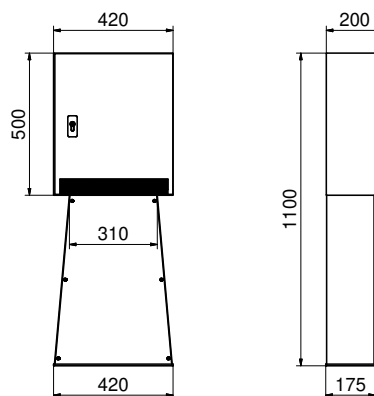

45 MB 18

Ref. no. **560030**

Components:

- 2 Domestic sockets 16A, 230V ~ (Type F - German standard)
- 1 CEE socket 16A, 400V, 5p
- 1 CEE socket 32A, 400V, 5p

Protection:

- 2 B-type MCBs 16A, 1p
- 1 C-type MCB 16A, 3p
- 1 C-type MCB 32A, 3p
- 1 RCCB 63/0,03A, 4p

Cable entry:

- 1 x M25, 1 x M32, 1 x M40

Connection option:

für 2 cables up to 5 x 25 mm²



Power-Port floor-standing distributor without door

- Housing made of high-quality V2A stainless steel
- Ground metal surface
- For VARIABOX and MODBOX-Midi
- Moveable panel for concealing cables
- Base plate suitable for pedestal mounting
- Available in different colours (optional)

Ref. no. **580589**

Mounting set for VARIABOX mounting
Order no. 581267

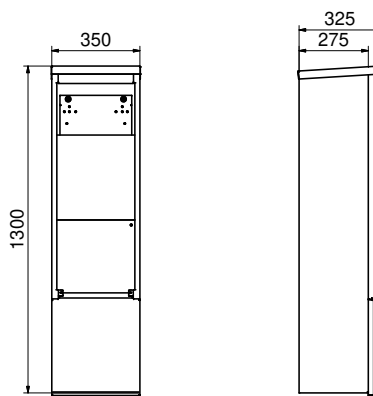

45 MB 59



Power-Port floor-standing distributor with door

- Housing made of high-quality V2A stainless steel
- Ground metal surface
- For VARIABOX and MODBOX-Midi
- Moveable panel for concealing cables
- Base plate suitable for pedestal mounting
- Door with box lock and single profile cylinder, internal hinges
- Brush seal prevents dirt and dust from entering when door is closed
- Outgoing cables can be guided out through brush-sealed opening on front side
- Available in different colours (optional)

Ref. no. **580508**

Mounting set for VARIABOX mounting
Order no. 581267

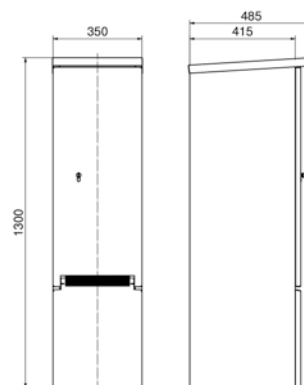

45 MB 55



Distributor Enclosure

- Made of high-grade, impact-resistant plastic
- Cover screws made of plastic
- Metric cable entry on request

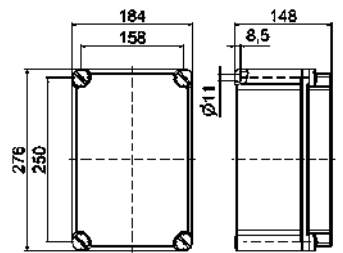

30 MB 121

Ref. no.

61133

Distributor Enclosure

- Made of high-grade, impact-resistant plastic
- Cover screws made of plastic
- Metric cable entry on request

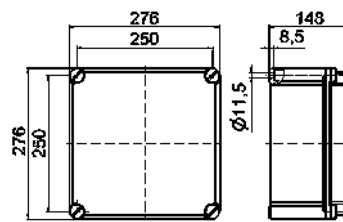

30 MB 122

Ref. no.

61134

Distributor Enclosure

- Made of high-grade, impact-resistant plastic
- With transparent hinged window
- 9 modules
- Cover screws made of plastic
- DIN rail
- Metric cable entry on request

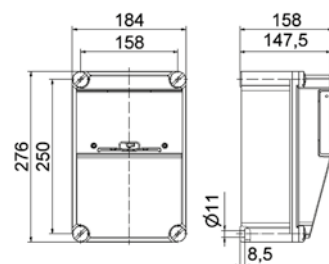

30 MB 145

Ref. no.

61402

Distributor Enclosure

- Made of high-grade, impact-resistant plastic
- Cover screws made of plastic
- Metric cable entry on request



6170

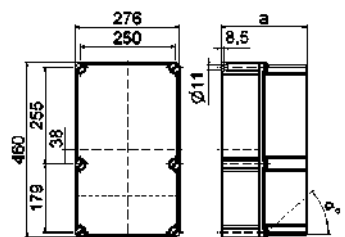

30 MB 98

a

Ref. no.

0° 148,0 **6171**

0° 228,0 **6170**

25° 228,0 **6173**

42° 228,0 **6172**

Distributor Enclosure

- Made of high-grade, impact-resistant plastic
- Cover screws made of plastic
- Metric cable entry on request



61101

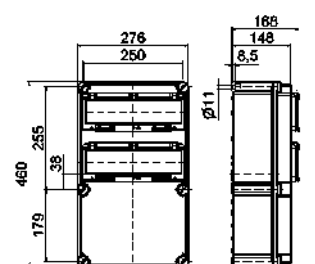

30 MB 137

Ref. no.

2 hinged windows **61101**

3 hinged windows **61128**

Pillar with protective rain canopy

- Housing made of high-quality V2A stainless steel
- Ground metal surface
- For VARIABOX S, M und L
- Base plate suitable for pedestal mounting
- Available in different colours (optional)

Ref. no. **580860**

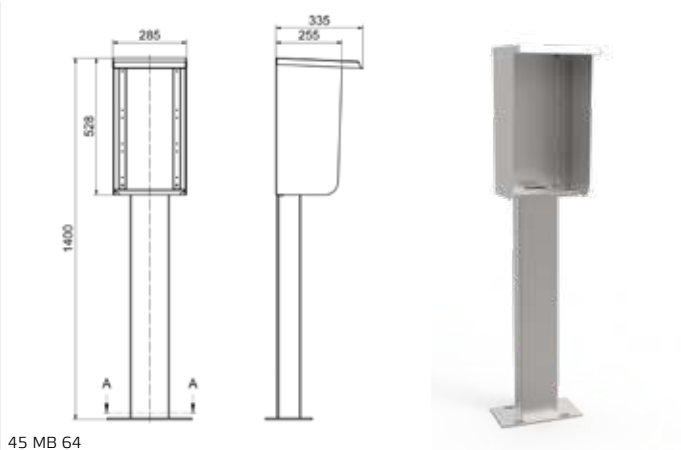

45 MB 64

1

Protective rain canopy

- Housing made of high-quality V2A stainless steel
- With side panels
- Ground metal surface
- Mounting plate for fitting VARIABOXES
- Available in RAL colours (optional)

Ref. no. **580511**

- for VARIABOX S,M,L
- Dimensions: 545 x 286 x 328 mm

Ref. no. **580529**

- for VARIABOX XL,XXL
- Dimensions: 792 x 286 x 328 mm

Ref. no. **580521**

- for VARIABOX L-DUO, XL-DUO
- Dimensions: 662 x 516 x 328 mm



2

3

Weather protection for EVOBOX distributor

- available for all EVOBOX sizes
- individually adapted to the distributor
- Black side walls, transparent front and back walls

On request



4

5

Concrete Base

- for ground/floor attachment for Power-Ports

Ref. no. **58370**



Ground Anchor

- for ground/floor attachment for Distribution bollards

Ref. no. **581323**

- for Distribution bollards $\varnothing 273\text{mm}$

Ref. no. **581324**

- for Distribution bollards $\varnothing 324\text{mm}$

Ref. no. **581325**

- for Distribution bollards $\varnothing 420\text{mm}$



6

7

Hinged Window

- Self-closing
- With protection against accidental contact
- In the case of hinged windows for use with DIN screws (order No. 58036), add -GWE to the end of the order number

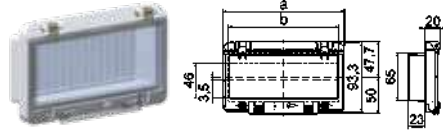

58009

30 MB 96

Module unit	Dimension a	Dimension b	Ref. no.
2	55,0	40,5	5881
4	91,0	76,5	5890
6	127,0	112,5	5899
8	162,0	147,5	58009
12	234,0	220,0	58018
13	257,5	248,5	58027

Hinged Window

- Self-closing
- Without protection against accidental contact
- In the case of hinged windows for use with DIN screws (order No. 58036), add -GWE to the end of the order number

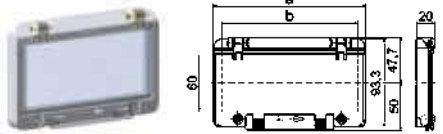

58010

30 MB 95

Module unit	Dimension a	Dimension b	Ref. no.
2	55,0	37,0	5882
4	91,0	73,0	5891
6	127,0	109,0	58001
8	162,0	144,5	58010
12	234,0	217,0	58019
13	257,5	240,0	58028

Hinged Window

- Self-closing
- With protection against accidental contact and mounting bracket
- In the case of hinged windows for use with DIN screws (order No. 58036), add -GWE to the end of the order number

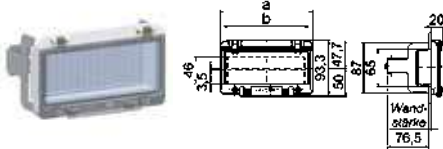

30 MB 97

Module unit	Dimension a	Dimension b	Ref. no.
2	55,0	40,5	5885
4	91,0	76,5	5894
6	127,0	112,5	58004
8	162,0	147,5	58013
12	234,0	220,0	58022
13	257,5	248,5	58031

Lock Set

- Protection against unauthorised use by means of retrofittable lock
- Can be installed in hinged window



Ref. no.

58037-BE

DIN Screws

- For additional locking device
- Retrofittable
- Can only be used in operating windows with order No.-GWE.



Ref. no.

58036

Cable gland

- Black
- Protection degreee IP67



Thread	Sealing range	Ref. no.
M12	3-6 mm	580647
M20	8-13 mm	580648
M25	11-17 mm	580649
M32	15-21 mm	580650
M40	19-28 mm	580651
Multiple sealing insert	für M25	2x8 mm 580652
	für M32	4x8 mm 580653
Sealing plug for multiple sealing insert		581273
Packaging unit 100 pieces		

Cable gland with pressure equalisation

The use of pressure equalisation cable glands allows the internal pressure to adjust to the ambient pressure. The type-tested protection degree of the enclosure is fully retained. Temperature fluctuations, intense sunlight, or a sudden change in weather can cause condensation to form in combination enclosures. Basically, condensation can form in all sealed solid-rubber distributors. The higher the protection degree is, the more likely the formation of condensation will be.

We therefore recommend, especially in the case of distributors with protection degree IP67, the use of pressure equalisation cable glands.

- Minimised condensation formation and therefore reduction in downtimes and time-consuming and expensive repair work
- No expensive and high-maintenance ventilation technology required
- No drip holes which reduce the level of protection
- With air ducts for pressure equalisation
- Black
- Protection degree IP67



Thread	Sealing range	Ref. no.
M20	6-13 mm	580656
M25	9-17 mm	580657
M32	13-21 mm	580658
M40	16-28 mm	580659

Mounting set

- For VARIABOX S - XL, MODBOX and MODBOX-Midi
- Consisting of:
 - 4 screws 6 x 60 mm
 - 4 screw anchors 8 x 51 mm

Ref. no. **580640**



- For VARIABOX XXL
- Consisting of:
 - 6 screws 6 x 60 mm
 - 6 screw anchors 8 x 51 mm

Ref. no. **580727**

Lock set

- For OTC window
- With long shackle and 2 keys

Ref. no. **580642**



Portable stand

- Hot-dip galvanised steel tubing
- Folding
- Weight 4 kg
- Dimensions: 350/570 x 780 x 540 mm (W x H x D)

Ref. no. **580643**
- For VARIABOX M, L, XL



Ref. no. **580721**
- For MODBOX and MODBOX-Midi

Hanging unit

- For VARIABOX M and L
- Colour yellow, RAL 1023

Ref. no. **580641**



Positioners

The positioner is an effective helper in the area of workplace ergonomics: it finally enables the simple, height-variable positioning of supply units. The smooth-running height adjustment facilitates an ergonomic provision of the power supply. The braking force can be simply adjusted using the adjustment screw located on the side. With this product, you can position the Bals power distributors even more easily and more flexibly in their application area. Simply lifting or pulling down is enough to individually adjust the height.

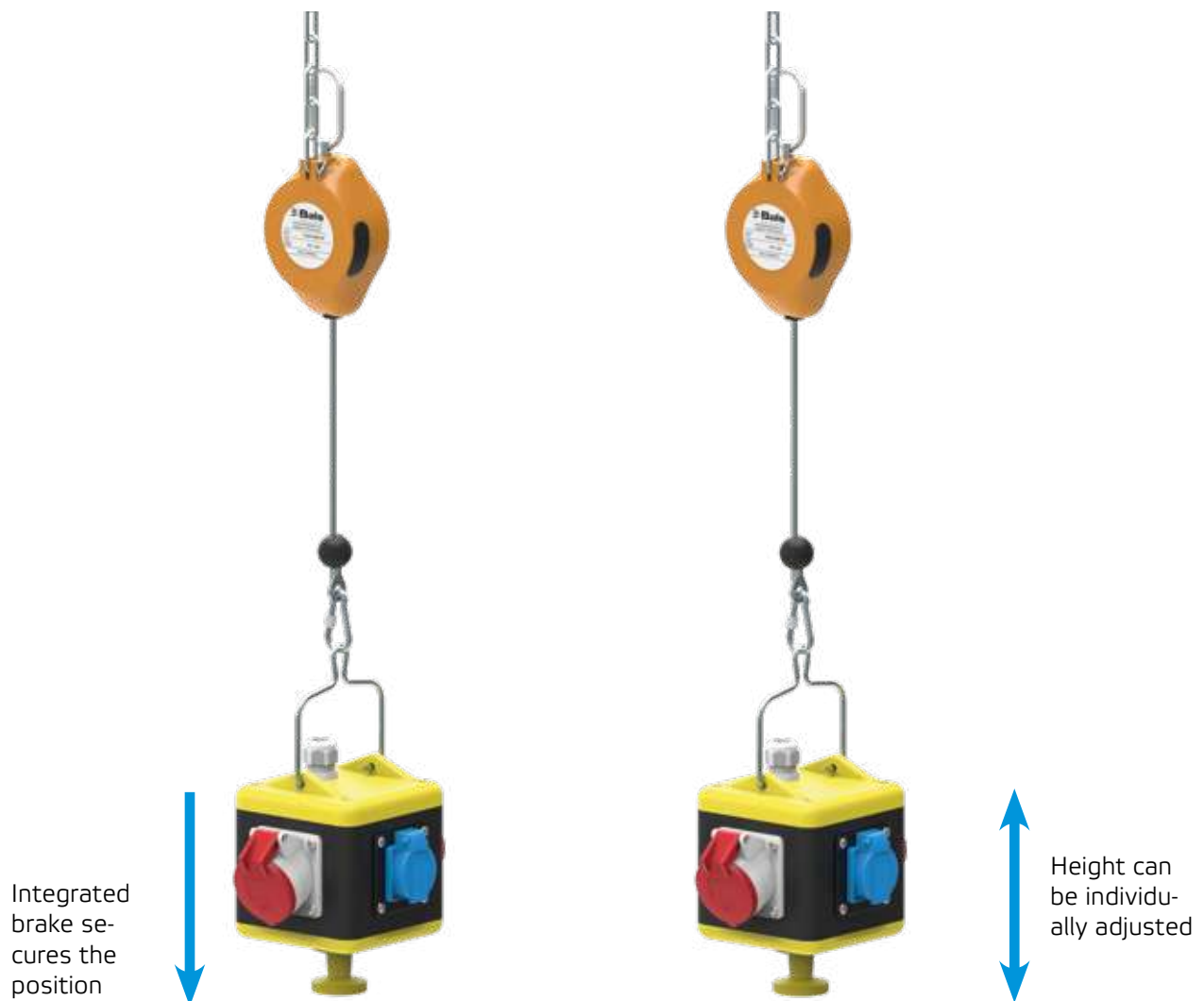

With the positioner, the risk of injury posed by hanging supply units is greatly minimised. Depending on the use, the height of the suspended unit can be conveniently varied. The integrated brake ensures that the position is securely held in place – even if the weight is changed, e.g., by plugging in or unplugging compressed air hoses. The housing, manufactured from a special plastic, is extremely impact resistant and is, thus, also suitable for use in very harsh production environments.



- 1 Safety suspension
- 2 Fall protection
- 3 Nameplate
- 4 Elastic cable stop buffer
- 5 Cover (adjustment screw for brake)
- 6 Load hook

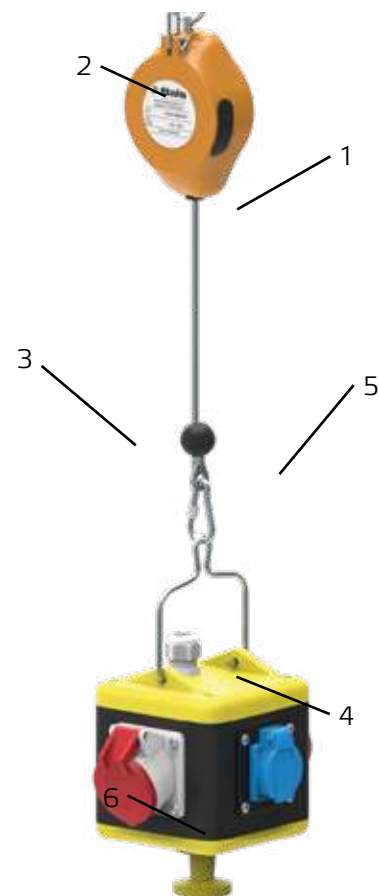

Version:

Housing made of extremely impact-resistant special plastic Load attached via secure screw-type spring hook Braking force adjustable via adjustment screw located on the side

Safety device:

- Fall protection equipped as standard
- Riveted special spring for retracting the suspension rope
- Isolated suspension
- Very dimensionally stable construction

Technical parameters:

- Net weight: 0.8 kg
- Cable travel: 1.5 meters

Ref. No. **581433**

- **Braking force: 2.0 - 7.0 kg**

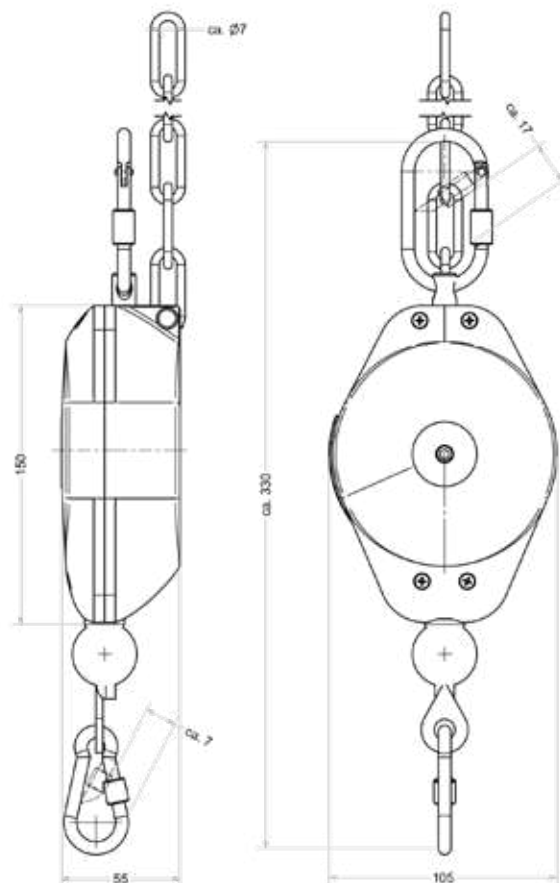





1

2

3

4

5

6

7

Plugs and Sockets 7-pole

Surface Mounting Socket Outlets  Pages 190 - 192	Panel Mounting Socket Outlets  Pages 190 - 191	Plugs / Inlets  Pages 190, 192 - 193	Connectors  Pages 191 - 192
---	---	---	---

Plugs and Sockets Special 1h Grounding Position

Surface Mounting Socket Outlets  Page 194	Panel Mounting Socket Outlets  Pages 194 - 195	Plugs / Inlets  Page 195	Connectors  Page 196
--	---	---	--

Plugs and Sockets Extra-Low Voltage

Surface Mounting Socket Outlets  Page 197	Panel Mounting Socket Outlets  Pages 197 - 198	Plugs / Inlets  Pages 198 - 199	Connectors  Page 199
---	--	--	--

Plugs and Sockets DC

Surface Mounting Socket Outlets  Pages 200 - 201	Panel Mounting Socket Outlets  Page 200	Plugs / Inlets  Pages 200 - 201	Connectors  Page 201
---	--	--	--

Plugs and Sockets 5h Grounding Position

Surface Mounting Socket Outlets  Page 202	Panel Mounting Socket Outlets  Pages 202 - 203	Plugs / Inlets  Page 203	Connectors  Page 204
--	---	---	--

High-Current Plugs and Sockets Above 125A

Surface Mounting Socket
Outlets



Page 205

Plugs / Inlets



Page 205

1

2

3

4

5

6

7

Special Plugs and Sockets

Plugs and sockets 7-pole

Technical information

- For plugs and sockets: polarity switchover circuits / star-delta circuit

Surface Mounting Socket Outlet TE

- Screw terminals
- High-temperature-resistant contact carrier
- Nickel plated contacts
- Cable entry 1x at top (open), 2x at bottom (closed)
- Base rotatable by 180°
- 4 mounting holes in enclosure base
- Protection degree IP44



11481

Ampere	6p+E Poles	230V	400V	Qty	each
		50-60 Hz	50-60 Hz		
16	7	11480	11481	10	375
32	7	11482	11483	10	455

Panel Mounting Socket Outlet TE

- Screw terminals
- High-temperature-resistant contact carrier
- Nickel plated contacts
- Flange 75 x 75 mm
- Protection degree IP44



13329

Ampere	6p+E Poles	230V	400V	Qty	each
		50-60 Hz	50-60 Hz		
16	7	13326	13327	10	195
32	7	13328	13329	10	270

Panel Mounting Socket Outlet TE

- Screw terminals
- 20° angled
- High-temperature-resistant contact carrier
- Nickel plated contacts
- Flange 100 x 92 mm
- Protection degree IP44



12393

Ampere	6p+E Poles	230V	400V	Qty	each
		50-60 Hz	50-60 Hz		
16	7	12390	12391	10	215
32	7	12392	12393	10	290

Plug TE with MULTI-GRIP

- Screw terminals
- High-temperature-resistant contact carrier
- Nickel plated contacts
- Special gland, simultaneous cable gland and seal
- Protection degree IP44



210067

Ampere	6p+E Poles	230V	400V	Qty	each
		50-60 Hz	50-60 Hz		
16	7	210550	21557	10	220
32	7	210636	210067	10	345

MULTI GRIP

Surface Mounting Appliance Inlet TE

- Screw terminals
- High-temperature-resistant contact carrier
- Nickel plated contacts
- Protection degree IP44



24196

Ampere	6p+E Poles	230V	400V	Qty	each
		50-60 Hz	50-60 Hz		
16	7	24193	24194	10	340
32	7	24195	24196	10	420

Technical information

- For plugs and sockets: polarity switchover circuits / star-delta circuit

Connector TE with MULTI-GRIP

- Screw terminals
- High-temperature-resistant contact carrier
- Nickel plated contacts
- Special gland, simultaneous cable gland and seal
- Protection degree IP44



MULTI GRIP

310123

Ampere	6p+E Poles	230V	400V	Qty	each
		50-60 Hz	50-60 Hz		
16	7	310311	31752	10	250
32	7	310381	310123	10	395

Surface Mounting Socket Outlet TE

- Screw terminals
- High-temperature-resistant contact carrier
- Nickel plated contacts
- Protection degree IP67



11542

Ampere	6p+E Poles	230V	400V	Qty	each
		50-60 Hz	50-60 Hz		
16	7	11634	11542	1	495

Surface Mounting Socket Outlet TE

- Screw terminals
- High-temperature-resistant contact carrier
- Nickel plated contacts
- Protection degree IP67



11714

Ampere	6p+E Poles	230V	400V	Qty	each
		50-60 Hz	50-60 Hz		
32	7	11635	11714	1	875

Panel Mounting Socket Outlet TE

- Screw terminals
- High-temperature-resistant contact carrier
- Nickel plated contacts
- Flange 75 x 75 mm
- Protection degree IP67



13333

Ampere	6p+E Poles	230V	400V	Qty	each
		50-60 Hz	50-60 Hz		
16	7	13330	13331	10	230
32	7	13332	13333	10	320

Panel Mounting Socket Outlet TE

- Screw terminals
- 20° angled
- High-temperature-resistant contact carrier
- Nickel plated contacts
- Flange 100 x 92 mm
- Protection degree IP67



12397

Ampere	6p+E Poles	230V	400V	Qty	each
		50-60 Hz	50-60 Hz		
16	7	12394	12395	10	245
32	7	12396	12397	10	335

1

2

3

4

5

6

7

Special Plugs and Sockets

Plugs and sockets 7-pole

Technical information

- For plugs and sockets: polarity switchover circuits / star-delta circuit

Plug TE with MULTI-GRIP

- Screw terminals
- High-temperature-resistant contact carrier
- Nickel plated contacts
- Special gland, simultaneous cable gland and seal
- Protection degree IP67



MULTI GRIP

21669

Ampere	6p+E Poles	230V 50-60 Hz	400V 50-60 Hz	Qty	each
		7pol 9h	7pol 6h		
16	7	21711	21667	10	255
32	7	21712	21669	10	405

Connector TE with MULTI-GRIP

- Screw terminals
- High-temperature-resistant contact carrier
- Nickel plated contacts
- Special gland, simultaneous cable gland and seal
- Protection degree IP67



MULTI GRIP

31515

Ampere	6p+E Poles	230V 50-60 Hz	400V 50-60 Hz	Qty	each
		7pol 9h	7pol 6h		
16	7	31512	31513	10	295
32	7	31514	31515	10	465

Surface Mounting Socket Outlet TE

- High-temperature-resistant contact carrier
- Nickel plated contacts
- Switched
- Lockable in 0-position
- Protection degree IP44



16374

Ampere	6p+E Poles	230V 50-60 Hz	400V 50-60 Hz	Qty	each
		7pol 9h	7pol 6h		
16	7	16441	16374	1	1105

Surface Mounting Socket Outlet TE

- High-temperature-resistant contact carrier
- Nickel plated contacts
- Switched
- With mechanical double interlocking
- Lockable in 0-position
- Protection degree IP44



16378

Ampere	6p+E Poles	230V 50-60 Hz	400V 50-60 Hz	Qty	each
		7pol 9h	7pol 6h		
16	7	16445	16378	1	220
32	7		160438	1	345

Surface Mounting Socket Outlet TE

- High-temperature-resistant contact carrier
- Nickel plated contacts
- Switched
- With mechanical double interlocking
- Lockable in 0-position
- Protection degree IP67



16380

Ampere	6p+E Poles	230V 50-60 Hz	400V 50-60 Hz	Qty	each
		7pol 9h	7pol 6h		
16	7	16447	16380	1	1120
32	7		160087	1	1975

Technical information

- For plugs and sockets: polarity switchover circuits / star-delta circuit

Panel Mounting Appliance Inlet TE

- Screw terminals
- High-temperature-resistant contact carrier
- Nickel plated contacts
- Protection degree IP44



26002

Ampere	6p+E Poles	230V	400V	Qty	each
		50-60 Hz	50-60 Hz		
16	7	26012	26013	10	200
32	7	26001	26002	10	300

Panel Mounting Appliance Inlet TE

- Screw terminals
- High-temperature-resistant contact carrier
- Nickel plated contacts
- Protection degree IP67



26006

Ampere	6p+E Poles	230V	400V	Qty	each
		50-60 Hz	50-60 Hz		
16	7	26003	26004	10	275
32	7	26005	26006	10	350

Panel Mounting Appliance Inlet TE

- Screw terminals
- High-temperature-resistant contact carrier
- Nickel plated contacts
- Protection degree IP67



27120

Ampere	6p+E Poles	230V	400V	Qty	each
		50-60 Hz	50-60 Hz		
16	7	27117	27118	10	240
32	7	27119	27120	10	410

1

2

3

4

5

6

7

Special Plugs and Sockets

Plugs and sockets 1h grounding position

Technical information

- IEC 60309, EN 60309, VDE 0623

Surface Mounting Socket Outlet QUICK-CONNECT TE

- Screwless terminals
- Kontex contact
- Nickel plated contacts
- Cable entry 1x at top (open) and 1x at bottom (closed) for 16A 3p
- Cable entry 1x at top (open), 2x at bottom (closed) for 16A 4p - 32A 5p
- Base rotatable by 180°
- Protection degree IP44



110579

QUICK CONNECT

		>50 - 500V				
2P+N-E Ampere	3P+N-E Poles	3pol 1h	4pol 1h	5pol 1h	Qty	Each
16	3	110577	10	185		
16	4	110353	10	305		
16	5	110394	10	330		
32	4	110578	10	370		
32	5	110579	10	380		

Surface Mounting Socket Outlet TE

- Cable entry 1x at top (open), 2x at bottom (closed) for 63A
- Cable entry M50 from above for 125A
- Base rotatable by 180° for 63A
- High-temperature-resistant contact carrier
- Kontex contact
- Box terminals
- Nickel plated contacts
- Protection degree IP44 for 63A, IP67 for 125A



11889



110140

		>50 - 500V				
2P+N-E Ampere	3P+N-E Poles	3pol 1h	4pol 1h	5pol 1h	Qty	Each
63	5	11889	5	825		
125	5	110140	1	2085		

Panel Mounting Socket Outlet QUICK-CONNECT TE

- Screwless terminals
- High-temperature-resistant contact carrier
- Kontex contact
- Nickel plated contacts
- Flange 75 x 75 mm
- Protection degree IP44



130278

QUICK CONNECT

		>50 - 500V				
2P+N-E Ampere	3P+N-E Poles	3pol 1h	4pol 1h	5pol 1h	Qty	Each
16	3	130277	10	110		
16	4	130077	10	130		
16	5	130278	10	170		
32	4	130040	10	205		
32	5	13822	10	225		

Panel Mounting Socket Outlet TE

- Screw terminals
- Flange 107 x 100 for 63A
- Flange 120 x 120 for 125A
- High-temperature-resistant contact carrier
- Kontex contact
- Box terminals
- Nickel plated contacts
- Protection degree IP44 for 63A, IP67 for 125A



130279



13613

		>50 - 500V				
2P+N-E Ampere	3P+N-E Poles	3pol 1h	4pol 1h	5pol 1h	Qty	Each
63	5	130279	5	530		
125	5	13613	5	1125		

Panel Mounting Socket Outlet QUICK-CONNECT TE

- Screwless terminals
- 20° angled
- High-temperature-resistant contact carrier
- Kontex contact
- Nickel plated contacts
- Flange 85 x 85 mm
- Protection degree IP44



120256

QUICK CONNECT

		>50 - 500V				
2P+N-E Ampere	3P+N-E Poles	3pol 1h	4pol 1h	5pol 1h	Qty	Each
16	3	120442	10	125		
16	4	120150	10	145		
16	5	120282	10	175		
32	4	120157	10	235		
32	5	120256	10	265		

Technical information

- IEC 60309, EN 60309, VDE 0623

Panel Mounting Socket Outlet TE

- Screw terminals
- 15° angled
- Flange 114 x 114 mm
- High-temperature-resistant contact carrier
- Kontex contact
- Box terminals
- Nickel plated contacts
- Protection degree IP44 for 63A, IP67 for 125A



120280

12689

2P+E Ampere	3P+E Poles	3+N+E Poles	>50 - 500V	3pol 1h	4pol 1h	5pol 1h	Qty	g	Each
63	5		120280				5	665	
125	5		12689				5	980	

Plug TE-Plus with MULTI-GRIP

- Screwless terminals
- High-temperature-resistant contact carrier
- Nickel plated contacts
- Special gland, simultaneous cable gland and seal
- Protection degree IP44



21907

2P+E Ampere	3P+E Poles	3+N+E Poles	>50 - 500V	3pol 1h	4pol 1h	5pol 1h	Qty	g	Each
16	3		210402				10	125	
16	4		210668				10	145	
16	5		21907				10	180	
32	4		210358				10	260	
32	5		210238				10	295	

QUICK CONNECT
MULTI GRIP

Plug TE with MULTI-GRIP

- Screw terminal
- Box terminals
- High-temperature-resistant contact carrier
- Nickel plated contacts
- Special gland, simultaneous cable gland and seal
- Protection degree IP44 for 63A, IP67 for 125A



21785

21966

2P+E Ampere	3P+E Poles	3+N+E Poles	>50 - 500V	3pol 1h	4pol 1h	5pol 1h	Qty	g	Each
63	5		21785				5	655	
125	5		21966				5	1235	

MULTI GRIP

Surface Mounting Appliance Inlet QUICK-CONNECT TE

- Screwless terminals
- High-temperature-resistant contact carrier
- Nickel plated contacts
- Cable entry 1x at top (open), 2x at bottom (closed)
- Base rotatable by 180°
- 4 mounting holes in enclosure base
- Suitable for through wiring
- Protection degree IP44



24625

2P+E Ampere	3P+E Poles	3+N+E Poles	>50 - 500V	3pol 1h	4pol 1h	5pol 1h	Qty	g	Each
16	5		24625				10	305	
32	4		24626				10	380	
32	5		24627				10	385	

QUICK CONNECT

Surface Mounting Appliance Inlet TE

- Screw terminals
- Box terminals
- Cable entry 1x at top (open) and 2x at bottom (closed) for 63A
- Cable entry M50 from above for 125A
- Base rotatable by 180° for 63A
- High-temperature-resistant contact carrier
- Nickel plated contacts
- Protection degree IP44 for 63A, IP67 for 125A



24594

24241

2P+E Ampere	3P+E Poles	3+N+E Poles	>50 - 500V	3pol 1h	4pol 1h	5pol 1h	Qty	g	Each
63	5		24594				5	1020	
125	5		24241				1	1235	

Special Plugs and Sockets

Plugs and sockets 1h grounding position

Technical information

- IEC 60309, EN 60309, VDE 0623

Connector TE-Plus with MULTI-GRIP

- Screwless terminals
- High-temperature-resistant contact carrier
- Kontex contact
- Nickel plated contacts
- Special gland, simultaneous cable gland and seal
- Protection degree IP44



310044

QUICK CONNECT
MULTI GRIP

		>50 - 500V				g	
2P+E Ampere	3P+E Poles	3+N+E Poles	3pol 1h	4pol 1h	5pol 1h	Qty	Each
16	3		310564			10	145
16	4		310519			10	170
16	5		310068			10	200
32	4		31779			10	310
32	5		310044			10	340

Connector TE with Multi-Grip

- Screw terminal
- Box terminals
- High-temperature-resistant contact carrier
- Kontex contact
- Nickel plated contacts
- Protection degree IP44 for 63A, IP67 for 125A



31627

MULTI GRIP

		>50 - 500V				g	
2P+E Ampere	3P+E Poles	3+N+E Poles	3pol 1h	4pol 1h	5pol 1h	Qty	Each
63	5		31627			5	670
125	5		31641			5	1300

31641

Surface Mounting Socket Outlet

- Screw terminals
- Cable entry 1x at top (open)
- Protection degree IP44



4118

Ampere	Poles	24V	42V	100-200Hz	300Hz	400Hz	up to 50V	Qty	Each
		50-60 Hz	50-60 Hz	up to 50V	up to 50V	up to 50V			
16	2	410	411	412	413	414	415	10	180
16	3	416	417	418	419	4110	4107	10	195
32	2	4111	4112	4113	4114	4115	4116	10	180
32	3	4117	4118	4119	4120	4121	4157	10	195

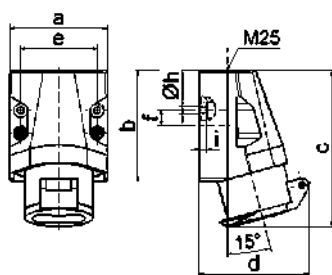

16 MB 11

Ampere	16	16	32	32
Poles	2	3	2	3
a	70,0	70,0	70,0	70,0
b	80,0	80,0	80,0	80,0
c	113,0	113,0	113,0	113,0
d	80,0	80,0	80,0	80,0
e	55,0	55,0	55,0	55,0
f	11,0	11,0	11,0	11,0
ø h	5,2	5,2	5,2	5,2
i	5,0	5,0	5,0	5,0
Cond. mm² min	4	4	4	4
Cond. mm² max	10	10	10	10

Panel Mounting Socket Outlet

- Screw terminals
- Straight
- Flange 55 x 55 mm
- Protection degree IP44



4318

Ampere	Poles	24V	42V	100-200Hz	300Hz	400Hz	up to 50V	Qty	Each
		50-60 Hz	50-60 Hz	up to 50V	up to 50V	up to 50V			
16	2	430	431	432	433	434	435	10	110
16	3	436	437	438	439	4310	4390	10	125
32	2	4311	4312	4313	4314	4315	4316	10	110
32	3	4317	4318	4319	4320	4321		10	125

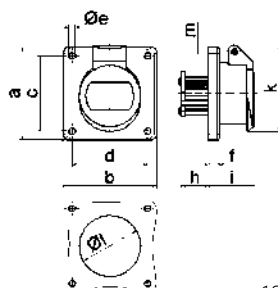

16 MB 13

Ampere	16	16	32	32
Poles	2	3	2	3
a	55,0	55,0	55,0	55,0
b	55,0	55,0	55,0	55,0
c	45,0	45,0	45,0	45,0
d	45,0	45,0	45,0	45,0
ø e	5,2	5,2	5,2	5,2
f	6,0	6,0	6,0	6,0
h	22,0	22,0	22,0	22,0
i	37,0	37,0	37,0	37,0
k	67,0	67,0	67,0	67,0
ø l	49,0	49,0	49,0	49,0
m	12,0	12,0	12,0	12,0
Cond. mm² min	4	4	4	4
Cond. mm² max	10	10	10	10

Panel Mounting Socket Outlet

- Screw terminals
- Straight
- Flange 75 x 75 mm
- Protection degree IP44



4372

Ampere	Poles	24V	42V	100-200Hz	300Hz	400Hz	up to 50V	Qty	Each
		50-60 Hz	50-60 Hz	up to 50V	up to 50V	up to 50V			
16	2	4354	4355	4356	4357	4358	4359	10	130
16	3	4360	4361	4362	4363	4364	43003	10	150
32	2	4365	4366	4367	4368	4369	4370	10	130
32	3	4371	4372	4373	4374	4375		10	150

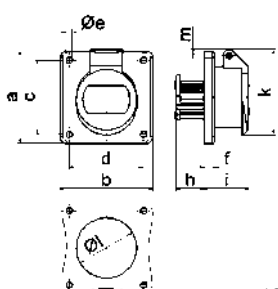

16 MB 13

Ampere	16	16	32	32
Poles	2	3	2	3
a	75,0	75,0	75,0	75,0
b	75,0	75,0	75,0	75,0
c	60,0	60,0	60,0	60,0
d	60,0	60,0	60,0	60,0
ø e	5,2	5,2	5,2	5,2
f	6,0	6,0	6,0	6,0
h	22,0	22,0	22,0	22,0
i	37,0	37,0	37,0	37,0
k	67,0	67,0	67,0	67,0
ø l	49,0	49,0	49,0	49,0
m	2,0	2,0	2,0	2,0
Cond. mm² min	4	4	4	4
Cond. mm² max	10	10	10	10

Panel Mounting Socket Outlet

- Screw terminals
- 20° angled
- Flange 68 x 62 mm
- Protection degree IP44



4218

Ampere	Poles	24V 50-60 Hz	42V 50-60 Hz	100-200Hz up to 50V	300Hz up to 50V	400Hz up to 50V	up to 50V	Qty	Each
		12h	4h	2h	3h	10h			
16	2	420	421	422	423	424	425	10	115
16	3	426	427	428	429	4210		10	135
32	2	4211	4212	4213	4214	4215	4216	10	115
32	3	4217	4218	4219	4220	4221	4274	10	135

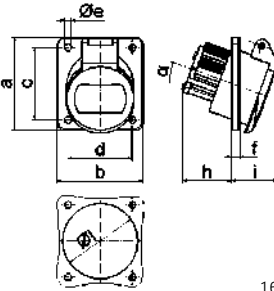

16 MB 12

Ampere Poles	16 2	16 3	32 2	32 3
a	68,0	68,0	68,0	68,0
b	62,0	62,0	62,0	62,0
c	53,0	53,0	53,0	53,0
d	47,0	47,0	47,0	47,0
ø e	5,2	5,2	5,2	5,2
f	6,0	6,0	6,0	6,0
h	36,0	36,0	36,0	36,0
i	35,0	35,0	35,0	35,0
α	20°	20°	20°	20°
ø l	55,0	55,0	55,0	55,0
Cond. mm² min	4	4	4	4
Cond. mm² max	10	10	10	10

Panel Mounting Socket Outlet

- Screw terminals
- 20° angled
- Flange 100 x 92 mm
- Protection degree IP44



4240

Ampere	Poles	24V 50-60 Hz	42V 50-60 Hz	100-200Hz up to 50V	300Hz up to 50V	400Hz up to 50V	up to 50V	Qty	Each
		12h	4h	2h	3h	10h			
16	2	4222	4223	4224	4225	4226	4227	10	150
16	3	4228	4229	4230	4231	4232		10	165
32	2	4233	4234	4235	4236	4237	4238	10	150
32	3	4239	4240	4241	4242	4243		10	165

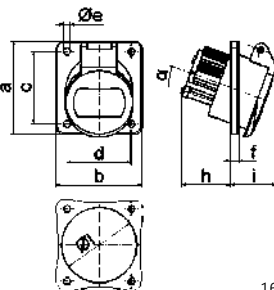

16 MB 48

Ampere Poles	16 2	16 3	32 2	32 3
a	100,0	100,0	100,0	100,0
b	92,0	92,0	92,0	92,0
c	85,0	85,0	85,0	85,0
d	77,0	77,0	77,0	77,0
ø e	5,2	5,2	5,2	5,2
f	6,0	6,0	6,0	6,0
h	36,0	36,0	36,0	36,0
i	35,0	35,0	35,0	35,0
α	20°	20°	20°	20°
ø l	55,0	55,0	55,0	55,0
Cond. mm² min	4	4	4	4
Cond. mm² max	10	10	10	10

Surface Mounting Socket Outlet

- Screw terminals
- Protection degree IP44



4619

Ampere	Poles	24V 50-60 Hz	42V 50-60 Hz	100-200Hz up to 50V	300Hz up to 50V	400Hz up to 50V	up to 50V	Qty	Each
		12h	4h	2h	3h	10h			
16	2	460	461	462	463	464	465	10	140
16	3	466	467	468	469	4610		10	165
32	2	4611	4612	4613	4614	4615	4616	10	140
32	3	4617	4618	4619	4620	4621		10	165

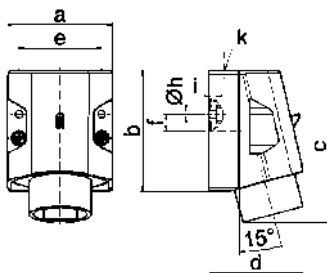

16 MB 15

Ampere Poles	16 2	16 3	32 2	32 3
a	70,0	70,0	70,0	70,0
b	80,0	80,0	80,0	80,0
c	100,0	100,0	100,0	100,0
d	82,0	82,0	82,0	82,0
e	55,0	55,0	55,0	55,0
f	11,0	11,0	11,0	11,0
ø h	5,2	5,2	5,2	5,2
i	5,0	5,0	5,0	5,0
k	M25	M25	M25	M25
Cond. mm² min	4	4	4	4
Cond. mm² max	10	10	10	10

Technical information

- IEC 60309, VDE 0623

Plug with MULTI-GRIP

- Screw terminals
- Nickel plated contacts
- Special gland, simultaneous cable gland and seal
- Protection degree IP44

MULTI GRIP



4441

Ampere	Poles	24V 50-60 Hz	42V 50-60 Hz	100-200Hz up to 50V	300Hz up to 50V	400Hz up to 50V	up to 50V	Qty	Each
		---	12h	4h	2h	3h	10h		
16	2	4422	4423	4424	4425	4426	4427	10	125
16	3	4428	4429	4430	4431	4432	4481	10	160
32	2	4433	4434	4435	4436	4437	4438	10	125
32	3	4439	4440	4441	4442	4443		10	160

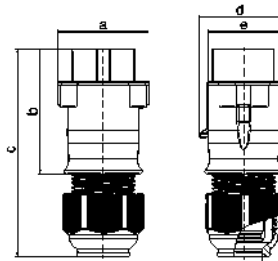

16 MB 43

Ampere	16	16	32	32
Poles	2	3	2	3
a	62,0	62,0	62,0	62,0
b	85,0	85,0	85,0	85,0
c	140,0	140,0	140,0	140,0
d	55,0	55,0	55,0	55,0
e	50,0	50,0	50,0	50,0
a f	24,5	24,5	24,5	24,5
Cond. mm ² min	4	4	4	4
Cond. mm ² max	10	10	10	10

Connector with MULTI-GRIP

- Screw terminals
- Nickel plated contacts
- Special gland, simultaneous cable gland and seal
- Protection degree IP44

MULTI GRIP



4541

Ampere	Poles	24V 50-60 Hz	42V 50-60 Hz	100-200Hz up to 50V	300Hz up to 50V	400Hz up to 50V	up to 50V	Qty	Each
		---	12h	4h	2h	3h	10h		
16	2	4522	4523	4524	4525	4526	4527	10	185
16	3	4528	4529	4530	4531	4532	45044	10	205
32	2	4533	4534	4535	4536	4537	4538	10	185
32	3	4539	4540	4541	4542	4543		10	205

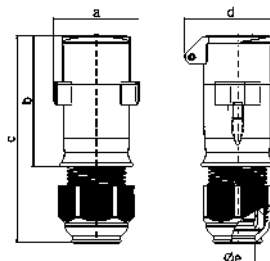

16 MB 44

Ampere	16	16	32	32
Poles	2	3	2	3
a	62,0	62,0	62,0	62,0
b	96,0	96,0	96,0	96,0
c	152,0	152,0	152,0	152,0
d	67,0	67,0	67,0	67,0
ø e	24,5	24,5	24,5	24,5
Cond. mm ² min	4	4	4	4
Cond. mm ² max	10	10	10	10

Reducer

- Suitable for cables less than Ø 8 mm
- For all 16A standard plugs and sockets with Multi-Grip as well as extra-low voltage



Ref. no.

29129

Surface Mounting Socket Outlet

- Screw terminals
- Protection degree IP44

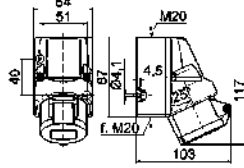

1 MB 35

Amperage	2p+E Poles	>50V up to 250V	>250V	Qty	g
		3pol 3h	3pol 8h		
16	3	11032		10	200

Panel Mounting Socket Outlet

- Screw terminals
- Straight
- Protection degree IP44

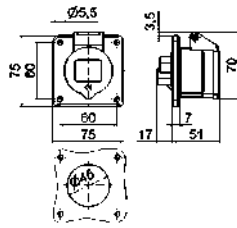

4 MB 74

Amperage	2p+E Poles	>50V up to 250V	>250V	Qty	g
		3pol 3h	3pol 8h		
16	3	13070		10	120

Panel Mounting Socket Outlet

- Screw terminals
- Angled
- Protection degree IP44

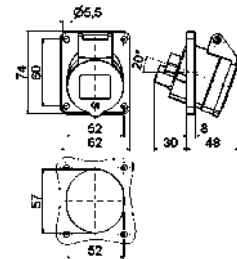

4 MB 73

Amperage	2p+E Poles	>50V up to 250V	>250V	Qty	g
		3pol 3h	3pol 8h		
16	3	12144		10	130

Plug TE-Plus with MULTI-GRIP

- Screwless terminals
- High-temperature-resistant contact carrier
- Nickel plated contacts
- Special gland, simultaneous cable gland and seal
- Protection degree IP44

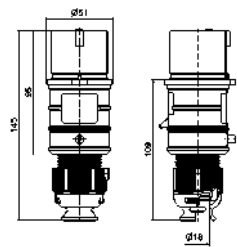

21868

2 MB 220

Amperage	2p+E Poles	>50V up to 250V	>250V	Qty	g
		3pol 3h	3pol 8h		
16	3	21868	21882	10	125

Plug TE-Plus with MULTI-GRIP

- Screwless terminals
- High-temperature-resistant contact carrier
- Nickel plated contacts
- Special gland, simultaneous cable gland and seal
- Protection degree IP44

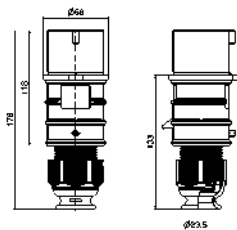

21869

2 MB 221

Amperage	2p+E Poles	>50V up to 250V	>250V	Qty	g
		3pol 3h	3pol 8h		
32	3	21869	21876	10	240

QUICK CONNECT
MULTI GRIP

QUICK CONNECT
MULTI GRIP

Plug TE with MULTI-GRIP

- Screw terminals
- Nickel plated contacts
- Screwless enclosure connection, self locking
- Special gland, simultaneous cable gland and seal
- Protection degree IP44

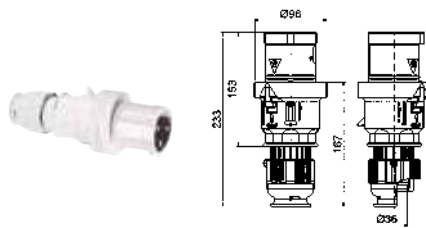

2 MB 226

MULTI GRIP

Ampere	2p+E Poles	>50V up to 250V	>250V	Qty	Each
		3pol 3h	3pol 8h		
63	3	21706		5	535

Connector TE-Plus with MULTI-GRIP

- Screwless terminals
- High-temperature-resistant contact carrier
- Nickel plated contacts
- Special gland, simultaneous cable gland and seal
- Protection degree IP44

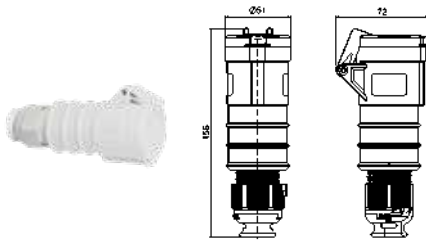

3 MB 123

QUICK CONNECT MULTI GRIP

Ampere	2p+E Poles	>50V up to 250V	>250V	Qty	Each
		3pol 3h	3pol 8h		
16	3	31677		10	145

Surface Mounting Socket Outlet

- Screw terminals
- Nickel plated contacts
- Switched
- With mechanical double interlocking
- Lockable in 0-position
- Protection degree IP44

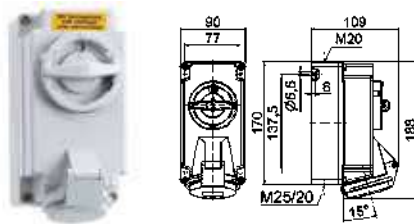

12 MB 29

Ampere	2p+E Poles	>50V up to 250V	>250V	Qty	Each
		3pol 3h	3pol 8h		
16	3	16449		1	575

Surface Mounting Socket Outlet

- Screw terminals
- Nickel plated contacts
- Switched
- With mechanical double interlocking
- Lockable in 0-position
- Protection degree IP44

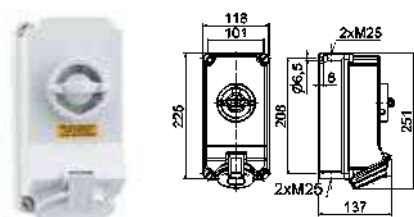

12 MB 28

Ampere	2p+E Poles	>50V up to 250V	>250V	Qty	Each
		3pol 3h	3pol 8h		
32	3	16450		1	1215

Special Plugs and Sockets

Plugs and sockets 5h grounding position

Technical information

- IEC 60309, EN 60309, VDE 0623

Surface Mounting Socket Outlet QUICK-CONNECT TE

- Screwless terminals
- Cable entry 1x at top (open), 2x at bottom (closed)
- Base rotatable by 180°
- High-temperature-resistant contact carrier
- Kontex contact
- Nickel plated contacts
- Protection degree IP44



110582

Amperere	Poles	600-690V 50 + 60Hz		Qty	Each
		4pol 5h	5pol 5h		
16	4	110580	10	315	
16	5	110581	10	330	
32	4	110481	10	380	
32	5	110582	10	380	

QUICK CONNECT

Surface Mounting Socket Outlet TE

- Cable entry 1x at top (open), 2x at bottom (closed) for 63A
- Base rotatable by 180° for 63A
- Cable entry 1x M50 from above for 125A
- High-temperature-resistant contact carrier
- Kontex contact
- Box terminals
- Nickel plated contacts
- Protection degree IP44 for 63A, IP67 for 125A



110583



110328

Amperere	Poles	600-690V 50 + 60Hz		Qty	Each
		4pol 5h	5pol 5h		
63	4	11334	5	795	
63	5	110583	5	830	
125	4	11019	1	1975	
125	5	110328	1	2085	

Panel Mounting Socket Outlet QUICK-CONNECT TE

- Screwless terminals
- High-temperature-resistant contact carrier
- Kontex contact
- Nickel plated contacts
- Flange 75 x 75 mm
- Protection degree IP44



130283

Amperere	Poles	600-690V 50 + 60Hz		Qty	Each
		4pol 5h	5pol 5h		
16	4	130280	10	150	
16	5	130281	10	170	
32	4	130282	10	230	
32	5	130283	10	250	

QUICK CONNECT

Panel Mounting Socket Outlet TE

- Screw terminals
- Flange 107 x 100 for 63A
- Flange 120 x 120 for 125A
- High-temperature-resistant contact carrier
- Kontex contact
- Box terminals
- Nickel plated contacts
- Protection degree IP44 for 63A, IP67 for 125A



13849



130055

Amperere	Poles	600-690V 50 + 60Hz		Qty	Each
		4pol 5h	5pol 5h		
63	4	13075	5	445	
63	5	13849	5	490	
125	4	130232	5	1005	
125	5	130055	5	1110	

Panel Mounting Socket Outlet QUICK-CONNECT TE

- Screwless terminals
- 20° angled
- High-temperature-resistant contact carrier
- Kontex contact
- Nickel plated contacts
- Flange 85 x 85 mm
- Protection degree IP44



120277

Amperere	Poles	600-690V 50 + 60Hz		Qty	Each
		4pol 5h	5pol 5h		
16	4	120368	10	135	
16	5	120275	10	150	
32	4	120336	10	200	
32	5	120277	10	245	

QUICK CONNECT

Technical information

- IEC 60309, EN 60309, VDE 0623

Panel Mounting Socket Outlet TE

- Screw terminals
- 15° angled
- Flange 114 x 114 mm
- High-temperature-resistant contact carrier
- Kontex contact
- Box terminals
- Nickel plated contacts
- Protection degree IP44 for 63A, IP67 for 125A



12251

12065

Amperes	Poles	600-690V 50 + 60Hz		Qty	Each
		4pol 5h	5pol 5h		
63	4	12275	5	460	
63	5	12251	5	500	
125	4	12034	5	965	
125	5	12065	5	980	

Plug TE-Plus

- Screwless terminals
- High-temperature-resistant contact carrier
- Nickel plated contacts
- Special gland, simultaneous cable gland and seal
- Protection degree IP44



210779

Amperes	Poles	600-690V 50 + 60Hz		Qty	Each
		4pol 5h	5pol 5h		
16	4	210628	10	145	
16	5	210778	10	180	
32	4	210962	10	260	
32	5	210779	10	310	

QUICK CONNECT
MULTI GRIP

Plug TE

- Screw terminal
- Box terminals
- High-temperature-resistant contact carrier
- Nickel plated contacts
- Special gland, simultaneous cable gland and seal
- Screwless enclosure connection, self locking
- Protection degree IP44 for 63A, IP67 for 125A



21461

Amperes	Poles	600-690V 50 + 60Hz		Qty	Each
		4pol 5h	5pol 5h		
63	4	21515	5	600	
63	5	21461	5	655	
125	4	21063	5	1125	
125	5	21059	5	1245	

MULTI GRIP

Surface Mounting Appliance Inlet QUICK-CONNECT TE

- Screwless terminals
- Cable entry 1x at top (open), 2x at bottom (closed)
- Base rotatable by 180°
- 4 mounting holes in enclosure base
- Suitable for through wiring
- High-temperature-resistant contact carrier
- Nickel plated contacts
- Protection degree IP44



24630

Amperes	Poles	600-690V 50 + 60Hz		Qty	Each
		4pol 5h	5pol 5h		
16	5	24628	10	305	
32	4	24629	10	380	
32	5	24630	10	385	

QUICK CONNECT

Surface Mounting Appliance Inlet TE

- Screw terminals
- Box terminals
- Cable entry 1x at top (open) and 2x at bottom (closed) for 63A
- Cable entry M50 from above for 125A
- Base rotatable by 180° for 63A
- High-temperature-resistant contact carrier
- Nickel plated contacts
- Protection degree IP44 for 63A, IP67 for 125A



24632

24543

Amperes	Poles	600-690V 50 + 60Hz		Qty	Each
		4pol 5h	5pol 5h		
63	4	24631	5	925	
63	5	24632	5	975	
125	4	24250	1	2145	
125	5	24543	1	2245	

Special Plugs and Sockets

Plugs and sockets 5h grounding position

Technical information

- IEC 60309, EN 60309, VDE 0623

Connector TE-Plus

- Screwless terminals
- High-temperature-resistant contact carrier
- Kontex contact
- Nickel plated contacts
- Special gland, simultaneous cable gland and seal
- Protection degree IP44



310508

QUICK CONNECT
MULTI GRIP

Ampere	Poles	600-690V 50 + 60Hz		Qty	Each
		4pol 5h	5pol 5h		
16	4	310441		10	170
16	5	310507		10	200
32	4	310628		10	310
32	5	310508		10	350

Connector TE

- Screw terminal
- Box terminals
- High-temperature-resistant contact carrier
- Kontex contact
- Nickel plated contacts
- Special gland, simultaneous cable gland and seal
- Screwless enclosure connection, self locking
- Protection degree IP44 for 63A, IP67 for 125A



31716

31266

MULTI GRIP

Ampere	Poles	600-690V 50 + 60Hz		Qty	Each
		4pol 5h	5pol 5h		
63	4	31719		5	625
63	5	31716		5	670
125	4	31045		5	1215
125	5	31266		5	1300

Surface Mounting Socket Outlet, Switched, Electrically Interlocked

- Stainless-steel enclosure AISI 304
- With integrated main switch and socket
- Protection degree IP55

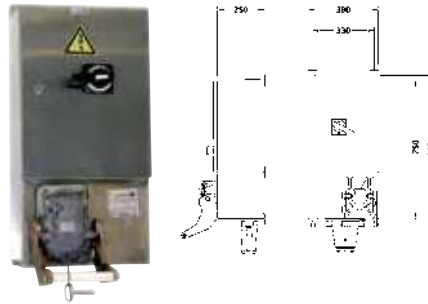

Ampere	Poles	Ref. no.	Cross section	Weight
250	4	160467		45,0 kg
400	4	160468		45,0 kg
250	5	160576		50,0 kg
400	5	160470		50,0 kg

Surface Mounting Socket Outlet, Switched, Electrically Interlocked

- Stainless-steel enclosure AISI 304
- With integrated main switch and socket
- Protection degree IP55

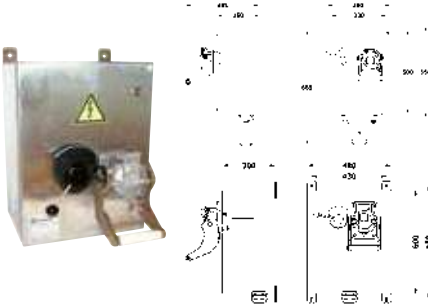

Ampere	Poles	Ref. no.	Cross section	Weight
250	4	160471		27,0 kg
400	4	160472		27,0 kg
250	5	160473		45,0 kg
400	5	160474		45,0 kg

Plug, Angled with Easy Locking System

- Metallic plugs and sockets
- External strain relief
- High-temperature-resistant contact carrier
- Silver-plated laminated contacts
- 2 internal pilot contacts for signaling and control purposes
- Plugs and sockets can be protected from dirt and dust by means of an additional protective cap
- IP66 when closed

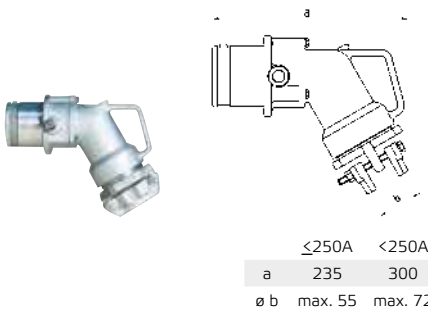

Ampere	Poles	Ref. no.	Cross section	Weight
160	4	2318	≤ 35	1,9 kg
200	4	2319	50	1,9 kg
250	4	2320	70	1,9 kg
320	4	2323	95	4,5 kg
420	4	2311	120/150	4,5 kg
160	5	2321	35	1,9 kg
200	5	2322	50	1,9 kg
250	5	2324	≤ 70	4,5 kg
320	5	2316	95	4,5 kg

Plug, Straight with Easy Locking System

- Metallic plugs and sockets
- External strain relief
- High-temperature-resistant contact carrier
- Silver-plated laminated contacts
- 2 internal pilot contacts for signaling and control purposes
- Plugs and sockets can be protected from dirt and dust by means of an additional protective cap
- IP66 when closed

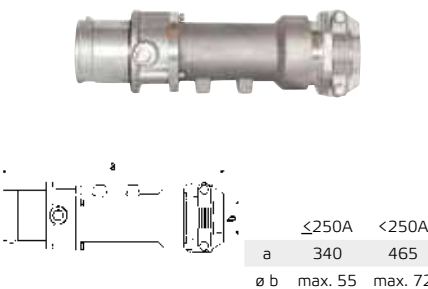

Ampere	Poles	Ref. no.	Cross section	Weight
160	4	211018	≤ 35	1,8 kg
200	4	211019	50	1,8 kg
250	4	211020	70	1,8 kg
320	4	211021	95	4,5 kg
420	4	211022	120/150	4,5 kg
160	5	211023	35	1,8 kg
200	5	211024	50	1,8 kg
250	5	211025	≤ 70	4,5 kg
320	5	211026	95	4,5 kg

Connector, Straight with Easy Locking System

- Metallic plugs and sockets
- External strain relief
- High-temperature-resistant contact carrier
- Silver-plated laminated contacts
- 2 internal pilot contacts for signaling and control purposes
- IP66 when closed

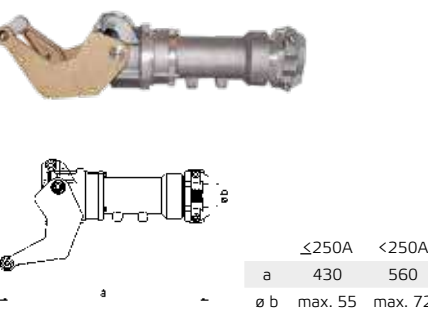

Ampere	Poles	Ref. no.	Cross section	Weight
160	4	310697	≤ 35	4,8 kg
200	4	310698	50	4,8 kg
250	4	310318	70	4,8 kg
320	4	310699	95	9,4 kg
420	4	310700	120/150	9,4 kg
160	5	310701	35	4,8 kg
200	5	310702	50	4,8 kg
250	5	310703	≤ 70	9,4 kg
320	5	310704	95	9,4 kg





1

2

3

4

5

6

7

Reefer Container

Surface Mounting Socket  Pages 211 - 212	Plugs / Inlets  Pages 211, 213	Panel Mounting Socket Outlets  Page 211	Connectors  Page 212	VARIABOX  Page 213
---	---	--	--	---







Military Facilities

Panel Mounting Socket Outlets  Pages 215 - 216	Plugs / Inlets  Pages 217 - 219	Connectors  Page 220	Domestic Plugs and Sockets  Pages 221 - 222	Accessories  Pages 222 - 223
---	--	---	---	---

Event Technology

Panel Mounting Socket Outlets  Page 225	Plugs  Pages 225 - 226	Inlets  Page 226	Connectors  Pages 226 - 227	Domestic Plugs and Sockets  Pages 227 - 228
---	---	--	---	--

Camping

Surface Mounting Socket Outlets  Page 230	Panel Mounting Socket Outlets  Page 230	Caravan Flushmounting Inlets  Page 230	Plugs / Inlets / Angled Plugs  Pages 231 - 232	Connectors  Page 232
Adapter Plugs  Page 232	Extension Leads  Page 232			

1

2

3

4

5

6

7

Plugs and sockets for special fields of application

Reefer Container

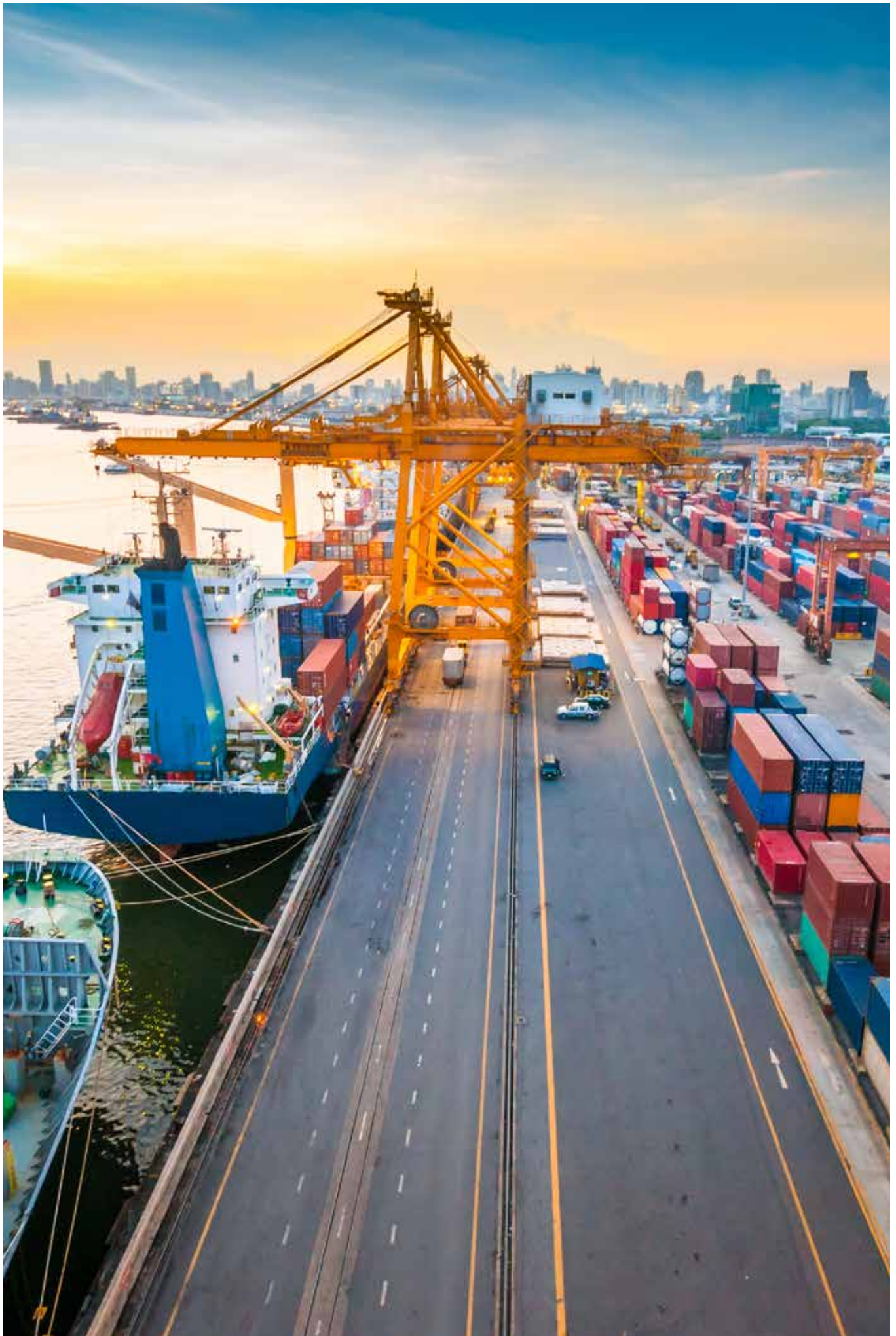

Technical information

- Container operating voltage 400 - 400V, clock face position 3h
- IEC 60309, EN60309, VDE 0623
- Protection degree IP67

Surface Mounting Socket Outlet TE

- CEE socket with screwless terminals
- Switched
- With mechanical double interlocking
- Lockable in 0-position
- High-temperature-resistant contact carrier
- Nickel plated contacts
- Protection degree IP67

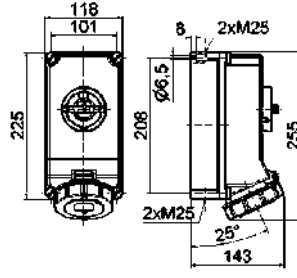

QUICK CONNECT

16050

Amperage	32	4	3P+E Poles 380V (50Hz) and 440V (60Hz) 3h	Qty 1	each 1250

Panel Mounting Socket Outlet TE

- Screw terminals
- High-temperature-resistant contact carrier
- Nickel plated contacts
- Straight
- Protection degree IP67

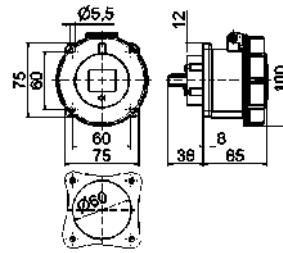

13021

Amperage	32	4	3P+E Poles 380V (50Hz) and 440V (60Hz) 3h	Qty 10	each 255

Plug TE-Plus with MULTI-GRIP

- Screwless terminals
- High-temperature-resistant contact carrier
- Nickel plated contacts
- Special gland, simultaneous cable gland and seal
- Protection degree IP67

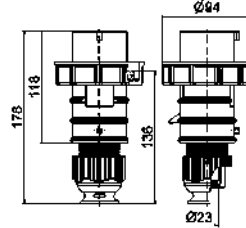

210328

Amperage	32	4	3P+E Poles 380V (50Hz) and 440V (60Hz) 3h	Qty 10	each 300

Plug with MULTI-GRIP

- One-piece enclosure
- Nickel plated contacts
- Special gland, simultaneous cable gland and seal
- Protection degree IP67

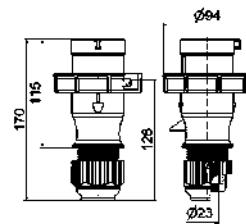

210824

Amperage	32	4	3P+E Poles 380V (50Hz) and 440V (60Hz) 3h	Qty 10	each 250
Screw terminal					
Amperage	32	4	3P+E Poles 380V (50Hz) and 440V (60Hz) 3h	Qty 10	each 250

Appliance Inlet with Flange TE

- Screw terminals
- With closure cap
- High-temperature-resistant contact carrier
- Nickel plated contacts
- Protection degree IP67

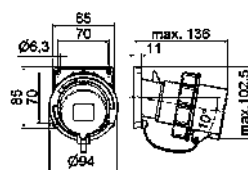

27027

Amperage	32	4	3P+E Poles 380V (50Hz) and 440V (60Hz) 3h	Qty 10	each 345

Plugs and sockets for special fields of application

Reefer Container

Technical information

- Container operating voltage 400 - 400V, clock face position 3h
- IEC 60309, EN60309, VDE 0623
- Protection degree IP67

Closure Cap

- For CEE plugs
- Protection degree IP67



832

	Order no.
16A / 3p	830
16A / 4p	835
16A / 5, 7p	831
32A / 3p, 4p	837
32A / 5p, 7p	832
63A / 3p, 4p, 5p	833
125A / 3p, 4p, 5p	834

Connector TE-Plus with MULTI-GRIP

- Screwless terminals
- High-temperature-resistant contact carrier
- Nickel plated contacts
- Special gland, simultaneous cable gland and seal
- Protection degree IP67



310426

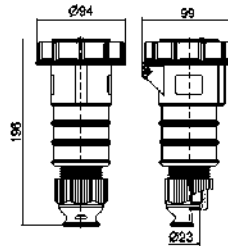

3 MB 72

Amperes	3P+E Poles	3h	Qty	9 each
32	4	310426	10	390

QUICK CONNECT
MULTI GRIP

Connector with MULTI-GRIP

- One-piece enclosure
- Nickel plated contacts
- Special gland, simultaneous cable gland and seal
- Protection degree IP67



310567

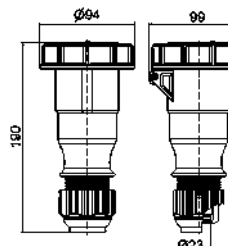

3 MB 80

Amperes	3P+E Poles	3h	Qty	9 each
32	4	310567	10	334
QUICK CONNECT				
32	4	31186-TLQ	10	314

MULTI GRIP

Surface Mounting Socket Outlet QUICK-CONNECT TE

- Screwless terminals
- High-temperature-resistant contact carrier
- Nickel plated contacts
- Protection degree IP67



11556

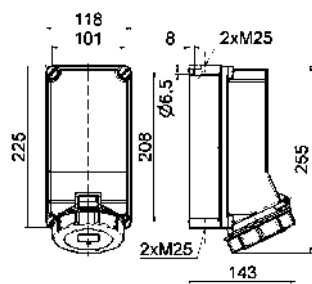

1 MB 30

Amperes	3P+E Poles	3h	Qty	9 each
32	4	11556	1	805

QUICK CONNECT

Surface Mounting Socket Outlet TE

- CEE socket with screwless terminals
- Switched
- With mechanical double interlocking
- Hinged window
- Lockable in 0-position
- High-temperature-resistant contact carrier
- Nickel plated contacts
- Protection degree IP67



17026

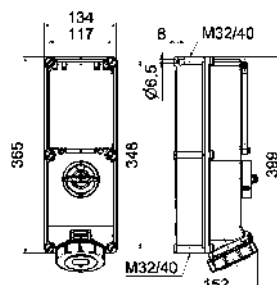

12 MB 26

Amperes	3P+E Poles	3h	Qty	9 each
32	4	17026	1	1910

QUICK CONNECT

Technical information





- Container operating voltage 400 - 400V, clock face position 3h
- IEC 60309, EN60309, VDE 0623
- Protection degree IP67

Test Plug

- Screw terminals
- For testing switch panel
- Nickel plated contacts
- Protection degree IP44



2298

					
Ampere	3P+E Poles			Qty	each
32	4	2298	1	225	

Variabox extension – switching bar:

- Perfect optical integration in the existing system
- User-friendly arrangement in the case of multiple units
- Mechanical double-interlocking
- Can be locked in the 0-position
- Nickel plated contacts
- High-temperature-resistant contact carriers
- Greater flexibility in the Variabox system landscape
- Suitable for harsh environmental conditions
- Versions in all voltages and frequencies from 16A 3-pole to 32A 5-pole
- Protection degrees IP44, IP54 and IP67

Ref. no. **896459**

VARIABOX-M

260 x 230 mm

Components:

1 CEE socket 32A, 400V, 4p, 3h, IP67 nickel plated contacts, with mechanical interlocking, lockable in 0-position

Fuse:

1 C-type MCB 32A, 3p
1 RCCB 40/0.03A, 4p

Cable entry at top and bottom:

each with 1x M12, 1x M20, 2x M40

Connection option:

2 cables up to 5 x 25 mm²



Ref. no. **896462**

VARIABOX-L

390 x 230 mm

Components:

2 CEE socket 32A, 400V, 4p, 3h, IP67 nickel plated contacts, with mechanical interlocking, lockable in 0-position

Fuse:

2 C-type MCB 32A, 3p
1 RCCB 63/0.03A, 4p

Cable entry at top and bottom:

each with 1x M12, 1x M20, 2x M40

Connection option:

2 cables up to 5 x 25 mm²



Ref. no. **896437**

VARIABOX-XL

520 x 230 mm

Components:

3 CEE socket 32A, 400V, 4p, 3h, IP67 nickel plated contacts, with mechanical interlocking, lockable in 0-position

Fuse:

3 C-type MCB 32A, 3p

Cable entry at top and bottom:

each with 1x M12, 1x M20, 2x M40

Connection option:

2 cables up to 5 x 25 mm²



Ref. no. **896463**

VARIABOX-L DUO

390 x 460 mm

Components:

4 CEE socket 32A, 400V, 4p, 3h, IP67 nickel plated contacts, with mechanical interlocking, lockable in 0-position

Fuse:

4 C-type MCB 32A, 3p
1 RCCB 63/0.03A, 4p

Cable entry at top and bottom:

each with 1x M12, 1x M20, 2x M40

Connection option:

2 cables up to 5 x 25 mm²





Technical information

- Colour: bronze-green RAL 6031-F9
 - IEC 60309, EN 60309, VDE 0623, VG 96919

Panel Mounting Socket Outlet QUICK-CONNECT

- Screwless terminals
- Straight
- Kontex contact
- High-temperature-resistant contact carrier
- Nickel plated contacts
- Flange 75 x 75 mm
- Protection degree IP67

(Form AS)

QUICK CONNECT



13066



Order no.	Supply no. 5935-12-...	VG-type-Nr. VG 96919-...	230V 50-60 Hz			400V 50-60 Hz			400V 60 Hz		301-500Hz >50V			g
			3pol	4pol	5pol	3pol	4pol	5pol	4pol	5pol	3pol	4pol	5pol	
16	3	Order no. 320-7272 AS 013	6h	9h	9h	9h	6h	6h	11h	11h	2h	2h	2h	each
16	4	Order no. 13928 AS 020	AS 020	AS 018	AS 021	AS 022							150	
16	5	Order no. 13189* AS 002	AS 002	13065* AS 001	13182* AS 003	13183* AS 004							195	
32	3	Order no. 13032 AS 042	AS 042			13932 AS 044							245	
32	4	Order no. 13933 AS 025	AS 025	13634 AS 023	13166 AS 026	13935 AS 027							265	
32	5	Order no. 13297* AS 006	AS 006	13066* AS 005	13184* AS 007	13175* AS 008							315	

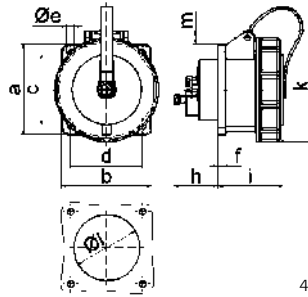

Ampere Poles	16 3	16 4	16 5	32 3	32 4	32 5
a	75,0	75,0	75,0	75,0	75,0	75,0
b	75,0	75,0	75,0	75,0	75,0	75,0
c	60,0	60,0	60,0	60,0	60,0	60,0
d	60,0	60,0	60,0	60,0	60,0	60,0
Øe	5,5	5,5	5,5	5,5	5,5	5,5
f	7,0	7,0	7,0	8,0	8,0	8,0
h	35,0	35,0	35,0	50,0	50,0	50,0
i	57,0	57,0	57,0	69,0	69,0	69,0
k	77,0	83,0	93,0	98,0	98,0	107,0
Øl	45,0	75,0	55,0	60,0	60,0	60,0
m	4,0	7,0	12,0	12,0	12,0	17,0
Cond. mm² min	1,5	1,5	1,5	2,5	2,5	2,5
Cond. mm² max	4,0	4,0	4,0	10,0	10,0	10,0

4 MB 125

Panel Mounting Socket Outlet

- Screw terminals
- Straight
- High-temperature-resistant contact carrier
- Box terminals
- Kontex contact
- Nickel plated contacts
- Flange 107 x 100 mm for 63A, 120 x 120 mm for 125A
- Protection degree IP67

(Form AS)



13067



Order no.	Supply no. 5935-12-...	VG-type-Nr. VG 96919-...	230V 50-60 Hz			400V 50-60 Hz			400V 60 Hz		301-500Hz >50V			g
			3pol	4pol	5pol	3pol	4pol	5pol	4pol	5pol	3pol	4pol	5pol	
63	3	Order no. 13186 AS 047	AS 047			13927 AS 049							500	
63	4	Order no. 13924 AS 030	AS 030	13839 AS 028	13925 AS 031	13926 AS 032							580	
63	5	Order no. 13298* AS 010	AS 010	13067* AS 009	13187* AS 011	13188* AS 012							620	
125	3	Order no. 13840 AS 052	AS 052			13923 AS 054							930	
125	4	Order no. 13919 AS 035	AS 035	13841 AS 033	13920 AS 036	13921 AS 037							1090	
125	5	Order no. 13915 AS 015	AS 015	13647 AS 014	13916 AS 016	13918 AS 017							1210	

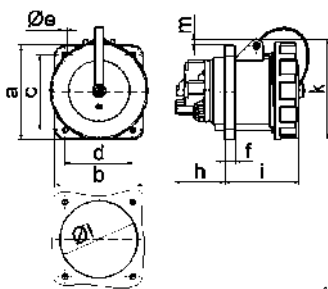

Ampere Poles	63 3	63 4	63 5	125 3	125 4	125 5
a	107,0	107,0	107,0	120,0	120,0	120,0
b	100,0	100,0	100,0	120,0	120,0	120,0
c	85,0	85,0	85,0	100,0	100,0	100,0
d	77,0	77,0	77,0	100,0	100,0	100,0
Øe	6,5	6,5	6,5	6,5	6,5	6,5
f	12,0	12,0	12,0	21,0	21,0	21,0
h	57,0	57,0	57,0	50,0	50,0	50,0
i	77,0	77,0	77,0	117,0	117,0	117,0
k	113,0	113,0	113,0	129,0	129,0	129,0
Øl	88,0	88,0	88,0	104,0	104,0	104,0
m	8,0	8,0	8,0	6,0	6,0	6,0
Cond. mm² min	6,0	6,0	6,0	25,0	25,0	25,0
Cond. mm² max	25,0	25,0	25,0	70,0	70,0	70,0

4 MB 134

Panel Mounting Socket Outlet QUICK-CONNECT

- Screwless terminals
- 20° angled
- Kontex contact
- High-temperature-resistant contact carrier
- Nickel plated contacts
- Flange 85 x 85 mm
- Protection degree IP67

(Form BS)



12087



Ampere	Poles	Order no. Supply no. 5935-12-... VG-type-Nr. VG 96919...	230V 50-60 Hz			400V 50-60 Hz		400V 60 Hz		301-500Hz >50V			g each
			3pol 6h	4pol 9h	5pol 9h	3pol 9h	4pol 6h	5pol 6h	4pol 11h	5pol 11h	3pol 2h	4pol 2h	
16	3	Order no. Supply no. 5935-12-... VG-type-Nr. VG 96919...	12085* 347-4131 BS 017							12280 BS 039		155	
16	4	Order no. Supply no. 5935-12-... VG-type-Nr. VG 96919...	120025 BS 020	12699 BS 018	120026 BS 021	120027 BS 022						175	
16	5	Order no. Supply no. 5935-12-... VG-type-Nr. VG 96919...	12242* BS 002	12086* 300-5324 BS 001	12235* BS 003	12236* BS 004						200	
32	3	Order no. Supply no. 5935-12-... VG-type-Nr. VG 96919...	12169 BS 042			120029 BS 044						250	
32	4	Order no. Supply no. 5935-12-... VG-type-Nr. VG 96919...	120030 BS 025	12700 BS 023	120031 BS 026	120032 BS 027						275	
32	5	Order no. Supply no. 5935-12-... VG-type-Nr. VG 96919...	12340* BS 006	12087* 306-7781 BS 005	12237* BS 007	12238* 311-1928 BS 008						315	

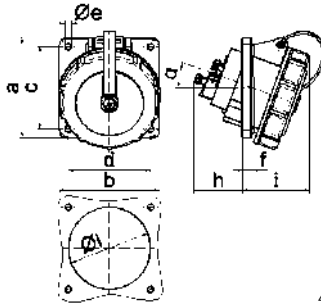

Ampere	16	16	16	32	32	32
Poles	3	4	5	3	4	5
a	85,0	85,0	85,0	85,0	85,0	85,0
b	85,0	85,0	85,0	85,0	85,0	85,0
c	70,0	70,0	70,0	70,0	70,0	70,0
d	70,0	70,0	70,0	70,0	70,0	70,0
Øe	5,5	5,5	5,5	5,5	5,5	5,5
f	8,0	8,0	8,0	8,0	8,0	8,0
h	46,0	46,0	46,0	50,0	50,0	50,0
i	57,0	57,0	60,0	67,0	67,0	67,0
Øl	57,0	65,0	70,0	78,0	78,0	78,0
α	20°	20°	20°	20°	20°	20°
Cond. mm² min	1,5	1,5	1,5	2,5	2,5	2,5
Cond. mm² max	4,0	4,0	4,0	10,0	10,0	10,0

4 MB 124

Panel Mounting Socket Outlet

- Screw terminals
- Angled
- High-temperature-resistant contact carrier
- Box terminals
- Kontex contact
- Nickel plated contacts
- Flange 114 x 114 mm
- Protection degree IP67

(Form BS)



12088



Ampere	Poles	Order no. Supply no. 5935-12-... VG-type-Nr. VG 96919...	230V 50-60 Hz			400V 50-60 Hz		400V 60 Hz		301-500Hz >50V			g each
			3pol 6h	4pol 9h	5pol 9h	3pol 9h	4pol 6h	5pol 6h	4pol 11h	5pol 11h	3pol 2h	4pol 2h	
63	3	Order no. Supply no. 5935-12-... VG-type-Nr. VG 96919...	12239 BS 047							120034 BS 049		555	
63	4	Order no. Supply no. 5935-12-... VG-type-Nr. VG 96919...	120035 BS 030	12953 BS 028	120036 BS 031	120037 BS 032						590	
63	5	Order no. Supply no. 5935-12-... VG-type-Nr. VG 96919...	12341* BS 010	12088* 347-4133 BS 009	12240* BS 011	12241* BS 012						630	
125	3	Order no. Supply no. 5935-12-... VG-type-Nr. VG 96919...	12954 BS 052			120039 BS 054						905	
125	4	Order no. Supply no. 5935-12-... VG-type-Nr. VG 96919...	120041 BS 035	12955 BS 033	120042 BS 036	120043 BS 037						965	
125	5	Order no. Supply no. 5935-12-... VG-type-Nr. VG 96919...	12342* BS 014	12191* 347-4132 BS 013	12343* BS 015	12264* 347-3942 BS 016						1045	

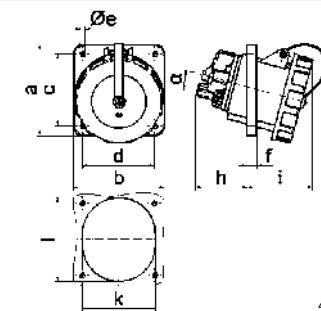

Ampere	63	63	63	125	125	125
Poles	3	4	5	3	4	5
a	114,0	114,0	114,0	114,0	114,0	114,0
b	114,0	114,0	114,0	114,0	114,0	114,0
c	90,0	90,0	90,0	90,0	90,0	90,0
d	90,0	90,0	90,0	90,0	90,0	90,0
Øe	5,5	5,5	5,5	6,5	6,5	6,5
f	12,0	12,0	12,0	12,0	12,0	12,0
h	65,0	65,0	65,0	82,0	82,0	82,0
i	82,0	82,0	82,0	90,0	90,0	90,0
k	92,0	92,0	92,0	92,0	92,0	92,0
Øl	92,0	92,0	92,0	105,0	105,0	105,0
m	15°	15°	15°	15°	15°	15°
Cond. mm² min	6,0	6,0	6,0	25,0	25,0	25,0
Cond. mm² max	25,0	25,0	25,0	70,0	70,0	70,0

4 MB 123

Technical information

- Colour: bronze-green RAL 6031-F9
 - IEC 60309, EN 60309, VDE 0623, VG 96919

Plug TE-Plus with MULTI-GRIP

- Screwless terminals
- High-temperature-resistant contact carrier
- Nickel plated contacts
- With protective cap
- Special gland, simultaneous cable gland and seal
- Protection degree IP67

(Form CP)

QUICK CONNECT
MULTI GRIP



Order no.	Supply no. 5935-12-...	VG-type-Nr. VG 96919...	230V 50-60 Hz			400V 50-60 Hz			400V 60 Hz		301-500Hz >50V			g
			3pol	4pol	5pol	3pol	4pol	5pol	4pol	5pol	3pol	4pol	5pol	
16 3			6h	9h	9h	9h	6h	6h	11h	11h	2h	2h	2h	each
16 4			CP 017	CP 020	CP 018	CP 021	CP 022							180
16 5			CP 002	CP 002	CP 001	CP 003	CP 004							265
32 3			CP 042	CP 042			CP 044							340
32 4			CP 025	CP 025	CP 023	CP 026	CP 027							380
32 5			CP 006	CP 006	CP 005	CP 007	CP 008							420



21208

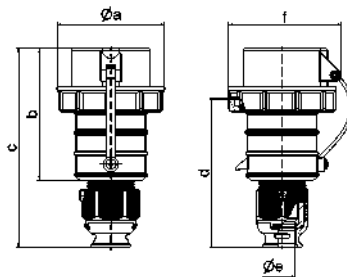

2 MB 95

Ampere Poles	16 3	16 4	16 5	32 3	32 4	32 5
Ø a	70,0	78,0	86,0	94,0	94,0	101,0
b	103,5	104,0	105,5	127,0	127,0	129,5
c	153,5	154,0	160,5	187,0	187,0	193,5
d	111,0	111,0	119,0	136,0	136,0	138,5
Ø e	18,0	18,0	21,0	23,5	23,5	27,0
f	75,5	82,5	91,0	96,5	96,5	104,5
Cond. mm² min	1,0	1,0	1,0	2,5	2,5	2,5
Cond. mm² max	2,5	2,5	2,5	6,0	6,0	6,0

Plug TE with MULTI-GRIP

- Screw terminals
- High-temperature-resistant contact carrier
- Box terminals
- Nickel plated contacts
- Special gland, simultaneous cable gland and seal
- With protective cap
- Screwless enclosure connection, self locking
- Protection degree IP67

(Form CP)

MULTI GRIP



Order no.	Supply no. 5935-12-...	VG-type-Nr. VG 96919...	230V 50-60 Hz			400V 50-60 Hz			400V 60 Hz		301-500Hz >50V			g
			3pol	4pol	5pol	3pol	4pol	5pol	4pol	5pol	3pol	4pol	5pol	
63 3			6h	9h	9h	9h	6h	6h	11h	11h	2h	2h	2h	each
63 4			CP 047	CP 000	CP 028	CP 031	CP 032							695
63 5			CP 010	CP 010	CP 009	CP 011	CP 012							815
125 3			CP 052	CP 052			CP 054							1115
125 4			CP 035	CP 035	CP 033	CP 036	CP 037							1220
125 5			CP 014	CP 014	CP 013	CP 015	CP 016							1330



21210

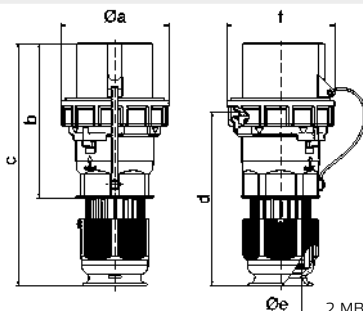

2 MB 107

Ampere Poles	63 3	63 4	63 5	125 3	125 4	125 5
Ø a	113,5	113,5	113,5	126,0	126,0	126,0
b	169,0	169,0	169,0	185,0	185,0	185,0
c	250,0	250,0	250,0	286,0	286,0	286,0
d	171,0	171,0	171,0	206,0	206,0	206,0
Ø e	36,0	36,0	36,0	50,0	50,0	50,0
f	112,5	112,5	112,5	125,0	125,0	125,0
Cond. mm² min	6,0	6,0	6,0	16,0	16,0	16,0
Cond. mm² max	25,0	25,0	25,0	50,0	50,0	50,0

Appliance Inlet with Flange

- Screw terminals
- High-temperature-resistant contact carrier
- Nickel plated contacts
- With protective cap
- Flange 85 x 85 mm
- Protection degree IP67

(Form BP)



Ampere	Poles	Order no. Supply no. 5935-12-... VG-type-Nr. VG 96919...	230V 50-60 Hz			400V 50-60 Hz		400V 60 Hz		301-500Hz >50V			g
			3pol 6h	4pol 9h	5pol 9h	3pol 9h	4pol 6h	5pol 6h	4pol 11h	5pol 11h	3pol 2h	4pol 2h	
16	3	Order no. 27046* Supply no. 5935-12-... VG-type-Nr. VG 96919...	319-7028 BP 013							27286 BP 039		205	
16	4	Order no. 27287 Supply no. 5935-12-... VG-type-Nr. VG 96919...	BP 020	27204 BP 018	27288 BP 021	27289 BP 022						230	
16	5	Order no. 27104* Supply no. 5935-12-... VG-type-Nr. VG 96919...	BP 002	2702* 300-3598 BP 001	27105* BP 003	27106* BP 004						260	
32	3	Order no. 2745 Supply no. 5935-12-... VG-type-Nr. VG 96919...	BP 042			27291 BP 044						305	
32	4	Order no. 27292 Supply no. 5935-12-... VG-type-Nr. VG 96919...	BP 025	27201 BP 023	27293 BP 026	27294 BP 027						330	
32	5	Order no. 27107* Supply no. 5935-12-... VG-type-Nr. VG 96919...	BP 006	2703* 188-9997 BP 005	27108* BP 007	27043* 312-4197 BP 008						365	



2703

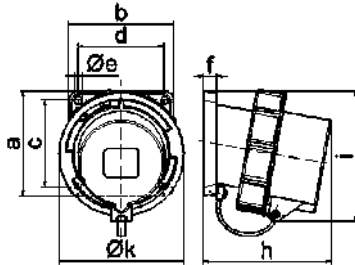

5 MB 31

Ampere	16	16	16	32	32	32
Poles	3	4	5	3	4	5
a	85,0	85,0	85,0	85,0	85,0	85,0
b	85,0	85,0	85,0	85,0	85,0	85,0
c	70,0	70,0	70,0	70,0	70,0	70,0
d	70,0	70,0	70,0	70,0	70,0	70,0
Ø e	6,3	6,3	6,3	6,3	6,3	6,3
f	11,0	11,0	11,0	11,0	11,0	11,0
h	94,0	94,0	94,0	105,0	105,0	105,0
i	94,0	97,0	101,0	103,0	103,0	107,0
k	70,5	78,5	86,5	94,0	94,0	101,5
Cond. mm² min	1,0	1,0	1,0	2,5	2,5	2,5
Cond. mm² max	2,5	2,5	2,5	6,0	6,0	6,0

Appliance Inlet with Flange

- Screw terminals
- High-temperature-resistant contact carrier
- Box terminals
- Nickel plated contacts
- With protective cap
- Flange 107 x 100 mm for 63A, 130 x 120 mm for 125A
- Protection degree IP67

(Form BP)



Ampere	Poles	Order no. Supply no. 5935-12-... VG-type-Nr. VG 96919...	230V 50-60 Hz			400V 50-60 Hz		400V 60 Hz		301-500Hz >50V			g
			3pol 6h	4pol 9h	5pol 9h	3pol 9h	4pol 6h	5pol 6h	4pol 11h	5pol 11h	3pol 2h	4pol 2h	
63	3	Order no. 27267 Supply no. 5935-12-... VG-type-Nr. VG 96919...	BP 047							27295 BP 049		630	
63	4	Order no. 27296 Supply no. 5935-12-... VG-type-Nr. VG 96919...	BP 030	27268 BP 028	27297 BP 031	27298 BP 032						695	
63	5	Order no. 27109* Supply no. 5935-12-... VG-type-Nr. VG 96919...	BP 010	2704* BP 009	27110* BP 011	27045* BP 012						750	
125	3	Order no. 27269 Supply no. 5935-12-... VG-type-Nr. VG 96919...	BP 052			27299 BP 054						1010	
125	4	Order no. 27300 Supply no. 5935-12-... VG-type-Nr. VG 96919...	BP 035	27270 BP 033	27301 BP 036	27302 BP 037						1125	
125	5	Order no. 27303 Supply no. 5935-12-... VG-type-Nr. VG 96919...	BP 015	27102 300-5323 BP 014	27304 BP 016	27305 321-5242 BP 017						1220	



2704

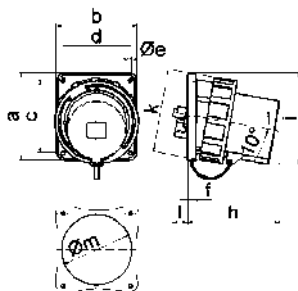

5 MB 100

Ampere	63	63	63	125	125	125
Poles	3	4	5	3	4	5
a	107,0	107,0	107,0	130,0	130,0	130,0
b	100,0	100,0	100,0	120,0	120,0	120,0
c	85,0	85,0	85,0	108,0	108,0	108,0
d	77,0	77,0	77,0	100,0	100,0	100,0
Ø e	6,5	6,5	6,5	6,5	6,5	6,5
f	12,0	12,0	12,0	13,0	13,0	13,0
h	142,0	142,0	142,0	134,0	134,0	134,0
i	124,0	124,0	124,0	138,0	138,0	138,0
k	113,5	113,5	113,5	126,0	126,0	126,0
l	-	-	-	23,0	23,0	23,0
Ø m	-	-	-	105,0	105,0	105,0
Cond. mm² min	6,0	6,0	6,0	16,0	16,0	16,0
Cond. mm² max	16,0	16,0	16,0	50,0	50,0	50,0

Technical information

- Colour: bronze-green RAL 6031-F9
 - IEC 60309, EN 60309, VDE 0623, VG 96919

Appliance Inlet with Flange

- Screw terminals
- High-temperature-resistant contact carrier
- Nickel plated contacts
- With protective cap
- Flange 85 x 85 mm
- Protection degree IP67

(Form AP)



2897



230V
50-60 Hz
3pol 4pol 5pol
6h 9h 9h

400V
50-60 Hz
3pol 4pol 5pol
9h 6h 6h

400V
60 Hz
4pol 5pol
11h 11h

301-500Hz
>50V
3pol 4pol 5pol
2h 2h 2h

g
each

Order no.	Supply no. 5935-12-...	VG-type-Nr. VG 96919...	Order no.	Supply no. 5935-12-...	VG-type-Nr. VG 96919...	Order no.	Supply no. 5935-12-...	VG-type-Nr. VG 96919...
16	3		2892			2893		
			AP 037			AP 017		
16	4		2894			2895		
			AP 001			AP 042		
16	5		2896			2897		
			AP 022			AP 005		
32	3							
32	4							
32	5							

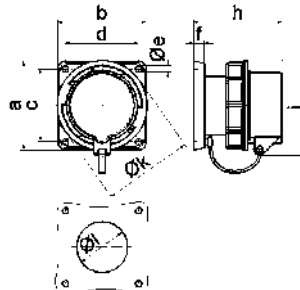

Ampere Poles	16 3	16 4	16 5	32 3	32 4	32 5
a	85,0	85,0	85,0	85,0	85,0	85,0
b	85,0	85,0	85,0	85,0	85,0	85,0
c	70,0	70,0	70,0	70,0	70,0	70,0
d	70,0	70,0	70,0	70,0	70,0	70,0
Ø e	6,3	6,3	6,3	6,3	6,3	6,3
f	11,0	11,0	11,0	11,0	11,0	11,0
h	84,0	84,0	85,0	94,0	94,0	94,0
i	82,5	86,0	91,0	96,5	96,05	104,0
Ø k	70,5	78,5	86,5	94,0	94,0	101,5
Ø l	49,0	49,0	49,0	49,0	49,0	49,0
Cond. mm² min	1,0	1,0	1,0	2,5	2,5	2,5
Cond. mm² max	2,5	2,5	2,5	6,0	6,0	6,0

5 MB 73

Appliance Inlet with flange

- Screw terminals
- High-temperature-resistant contact carrier
- Box terminals
- Nickel plated contacts
- With protective cap
- Flange 110 x 106 mm for 63A, flange 120 x 120 mm for 125A
- Protection degree IP67

(Form AP)



2853



230V
50-60 Hz
3pol 4pol 5pol
6h 9h 9h

400V
50-60 Hz
3pol 4pol 5pol
9h 6h 6h

400V
60 Hz
4pol 5pol
11h 11h

301-500Hz
>50V
3pol 4pol 5pol
2h 2h 2h

g
each

Order no.	Supply no. 5935-12-...	VG-type-Nr. VG 96919...	Order no.	Supply no. 5935-12-...	VG-type-Nr. VG 96919...	Order no.	Supply no. 5935-12-...	VG-type-Nr. VG 96919...
63	3		28042			28000		
			AP 047			AP 027		
63	4		28043			28044		
			AP 052			AP 032		
63	5		28045					
			AP 009			AP 013		
125	3							
125	4							
125	5							

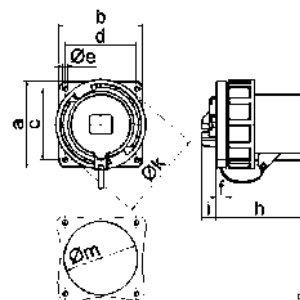

Ampere Poles	63 3	63 4	63 5	125 3	125 4	125 5
a	110,0	110,0	110,0	120,0	120,0	120,0
b	106,0	106,0	106,0	120,0	120,0	120,0
c	90,0	90,0	90,0	100,0	100,0	100,0
d	90,0	90,0	90,0	100,0	100,0	100,0
Ø e	5,5	5,5	5,5	6,5	6,5	6,5
f	13,0	13,0	13,0	13,0	13,0	13,0
h	114,0	114,0	114,0	121,0	121,0	121,0
i	19,0	19,0	19,0	20,0	20,0	20,0
Ø k	113,5	113,5	113,5	126,0	126,0	126,0
Ø m	93,0	93,0	93,0	104,0	104,0	104,0
Cond. mm² min	6,0	6,0	6,0	16,0	16,0	16,0
Cond. mm² max	16,0	16,0	16,0	50,0	50,0	50,0

5 MB 101

Connector TE-Plus with MULTI-GRIP

- Screwless terminals
- Kontex contact
- High-temperature-resistant contact carrier
- Nickel plated contacts
- Special gland, simultaneous cable gland and seal
- Protection degree IP67

(Form DS)

QUICK CONNECT
MULTI GRIP



3151



Ampere	Poles	Order no. Supply no. 5935-12-... VG-type-Nr. VG 96919...	230V 50-60 Hz		400V 50-60 Hz		400V 60 Hz		301-500Hz >50V			g each
			3pol	4pol	5pol	3pol	4pol	5pol	4pol	5pol	3pol	
16	3	Order no. 31162* Supply no. 5935-12-... VG-type-Nr. VG 96919...	312-5516									180
			DS 017								DS 039	
16	4	Order no. 310165 Supply no. 5935-12-... VG-type-Nr. VG 96919...	310165	31865	310167	310168						215
			DS 020	DS 018	DS 021	DS 022						
16	5	Order no. 31318* Supply no. 5935-12-... VG-type-Nr. VG 96919...	31318*	31150*	31319*	31320*						255
			DS 002	DS 001	DS 003	DS 004						
32	3	Order no. 31032 Supply no. 5935-12-... VG-type-Nr. VG 96919...	31032			310194						325
			DS 042			DS 044						
32	4	Order no. 310169 Supply no. 5935-12-... VG-type-Nr. VG 96919...	310169	31866	310171	310172						355
			DS 025	DS 023	DS 026	DS 027						
32	5	Order no. 31321* Supply no. 5935-12-... VG-type-Nr. VG 96919...	31321*	31151*	31322*	31323*						410
			DS 006	300-3597 DS 005	31322* DS 007	312-4196 DS 008						

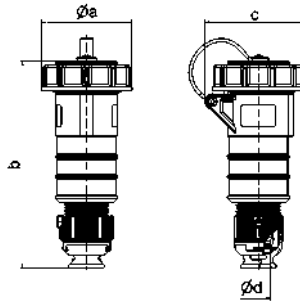

Ampere	16	16	16	32	32	32
Poles	3	4	5	3	4	5
Ø a	70,5	78,0	86,5	94,0	94,0	101,5
b	161,0	161,0	168,0	196,0	196,0	200,0
c	77,0	83,0	93,0	99,0	99,0	107,0
Ø d	18,0	18,0	21,0	23,0	23,0	27,0
Cond. mm² min	1,0	1,0	1,0	2,5	2,5	2,5
Cond. mm² max	2,5	2,5	2,5	6,0	6,0	6,0

3 MB 70

Connector with MULTI-GRIP

- Screw terminals
- High-temperature-resistant contact carrier
- Box terminals
- Kontex contact
- Nickel plated contacts
- Special gland, simultaneous cable gland and seal
- Screwless enclosure connection, self locking
- Protection degree IP67

(Form DS)

MULTI GRIP



31152



Ampere	Poles	Order no. Supply no. 5935-12-... VG-type-Nr. VG 96919...	230V 50-60 Hz		400V 50-60 Hz		400V 60 Hz		301-500Hz >50V			g each
			3pol	4pol	5pol	3pol	4pol	5pol	3pol	4pol	5pol	
63	3	Order no. 310058 Supply no. 5935-12-... VG-type-Nr. VG 96919...	310058									760
			DS 047								DS 049	
63	4	Order no. 310174 Supply no. 5935-12-... VG-type-Nr. VG 96919...	310174	31877	310175	310176						770
			DS 030	DS 028	DS 031	DS 032						
63	5	Order no. 31324* Supply no. 5935-12-... VG-type-Nr. VG 96919...	31324*	31152*	31325*	31326*						785
			DS 010	300-5326 DS 009	DS 011	DS 012						
125	3	Order no. 310059 Supply no. 5935-12-... VG-type-Nr. VG 96919...	310059			310179						1160
			DS 052			DS 054						
125	4	Order no. 310180 Supply no. 5935-12-... VG-type-Nr. VG 96919...	310180	310060	310182	310183						1255
			DS 035	DS 033	DS 036	DS 037						
125	5	Order no. 31327* Supply no. 5935-12-... VG-type-Nr. VG 96919...	31327*	31027*	31328*	31329*						1350
			DS 014	322-8597 DS 013	DS 015	DS 016						

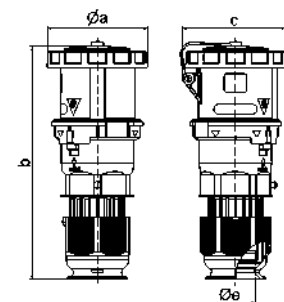

Ampere	63	63	63	125	125	125
Poles	3	4	5	3	4	5
Ø a	110,0	110,0	110,0	125,0	125,0	125,0
b	263,0	263,0	263,0	300,0	300,0	300,0
c	113,0	113,0	113,0	128,0	128,0	128,0
Ø d	36,0	36,0	36,0	50,0	50,0	50,0
Cond. mm² min	6,0	6,0	6,0	16,0	16,0	16,0
Cond. mm² max	16,0	16,0	16,0	50,0	50,0	50,0

3 MB 125

Technical information

- Colour: bronze-green RAL 6031-F9
 - VDE 0623, VG 96919

Domestic Panel Mounting Socket Outlet

- Screw terminals
- Nickel plated contacts
- 16A/230 V~
- Flange 75 x 75 mm
- Protection degree IP68

(Form AS)

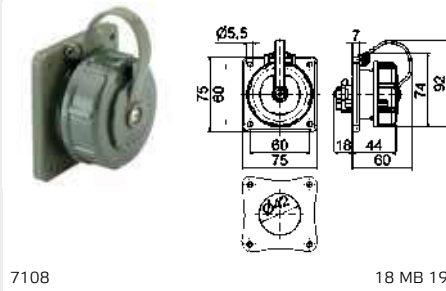

7108

18 MB 19

Ref. no. Supply no. VG-type-Nr.
 5935-12-...

german system	7108*	312-5115	AS 001
belg./ french system	7185		

Domestic Panel Mounting Socket Outlet

- Screw terminals
- Nickel plated contacts
- 16A/230 V~
- Protection degree IP68

(Form BS)

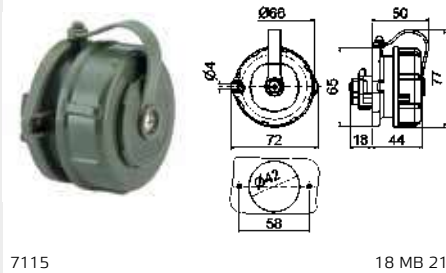

7115

18 MB 21

Ref. no. Supply no. VG-type-Nr.
 5935-12-...

german system	7115*	314-4770	BS 001
belg./ french system	7186		

Domestic Plug

- Screw terminals
- Nickel plated contacts
- 16A/230 V~
- With closure cap
- Protection degree IP68

(Form CP)

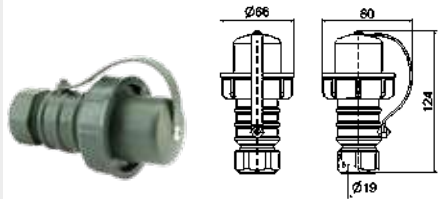

735

18 MB 18

Ref. no. Supply no. VG-type-Nr.
 5935-12-...

	735*	141-3149	CP 001
--	-------------	----------	--------

Domestic Appliance Inlet with Flange

- Screw terminals
- Nickel plated contacts
- 16A/230 V~
- With closure cap
- Flange 75 x 75 mm
- Protection degree IP68

(Form AP)

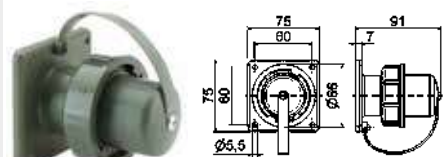

753

18 MB 16

Ref. no. Supply no. VG-type-Nr.
 5935-12-...

	753*	340-7272	AP 001
--	-------------	----------	--------

Domestic Connector

- Screw terminals
- Nickel plated contacts
- 16A/230 V~
- Protection degree IP68

(Form DS)

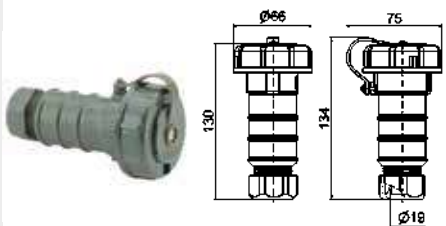

745

18 MB 26

Ref. no. Supply no. VG-type-Nr.
 5935-12-...

german system	745*	314-4771	DS 001
belg./ french system	7424		

1

2

3

4

5

6

7

Technical information

- Colour: bronze-green RAL 6031-F9
 - VDE 0623, VG 96919

Domestic Three-way Connector

- Screw terminals
- Nickel plated contacts
- 16A/230 V~
- With closure cap, hanging bracket, cable gland
- Protection degree IP68

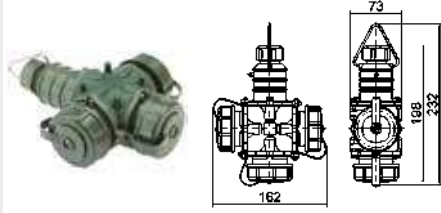

7400

18 MB 27

Ref. no. Supply no. VG-type-Nr.
 5935-12-...

german system	7400
belg./ french system	7423

Hinged Window

- Self-closing
- With touch protection
- With option for lock set

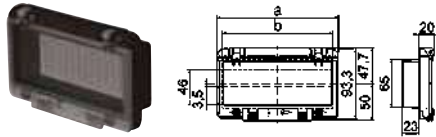

58110

30 MB 96

Module units	Dimension a	Dimension b	Ref. no.
2	55,0	40,5	580138
4	91,0	76,5	58388
6	127,0	112,5	58590
8	162,0	147,5	58110
12	234,0	220,0	58111
13	257,5	248,5	58387

Hinged Window

- Self-closing
- Without touch protection
- With option for lock set

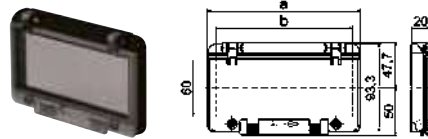

58502

30 MB 95

Module units	Dimension a	Dimension b	Ref. no.
2	55,0	37,0	58511
4	91,0	73,0	580020
6	127,0	109,0	58503
8	162,0	144,5	58502
12	234,0	217,0	58602
13	257,5	240,0	58607

Hinged Window

- Self-closing
- With touch protection
- With option for lock set
- With mounting bracket

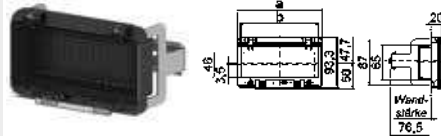

580143

30 MB 97

Module units	Dimension a	Dimension b	Ref. no.
2	55,0	40,5	580137
4	91,0	76,5	58517
6	127,0	112,5	580141
8	162,0	147,5	580143
12	234,0	220,0	580144
13	257,5	248,5	580145

Closure Cap

- for domestic plug
- Form H



8320

Ref. no. VG-Typ-Nr.
8320* H-16

Closure Cap

- für domestic connector
- Form G



8319

Ref. no. VG-type-Nr.
8319* G-16

Closure Cap with Strap

- for CEE plugs



8337

Ampere / Poles	Ref. no.	Supply no. 5935-12-...	VG-type-Nr. VG 96926...
16A / 3p	8335		
16A / 4p	8336		
16A / 5p	8337		
32A / 3p, 4p	8338		
32A / 5p	8339		
63A / 3p, 4p, 5p	8340		
125A / 3p, 4p, 5p	8341		

Closure Cap with Strap

- for CEE connector
- for CEE Panel Mounting Socket
Outlet



8330

Ampere / Poles	Ref. no.	Supply no. 5935-12-...	VG-type-Nr. VG 96926...
16A / 3p	8328		
16A / 4p	8329		
16A / 5p	8330		
32A / 3p, 4p	8331		
32A / 5p	8332		
63A / 3p, 4p, 5p	8333		
125A / 3p, 4p, 5p	8334		

Closure Cap

- for CEE plugs
- Form G



8326

Ampere / Poles	Ref. no.	Supply no. 5935-12-...	VG-type-Nr. VG 96926...
16A / 3p	8318*		G-16-3
16A / 4p	8326		G-16-4
16A / 5p	8314*		G-16-5
32A / 3p, 4p	8327		G-32-4
32A / 5p	8315*	304-8143	G-32-5
63A / 3p, 4p, 5p	8316*		G-63-5
125A / 3p, 4p, 5p	8317*		G-125-5

Closure Cap

- for CEE connector
- Form F



8309

Ampere / Poles	Ref. no.	Supply no. 5935-12-...	VG-type-Nr. VG 96926...
16A / 3p	8313*		F-16-3
16A / 4p	8324		F-16-4
16A / 5p	8309*		F-16-5
32A / 3p, 4p	8325		F-32-4
32A / 5p	8310*		F-32-5
63A / 3p, 4p, 5p	8311*		F-63-5
125A / 3p, 4p, 5p	8312*		F-125-5



Technical information

- IEC 60309, EN 60309, VDE 0623

Panel Mounting Socket Outlet QUICK-CONNECT

- Screwless terminals
- Kontex contact
- Nickel plated contacts
- Flange 75 x 75 mm
- Protection degree IP44



QUICK CONNECT

130274

2P+E Ampere	3P+E Poles	230V 50-60 Hz	400V 50-60 Hz	Quantity	Each
16	3	3pol 6h 4pol 9h 5pol 9h	3pol 9h 4pol 6h 5pol 6h	10	110
16	4	130270		10	150
16	5	130271		10	170
32	3	130272		10	190
32	4	130273		10	205
32	5	130274		10	225

Panel Mounting Socket Outlet

- Screw terminals
- Flange 107 x 100 mm
- Kontex contact
- Nickel plated contacts
- Box terminals
- Protection degree IP44



130276

2P+E Ampere	3P+E Poles	230V 50-60 Hz	400V 50-60 Hz	Quantity	Each
63	3	130275		5	415
63	5	130276		5	490

Panel Mounting Socket Outlet

- Screw terminals
- Flange 107 x 100 mm
- Kontex contact
- Nickel plated contacts
- Box terminals
- Protection degree IP67



130276

2P+E Ampere	3P+E Poles	230V 50-60 Hz	400V 50-60 Hz	Quantity	Each
63	3	130315		5	415
63	5	130196		5	570

Panel Mounting Socket QUICK-CONNECT

- Screwless terminals
- 20° angled
- Kontex contact
- Nickel plated contacts
- Flange 85 x 85 mm
- Protection degree IP44



QUICK CONNECT

120441

2P+E Ampere	3P+E Poles	230V 50-60 Hz	400V 50-60 Hz	Quantity	Each
16	3	120436		10	120
16	4	120437		10	140
16	5	120438		10	145
32	3	120439		10	200
32	4	120440		10	230
32	5	120441		10	265

Plug INNOLINQ

- Screwless terminals
- Screwless enclosure connection, self locking
- Special gland, simultaneous cable gland and seal
- Protection degree IP54
- Contact carrier is made of high temperature resistant material
- Contains no lead



QUICK CONNECT
KONTEX ULTRA
MULTI GRIP

2P+E Ampere	3P+E Poles	230V 50-60 Hz	400V 50-60 Hz	Quantity	Each
16	3	211174		10	
16	4	211175		10	
16	5	211176		10	
32	3	211171		10	
32	4	211172		10	
32	5	211173		10	

Plug TE with MULTI-GRIP

- Screw terminals
- Box terminals
- High-temperature-resistant contact carrier
- Nickel plated contacts
- Enclosure connection with thread and snap-in lock
- Special gland, simultaneous cable gland and seal
- Protection degree IP44



MULTI GRIP

210792

2P+E Ampere	3P+E Poles	230V 50-60 Hz			400V 50-60 Hz			Quantity	g
		3pol 6h	4pol 9h	5pol 9h	3pol 9h	4pol 6h	5pol 6h		
63	3	210735						5	535
63	4				211102			5	595
63	5				210792			5	650

Plug TE with MULTI-GRIP

- Screw terminals
- Box terminals
- High-temperature-resistant contact carrier
- Nickel plated contacts
- Screwless enclosure connection, snap-in lock
- Special gland, simultaneous cable gland and seal
- Protection degree IP67



MULTI GRIP

210711

2P+E Ampere	3P+E Poles	230V 50-60 Hz			400V 50-60 Hz			Quantity	g
		3pol 6h	4pol 9h	5pol 9h	3pol 9h	4pol 6h	5pol 6h		
63	3	211127						5	535
63	5				210710			5	715
125	5				210711			5	1235

Appliance Inlet QUICK-CONNECT with Flange

- Screwless terminals
- Kontex contact
- Nickel plated contacts
- Flange 75 x 75 mm
- Protection degree IP44



QUICK CONNECT

28298

2P+E Ampere	3P+E Poles	230V 50-60 Hz			400V 50-60 Hz			Quantity	g
		3pol 6h	4pol 9h	5pol 9h	3pol 9h	4pol 6h	5pol 6h		
16	3	28312						10	90
16	4				28313			10	105
16	5				28314			10	125
32	3	28315						10	145
32	4				28316			10	165
32	5				28298			10	195

Connector INNOLINQ

- Screwless terminals
- Screwless enclosure connection, self locking
- Special gland, simultaneous cable gland and seal
- Protection degree IP54
- Contact carrier is made of high temperature resistant material
- Contains no lead



QUICK CONNECT

KONTEX ULTRA

MULTI GRIP

310829

2P+E Ampere	3P+E Poles	230V 50-60 Hz			400V 50-60 Hz			Quantity	g
		3pol 6h	4pol 9h	5pol 9h	3pol 9h	4pol 6h	5pol 6h		
16	3	310827						10	120
16	4				310828			10	160
16	5				310829			10	165
32	3	310824						10	240
32	4				310825			10	260
32	5				310826			10	300

Connector with MULTI-GRIP

- Screw terminals
- Box terminals
- High-temperature-resistant contact carrier
- Kontex contact
- Nickel plated contacts
- Screwless enclosure connection, snap-in lock
- Special gland, simultaneous cable gland and seal
- Protection degree IP44



MULTI GRIP

310518

2P+E Ampere	3P+E Poles	230V 50-60 Hz			400V 50-60 Hz			Quantity	g
		3pol 6h	4pol 9h	5pol 9h	3pol 9h	4pol 6h	5pol 6h		
63	3	310488						5	590
63	4				310749			5	630
63	5				310518			5	670

Technical information

- IEC 60309, EN 60309, VDE 0623

Connector with MULTI-GRIP

- Screw terminals
- Box terminals
- High-temperature-resistant contact carrier
- Kontex contact
- Nickel plated contacts
- Enclosure connection with thread and snap-in lock
- Special gland, simultaneous cable gland and seal
- Protection degree IP67



MULTI GRIP

310466

		230V 50-60 Hz			400V 50-60 Hz			Quantity	
		3p+E Ampere	3p+E Poles	3p+E Poles	3p+E Poles	4p Poles	5p Poles	Each	Each
63	3	310771						5	650
63	5				310465			5	725
125	5				310466			5	1300

Cable Gland MULTI-GRIP with Additional Strain Relief

- In black for plugs and connectors with MULTI-GRIP cable gland



MULTI GRIP

	Ref. no.
for 16A / 3p, 4p TE + TE Plus	
16A / 3p, 4p, 5p QC + TLS	29951
for 16A / 5p TE + TE Plus	29151
for 32A / 5p TE + TE Plus	29152
for 63A / 3p, 4p, 5p TE + TE Plus	29153
for 125A / 3p, 4p, 5p TE	29154

Domestic Panel Mounting Socket Outlet

- 16A 250V ~
- Screw terminals
- Nickel plated contacts
- Without hinged lid
- Connection at rear
- Protection degree IP20



714

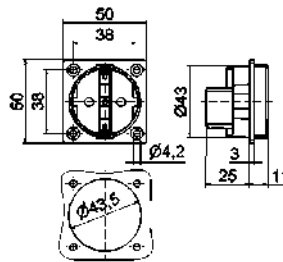

18 MB 1

Color	Ref. no.	Qty
black	714	20

Domestic Panel Mounting Socket Outlet stationary use

- 16A 250V ~
- Screwless terminals
- Nickel plated contacts
- With moulded flange seal
- Flange 50 x 50 mm
- Mounting dimension 38 x 38 mm
- Connection terminal in accordance with BGV A2
- Polyamide 6 contact carrier
- Protection degree IP54



71101

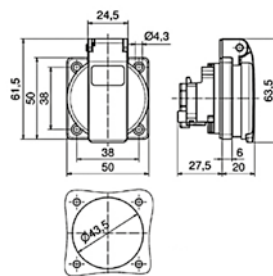

18 MB 102

Color	Ref. no.	Qty
QUICK CONNECT black	71101	20
Screw term. black	71097	20

Domestic Panel Mounting Socket Outlet mobile use

- 16A 250V ~
- Screwless terminals
- Nickel plated contacts
- With moulded flange seal
- according to DIN/VDE 620/1 for portable distribution systems
- Protection degree IP54



71104

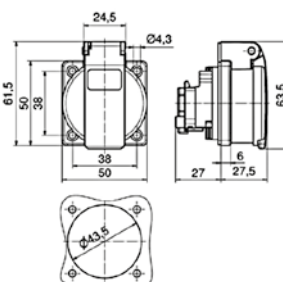

18 MB 104

Color	Ref. no.	Qty
QUICK CONNECT black	71104	20

Domestic Plug

- With MULTI-GRIP cable gland
- Spacious connection area
- Also suitable for Belgian/French system
- Protection degree IP44

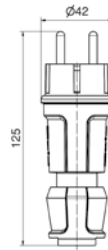

Color	Ref. no.	Qty
black	7372	20

MULTI GRIP

7372

18 MB 119

Domestic Connector

- With Multi-Grip cable gland
- Spacious connection area
- Protection degree IP54

In the case of Domestic Connectors with increased contact protect add **09** to the end of the order number.

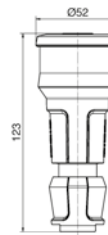

Color	Ref. no.	Qty
black	7488	20

MULTI GRIP

7488

18 MB 120



1

2

3

4

5

6

7

Technical information

- IEC 60309, EN 60309, VDE 0623
- Enclosure, insert and hinged lid made of high-grade plastic

Surface Mounting Socket Outlet

- Screw terminals
- 16A 230V 3p
- Lockable using padlock with bar diameter 5 mm
- Protection degree IP44

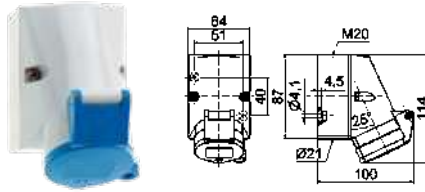

119

1 MB 53

Order no.



Qty

119

10

Panel Mounting Socket Outlet QUICK-CONNECT

- Screwless terminals
- Kontex contact
- 16A 230V 3p
- 20° angled
- Lockable by a padlock shackle diameter 5 mm
- Flange 74 x 62 mm
- Drill hole 60 x 52 mm
- Protection degree IP44

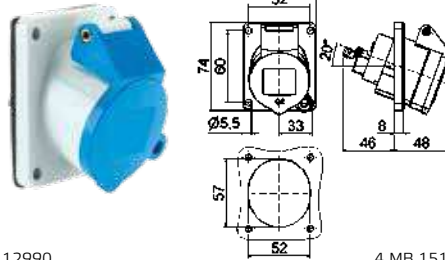

12990

4 MB 151

Ref. no.



Qty

12990

10

QUICK CONNECT

Panel Mounting Socket Outlet QUICK-CONNECT

- Screwless terminals
- Kontex contact
- 16A 230V 3p
- 20° angled
- Flange 74 x 62 mm
- Drill hole 60 x 52 mm
- Protection degree IP44

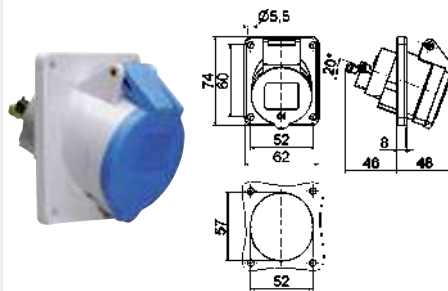

12772

4 MB 246

Ref. no.



Qty

12772

10

QUICK CONNECT

Caravan Flush Mounting Inlets

- Screw terminals
- 16A 230V 3p
- Swing-out design
- Protection degree IP44

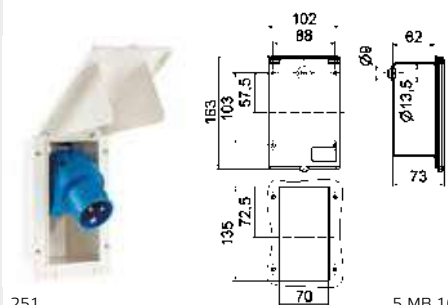

251

5 MB 16

Ref. no.



Qty

251

10

Caravan Flush Mounting Inlets

- Screw terminals
- 16A 230V 3p
- Swing-out design
- With rubber seal and frame
- For intermediate installation
- Protection degree IP44

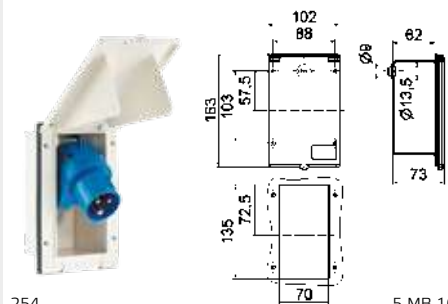

254

5 MB 16

Color

Ref. no.



Qty

white

254

10

brown

258

10

black

255

10

Technical information

- IEC 60309, EN 60309, VDE 0623
- Enclosure, insert and hinged lid made of high-grade plastic

Angled Plug

- Screw terminals
- 16A 230V 3p
- With short cable sleeve
- Protection degree IP44



231

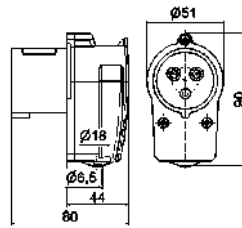

2 MB 156

Order no.



Qty

231

10

Plug

- Screw terminals
- 16A 230V 3p
- With short cable sleeve
- Lockable by a padlock shackle diameter 5 mm
- Protection degree IP44



219

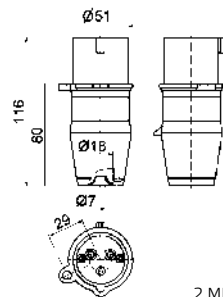

2 MB 38

Ref. no.



Qty

219

10

Plug INNOLINQ

- Screwless terminals
- Screwless enclosure connection, self locking
- Special gland, simultaneous cable gland and seal
- Protection degree IP54
- 16A 230V 3p
- Contains no lead



Dimension drawing: see page 86/1

Ref. no.



Qty

211

10

Surface Mounting Appliance Inlet

- Screw terminals
- Cable entry 1x at top (open), 1x at bottom (closed)
- 16A 230V 3p
- Protection degree IP44



240

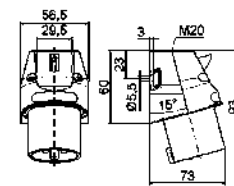

5 MB 160

Ref. no.



Qty

240

10

Surface Mounting Appliance Inlet QUICK-CONNECT

- Screwless terminals
- Cable entry 1x at top (open), 1x at bottom (closed)
- 16A 230V 3p
- Protection degree IP44



24423

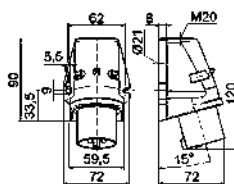

5 MB 163

Ref. no.



Qty

24423

10

Technical information

- IEC 60309, EN 60309, VDE 0623
- Enclosure, insert and hinged lid made of high-grade plastic

Surface Mounting Appliance Inlet

- Screw terminals
- Cable entry 1x at top (open), 1x at bottom (closed)
- 16A 230V 3p
- With self-closing hinged lid
- Protection degree IP44

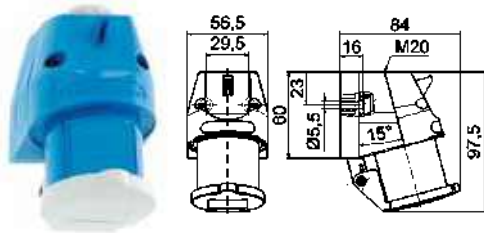

5 MB 161

Ref. no.	Qty
242	10

Surface Mounting Appliance Inlet

- Screw terminals
- 16A 230V 3p
- Cable entry 1x at top (open), 1x at bottom (closed)
- With closure cap on a plastic strap
- Protection degree IP44

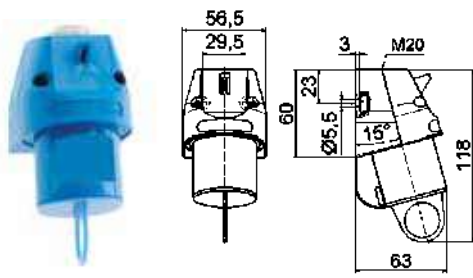

5 MB 162

Ref. no.	Qty
2400	10

Connector INNOLINQ

- Screwless terminals
- Screwless enclosure connection, self locking
- Special gland, simultaneous cable gland and seal
- Protection degree IP54
- 16A 230V 3p
- Contains no lead



Dimension drawing: see page 107/1

Ref. no.	Qty
311	10

- QUICK CONNECT
- KONTEX ULTRA
- MULTI GRIP

Adapter Plug

- Protection degree IP44



8615

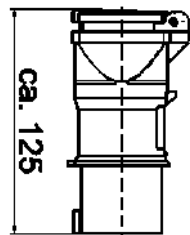

2 MB 39

Ref. no.	Qty
8615	10

CEE plug
16A/230V/3p to
Domestic sockets
16A/230V~ german
earthing system

CEE plug
16A/230V /3p to
Domestic sockets
16A/230V~ belg./
french system

Extension Lead

- Protection degree IP44

*deviating from VDE 0100 Part 708 Section 4



812

CEE plug 16A 230V
3p and CEE connector
16A 230V 3p

Domestic plug and connector

Cable	Length	Ref. no.	Qty
H07RN-F3G1,5*	10m	812	1
H07RN-F3G2,5	10m	813	1
H07RN-F3G1,5*	15m	814	1
H07RN-F3G2,5	15m	815	1
H07RN-F3G1,5*	20m	816	1
H07RN-F3G2,5	20m	817	1
H07RN-F3G2,5	1,5m	8178	1

Ref. no.	Page/Pos.	Ref. no.	Page/Pos.	Ref. no.	Page/Pos.	Ref. no.	Page/Pos.
107	41/2	318	107/1	817	232/5	1201	68/2
108	41/2	319	107/1	830	110/3	1202	68/2
109	41/4	410	197/1	831	110/3	1203	73/1
109-QC	41/1	411	197/1	832	110/3	1204	68/2
119	230/1	412	197/1	833	110/3	1205	73/1
129	73/1	413	197/1	834	110/3	1206	73/1
134	65/3	414	197/1	835	110/3	1207	68/2
136	65/3	415	197/1	837	110/3	1208	68/2
156	46/1	416	197/1	860	106/5	1299	73/3
158	46/1	417	197/1	1010	41/3	1301	65/3
159	46/1	418	197/1	1010-QC	41/1	1304	65/3
174	56/1	419	197/1	1011	41/4	1305	65/3
175	56/1	420	198/1	1012	41/2	1306	65/3
176	56/1	421	198/1	1013	41/3	1307	65/3
177	56/1	422	198/1	1015	41/5	1308	65/3
178	56/1	423	198/1	1017	41/5	1309	65/3
179	56/1	424	198/1	1018	41/5	1395	70/1
182	80/3	425	198/1	1019	41/5	1396	70/1
187	80/2	426	198/1	1020	41/4	1397	70/1
188	80/2	427	198/1	1104	37/2	1398	70/1
189	80/2	428	198/1	1106	37/2	1399	70/1
200	86/1	429	198/1	1107	37/2	1410	79/1
201	86/1	430	197/2	1108	37/2	1411	79/1
210	86/1	431	197/2	1112	39/2	1412	79/1
211	86/1 + 231/3	432	197/2	1124	37/2	1500	46/1
212	86/1	433	197/2	1125	37/2	1501	46/2
213	86/1	434	197/2	1126	37/2	1502	46/2
214	86/1	435	197/2	1127	37/2	1503	46/2
215	86/1	436	197/2	1128	37/2	1504	46/1
216	86/1	437	197/2	1129	37/2	1505	46/1
217	86/1	438	197/2	1130	37/2	1506	46/1
218	86/1	439	197/2	1132	38/2	1507	46/2
219	231/2	460	198/3	1133	38/2	1508	46/2
224	104/1	461	198/3	1134	38/2	1509	46/2
225	104/1	462	198/3	1135	38/2	1529	46/1
227	104/1	463	198/3	1136	38/2	1530	46/1
231	88/3 + 231/1	464	198/3	1137	38/2	1531	46/2
236	88/3	465	198/3	1138	38/2	1532	46/2
240	89/1 + 231/4	466	198/3	1139	38/2	1533	46/1
242	91/1 + 232/1	467	198/3	1140	38/2	1534	46/1
245	89/3	468	198/3	1141	38/2	1535	46/2
249	89/3	469	198/3	1142	38/2	1536	46/2
251	230/4	526	168/1	1143	38/2	1537	47/1
254	230/5	530	164/1	1144	38/2	1565	48/1
255	230/5	546	173/1	1145	38/2	1580	52/1
258	230/5	591	143/1	1146	38/2	1582	47/1
260	97/1	592	143/1	1147	38/2	1583	47/1
261	97/1	714	227/3	1148	38/2	1584	47/1
262	97/1	724	120/2	1149	38/2	1585	47/1
263	97/1	726	120/2	1150	38/2	1586	47/1
264	97/1	735	221/3	1151	38/2	1587	47/1
265	97/1	736	120/5	1152	38/2	1588	47/1
266	97/1	737	120/5	1153	38/2	1589	47/1
267	97/1	745	221/5	1154	38/2	1594	47/1
268	97/1	746	122/1	1155	38/2	1595	47/1
300	107/1	747	122/1	1156	39/2	1596	47/1
301	107/1	749	122/2	1157	39/2	1597	47/1
310	107/1	753	221/4	1158	39/2	1598	50/1
311	107/1	754	121/1	1159	39/2	1599	50/1
312	107/1	755	121/1	1160	39/2	1610	53/1
313	107/1	812	232/5	1161	39/2	1611	53/1
314	107/1	813	232/5	1162	39/2	1616	53/1
315	107/1	814	232/5	1163	39/2	1619	53/1
316	107/1	815	232/5	1164	39/2	1641	53/1
317	107/1	816	232/5	1200	73/1	1642	53/1



Numerical table of contents

Ref. no.	Page/Pos.	Ref. no.	Page/Pos.	Ref. no.	Page/Pos.	Ref. no.	Page/Pos.
1674	44/5	2152	86/3	2324	205/3	2634	97/2
1675	44/5	2153	86/3	2400	91/2 + 232/2	2635	97/2
1676	44/5	2154	86/3	2402	93/1	2636	97/2
1734	56/1	2155	86/3	2415	89/3	2637	98/2
1735	56/1	2180	87/3	2448	89/1	2638	98/2
1736	56/1	2181	87/3	2461	91/3	2639	98/2
1770	57/1	2182	87/3	2465	91/3	2640	98/2
1771	57/1	2183	87/3	2469	92/1	2641	98/2
1773	57/1	2184	87/3	2470	92/1	2642	98/2
1775	56/1	2185	87/3	2471	92/1	2643	98/2
1776	56/1	2186	87/3	2472	93/1	2644	98/2
1777	56/1	2187	87/3	2473	93/1	2645	98/2
1778	56/1	2188	87/3	2474	93/1	2646	98/2
1779	57/1	2189	87/3	2475	93/1	2647	98/2
1780	57/1	2190	88/1	2476	93/1	2648	98/2
1781	57/1	2191	88/1	2477	93/1	2649	97/1
1782	57/1	2192	88/1	2478	93/1	2650	98/1
1783	56/1	2193	88/1	2479	93/1	2652	104/5
1784	56/1	2194	88/1	2480	93/1	2655	97/2
1785	56/1	2195	88/1	2481	93/1	2656	97/2
1786	56/1	2196	88/1	2482	93/1	2657	97/2
1787	57/1	2197	88/1	2483	93/1	2658	97/2
1788	57/1	2198	88/1	2484	93/2	2659	98/2
1789	57/1	2199	88/1	2485	93/2	2660	98/2
1790	57/1	2213	106/1	2486	93/2	2661	98/2
1791	57/1	2214	106/1	2487	93/2	2662	97/1
1792	57/1	2215	106/1	2488	93/2	2663	97/1
1793	56/1	2216	106/1	2489	93/2	2664	97/1
1794	56/1	2217	106/1	2490	93/2	2665	98/1
1795	57/1	2218	106/1	2491	93/2	2666	98/1
1796	57/1	2219	106/1	2492	93/2	2667	98/1
1797	58/1	2220	106/1	2493	93/2	2671	97/2
1798	58/1	2221	106/1	2494	93/2	2674	105/1
1799	58/1	2222	106/1	2495	93/2	2679	97/1
1801	80/4	2223	106/1	2600	97/1	2684	97/1
1843	80/1	2224	106/1	2601	98/1	2685	97/2
1847	80/1	2225	106/1	2602	104/5	2694	98/1
1848	80/1	2226	106/1	2603	104/5	2702	218/1
1849	80/1	2227	106/1	2604	98/2	2703	218/1
1850	80/1	2229	106/3	2607	105/4	2704	218/2
1851	80/1	2230	106/3	2608	105/4	2735	100/3
1852	80/2	2231	106/3	2610	97/1	2736	100/3
1854	80/2	2232	106/3	2611	97/1	2737	100/3
1862	81/3	2233	106/3	2612	97/1	2738	100/3
1863	81/3	2234	106/2	2613	98/1	2739	100/3
1864	81/3	2235	106/2	2614	98/1	2740	100/3
1865	81/3	2236	106/2	2615	98/1	2741	103/5
1866	81/3	2251	104/3	2616	98/1	2742	100/3
1896	81/3	2252	104/3	2617	98/1	2743	100/3
2104	86/3	2266	104/3	2618	98/1	2744	100/3
2110	86/1	2267	104/3	2619	98/1	2745	218/1
2113	86/1	2271	104/2	2620	98/1	2770	99/2
2114	86/1	2286	104/2	2621	98/1	2771	103/2
2115	86/1	2287	104/2	2622	98/1	2772	103/2
2116	86/1	2288	104/2	2623	98/1	2773	99/2
2117	86/1	2298	213/1	2624	98/1	2774	103/2
2118	86/1	2300-BE	88/3	2625	97/2	2775	103/2
2119	86/1	2311	205/3	2626	97/2	2776	103/2
2120	86/1	2316	205/3	2627	97/2	2779	99/2
2121	86/1	2318	205/3	2628	97/2	2780	103/2
2122	86/1	2319	205/3	2629	97/2	2781	103/2
2123	86/1	2320	205/3	2630	97/2	2783	100/1
2149	86/3	2321	205/3	2631	97/2	2786	100/1
2150	86/3	2322	205/3	2632	97/2	2787	100/1
2151	86/3	2323	205/3	2633	97/2	2793	100/1

Ref. no.	Page/Pos.	Ref. no.	Page/Pos.	Ref. no.	Page/Pos.	Ref. no.	Page/Pos.
2833	101/3	3194	109/1	4241	198/2	4525	199/2
2834	101/3	3195	109/1	4242	198/2	4526	199/2
2835	102/2	3196	109/1	4243	198/2	4527	199/2
2836	102/2	3197	109/1	4274	198/1	4528	199/2
2837	101/3	3198	109/1	4310	197/2	4529	199/2
2838	102/2	3199	109/1	4311	197/2	4530	199/2
2841	101/3	3208	109/3	4312	197/2	4531	199/2
2842	102/2	3209	109/3	4313	197/2	4532	199/2
2853	219/2	3210	109/3	4314	197/2	4533	199/2
2857	105/3	3211	109/3	4315	197/2	4534	199/2
2858	101/3	3212	109/3	4316	197/2	4535	199/2
2860	102/3	3213	109/3	4317	197/2	4536	199/2
2861	102/3	3214	109/3	4318	197/2	4537	199/2
2864	101/3	3215	109/3	4319	197/2	4538	199/2
2869	101/3	3216	109/3	4320	197/2	4539	199/2
2870	105/3	3217	109/3	4321	197/2	4540	199/2
2876	102/3	3218	109/3	4354	197/3	4541	199/2
2880	101/3	3219	109/3	4355	197/3	4542	199/2
2881	102/2	3220	109/3	4356	197/3	4543	199/2
2882	102/3	3221	109/3	4357	197/3	4610	198/3
2892	219/1	4107	197/1	4358	197/3	4611	198/3
2893	219/1	4110	197/1	4359	197/3	4612	198/3
2894	219/1	4111	197/1	4360	197/3	4613	198/3
2895	219/1	4112	197/1	4361	197/3	4614	198/3
2896	219/1	4113	197/1	4362	197/3	4615	198/3
2897	219/1	4114	197/1	4363	197/3	4616	198/3
2898	101/2	4115	197/1	4364	197/3	4617	198/3
2899	102/1	4116	197/1	4365	197/3	4618	198/3
3104	107/3	4117	197/1	4366	197/3	4619	198/3
3108	107/3	4118	197/1	4367	197/3	4620	198/3
3109	107/3	4119	197/1	4368	197/3	4621	198/3
3110	107/1	4120	197/1	4369	197/3	5225	167/3
3111	107/1	4121	197/1	4370	197/3	5226	166/1
3112	107/3	4157	197/1	4371	197/3	5310	163/1
3113	107/1	4210	198/1	4372	197/3	5311	164/2
3114	107/1	4211	198/1	4373	197/3	5321	164/4
3115	107/1	4212	198/1	4374	197/3	5350	164/2
3116	107/1	4213	198/1	4375	197/3	5881	182/1
3117	107/1	4214	198/1	4390	197/2	5882	182/2
3118	107/1	4215	198/1	4422	199/1	5885	182/3
3119	107/1	4216	198/1	4423	199/1	5890	182/1
3120	107/1	4217	198/1	4424	199/1	5891	182/2
3121	107/1	4218	198/1	4425	199/1	5894	182/3
3122	107/1	4219	198/1	4426	199/1	5899	182/1
3123	107/1	4220	198/1	4427	199/1	6170	180/4
3124	108/3	4221	198/1	4428	199/1	6171	180/4
3149	107/3	4222	198/2	4429	199/1	6172	180/4
3150	107/3	4223	198/2	4430	199/1	6173	180/4
3151	107/3	4224	198/2	4431	199/1	7108	221/1
3152	107/3	4225	198/2	4432	199/1	7115	221/2
3153	107/3	4226	198/2	4433	199/1	7153	119/3
3154	107/3	4227	198/2	4434	199/1	7163	119/4
3180	108/3	4228	198/2	4435	199/1	7185	221/1
3181	108/3	4229	198/2	4436	199/1	7186	221/2
3182	108/3	4230	198/2	4437	199/1	7245	120/3
3183	108/3	4231	198/2	4438	199/1	7246	120/3
3184	108/3	4232	198/2	4439	199/1	7370	120/4
3185	108/3	4233	198/2	4440	199/1	7371	120/4
3186	108/3	4234	198/2	4441	199/1	7372	228/1 + 120/4
3187	108/3	4235	198/2	4442	199/1	7400	222/1
3188	108/3	4236	198/2	4443	199/1	7416	122/1
3190	109/1	4237	198/2	4481	199/1	7423	222/1
3191	109/1	4238	198/2	4522	199/2	7424	221/5
3192	109/1	4239	198/2	4523	199/2	7432	122/2
3193	109/1	4240	198/2	4524	199/2	7455	122/1

Numerical table of contents

Ref. no.	Page/Pos.	Ref. no.	Page/Pos.	Ref. no.	Page/Pos.	Ref. no.	Page/Pos.
7486	121/2	11326	38/2	11799	42/2	12039	73/1
7487	121/2	11334	202/2	11800	42/5	12052	75/1
7488	121/1 + 228/2	11341	39/2	11801	42/5	12053	75/1
7489	121/2	11342	38/2	11802	42/5	12054	75/1
7490	121/4	11343	38/2	11803	42/5	12055	73/3
7491	121/4	11345	37/2	11812	43/5	12065	203/1
7492	121/4	11350	38/2	11813	43/5	12074	68/1
7493	121/4	11368	39/2	11814	43/5	12085	216/1
8156	122/3	11390	38/2	11815	43/5	12086	216/1
8158	122/3	11429	37/2	11822	43/3	12087	216/1
8178	232/5	11432	38/2	11823	43/3	12088	216/2
8189	122/3	11433	39/2	11824	43/3	12100	73/3
8190	122/3	11436	39/3	11825	43/3	12101	73/3
8191	122/3	11437	39/3	11826	43/4	12102	73/3
8192	122/3	11438	39/3	11827	43/4	12103	73/3
8198	122/4	11439	39/3	11828	43/4	12104	73/3
8199	122/4	11440	39/3	11829	43/4	12105	73/3
8309	223/4	11441	39/3	11879	39/1	12106	73/3
8310	223/4	11442	39/3	11889	194/2	12107	73/3
8311	223/4	11443	39/3	11906	36/2	12108	73/3
8312	223/4	11444	39/3	11907	36/2	12133	73/3
8313	223/4	11445	39/3	11909	36/3	12134	68/2
8314	223/3	11446	39/3	11928	36/2	12135	68/2
8315	223/3	11447	39/3	11930	36/2	12136	68/2
8316	223/3	11448	42/3	11931	36/2	12137	68/2
8317	223/3	11449	42/3	11932	36/2	12138	68/2
8318	223/3	11451	42/3	11933	36/2	12139	75/1
8319	222/5	11452	43/1	11934	36/2	12144	200/3
8320	222/5	11453	43/1	11944	36/3	12153	68/2
8324	223/4	11455	43/1	11945	36/3	12156	77/4
8325	223/4	11461	39/1	11947	36/3	12160	77/4
8326	223/3	11476	40/2	11948	36/3	12169	216/1
8327	223/3	11477	40/2	11949	36/3	12171	73/1
8328	223/2	11478	40/2	11955	36/3	12191	216/2
8329	223/2	11479	40/2	11956	36/3	12195	68/2
8330	223/2	11480	190/1	11957	36/3	12205	77/3
8331	223/2	11481	190/1	11960	36/3	12230	68/2
8332	223/2	11482	190/1	11962	36/3	12233	73/1
8333	223/2	11483	190/1	11963	36/3	12235	216/1
8334	223/2	11485	42/1	11968	42/1	12236	216/1
8335	223/1	11487	42/1	11972	42/1	12237	216/1
8336	223/1	11492	38/3	11973	42/1	12238	216/1
8337	223/1	11493	38/3	11977	42/1	12239	216/2
8338	223/1	11496	39/1	11978	42/1	12240	216/2
8339	223/1	11538	42/1	11979	42/1	12241	216/2
8340	223/1	11542	191/2	11983	42/1	12242	216/1
8341	223/1	11555	39/1	11984	42/1	12251	203/1
8614	106/4	11556	212/4	11985	42/1	12264	216/2
8615	106/4	11566	38/3	11989	42/1	12275	203/1
8618	106/4	11579	38/3	11990	42/1	12278	73/3
11014	44/3	11580	39/1	11991	42/1	12280	216/1
11017	39/2	11630	38/3	11995	42/3	12320	73/3
11019	202/2	11634	191/2	11997	42/4	12334	73/3
11025	38/2	11635	191/3	11998	42/4	12340	216/1
11027	38/2	11640	37/2	11999	42/4	12341	216/2
11032	200/1	11714	191/3	12000	73/1	12342	216/2
11038	44/3	11748	39/2	12001	73/1	12343	216/2
11051	37/2	11785	44/1	12002	73/1	12360	74/3
11052	44/3	11786	44/1	12003	73/1	12381	68/2
11126	39/2	11787	44/1	12004	73/1	12382	68/2
11155	38/3	11790	43/1	12020	75/1	12383	68/2
11156	39/1	11795	37/2	12025	75/1	12389	73/1
11208	37/2	11796	42/2	12032	72/2	12390	190/3
11221	37/2	11797	42/2	12034	203/1	12391	190/3
11320	38/2	11798	42/2	12035	73/1	12392	190/3

Ref. no.	Page/Pos.	Ref. no.	Page/Pos.	Ref. no.	Page/Pos.	Ref. no.	Page/Pos.
12393	190/3	12759	67/1	12825	72/1	12990	230/2
12394	191/5	12760	67/1	12826	72/1	13032	215/1
12395	191/5	12761	67/1	12831	72/1	13051	65/3
12396	191/5	12762	67/1	12832	72/1	13064	215/1
12397	191/5	12763	67/1	12833	72/1	13065	215/1
12398	76/3	12764	67/1	12834	72/1	13066	215/1
12401	76/3	12765	67/1	12835	72/1	13067	215/2
12405	76/4	12766	67/1	12836	72/1	13070	200/2
12406	76/4	12767	67/1	12837	72/1	13075	202/4
12407	76/4	12768	67/1	12838	72/1	13077	65/3
12408	76/4	12769	67/1	12839	72/1	13083	77/1
12409	77/4	12770	67/1	12840	72/1	13098	215/1
12410	77/4	12771	67/2	12841	72/1	13100	70/1
12511	74/3	12772	67/2 + 230/3	12842	72/1	13101	70/1
12555	74/2	12773	67/2	12843	72/1	13102	70/1
12563	68/1	12774	67/2	12844	72/1	13103	70/1
12565	68/1	12775	67/2	12846	72/1	13104	70/1
12566	68/1	12776	67/2	12847	72/1	13140	65/3
12567	68/1	12777	67/2	12848	72/1	13144	76/1
12568	68/1	12778	67/2	12849	72/1	13156	77/1
12569	72/2	12779	67/2	12850	72/1	13157	77/1
12570	72/2	12780	67/2	12851	72/1	13159	77/1
12571	72/2	12781	67/2	12852	72/1	13166	215/1
12572	72/2	12782	67/2	12853	72/1	13168	65/3
12573	72/2	12783	67/2	12854	72/1	13175	215/1
12574	72/2	12784	67/2	12855	72/1	13182	215/1
12596	74/2	12785	67/2	12856	72/1	13183	215/1
12616	74/3	12786	67/2	12857	72/1	13184	215/1
12646	74/2	12787	67/2	12861	67/1	13186	215/2
12648	74/2	12788	67/2	12862	67/1	13187	215/2
12649	74/2	12789	67/2	12863	67/1	13188	215/2
12650	74/2	12790	67/2	12864	67/1	13189	215/1
12651	74/2	12791	67/2	12865	67/1	13254	65/3
12652	74/2	12792	67/2	12866	67/1	13297	215/1
12653	74/2	12793	67/2	12867	67/1	13298	215/2
12689	195/1	12794	67/2	12868	67/1	13320	65/3
12699	216/1	12795	67/2	12869	67/1	13321	65/3
12700	216/1	12796	67/2	12870	67/1	13326	190/2
12730	67/2	12797	67/2	12871	67/1	13327	190/2
12731	66/1	12798	67/2	12872	67/1	13328	190/2
12732	66/1	12799	67/2	12873	67/1	13329	190/2
12733	66/1	12800	67/2	12874	67/2	13330	191/4
12734	66/1	12801	67/2	12876	76/3	13331	191/4
12735	66/1	12802	67/2	12877	76/3	13332	191/4
12736	66/1	12803	67/2	12878	76/3	13333	191/4
12739	66/1	12804	67/2	12880	76/3	13334	76/1
12740	66/1	12805	67/3	12882	76/3	13336	76/1
12741	66/1	12806	67/3	12883	76/3	13341	76/2
12742	66/1	12808	71/2	12884	76/3	13342	76/2
12743	66/3	12809	71/2	12917	71/3	13343	76/2
12744	66/3	12810	71/2	12919	77/3	13344	76/2
12745	66/3	12811	71/2	12920	77/3	13382	77/2
12746	66/3	12812	71/2	12921	77/3	13383	77/2
12747	66/3	12813	71/3	12922	77/3	13384	77/2
12748	67/1	12814	71/3	12924	77/3	13385	77/2
12749	67/1	12815	71/3	12925	77/3	13434	71/1
12750	67/1	12816	71/3	12926	77/3	13435	71/1
12751	67/1	12817	71/3	12927	77/3	13436	71/1
12752	67/1	12818	71/3	12928	77/3	13442	71/1
12753	67/1	12819	71/3	12929	71/3	13445	70/3
12754	67/1	12820	71/3	12930	71/3	13447	70/3
12755	67/1	12821	71/3	12931	71/3	13448	70/3
12756	67/1	12822	71/3	12953	216/2	13449	70/3
12757	67/1	12823	71/3	12954	216/2	13451	70/3
12758	67/1	12824	71/3	12955	216/2	13452	70/3

Numerical table of contents

Ref. no.	Page/Pos.	Ref. no.	Page/Pos.	Ref. no.	Page/Pos.	Ref. no.	Page/Pos.
13476	76/1	13713	64/1	13841	215/2	15102	46/1
13515	71/1	13714	64/1	13849	202/4	15103	46/1
13592	65/3	13715	64/1	13850	64/2	15104	46/1
13613	194/4	13716	64/1	13851	64/2	15105	46/1
13633	215/1	13717	64/1	13895	65/2	15106	46/2
13634	215/1	13718	64/1	13896	65/2	15107	46/2
13646	64/3	13719	69/1	13915	215/2	15108	46/2
13647	215/2	13720	69/1	13916	215/2	15109	46/2
13656	64/3	13721	69/1	13918	215/2	15110	46/2
13657	64/3	13724	69/1	13919	215/2	15111	48/1
13658	64/3	13725	69/1	13920	215/2	15112	48/1
13659	64/3	13726	69/1	13921	215/2	15113	48/1
13660	64/3	13727	69/1	13923	215/2	15114	48/1
13661	64/3	13730	69/1	13924	215/2	15115	48/1
13662	64/3	13731	69/1	13925	215/2	15116	48/1
13663	64/3	13732	69/1	13926	215/2	15121	48/1
13664	64/3	13733	69/2	13927	215/2	15122	48/1
13665	64/3	13734	69/2	13928	215/1	15123	48/1
13666	64/3	13735	69/2	13929	215/1	15124	48/1
13667	65/1	13736	69/2	13930	215/1	15125	47/1
13668	65/1	13737	69/2	13932	215/1	15126	47/1
13669	65/1	13738	69/2	13933	215/1	15127	48/1
13670	65/1	13739	69/2	13935	215/1	15128	48/1
13671	65/1	13740	69/2	15000	50/1	15129	49/1
13672	65/1	13741	69/2	15001	50/1	15130	49/1
13673	65/1	13742	69/2	15006	52/2	15131	49/1
13674	65/1	13743	69/2	15007	52/2	15132	49/1
13675	65/1	13744	69/2	15008	52/2	15133	50/1
13676	65/1	13745	69/2	15009	52/2	15134	50/1
13677	65/1	13746	69/2	15013	50/1	15138	49/1
13678	65/1	13747	69/2	15017	49/1	15139	49/1
13679	65/1	13748	69/2	15019	46/1	15140	49/1
13680	65/1	13749	69/2	15024	46/2	15141	49/1
13681	65/1	13750	69/2	15027	48/1	15142	50/1
13682	65/1	13751	69/2	15028	48/1	15143	50/1
13683	65/1	13752	69/2	15029	47/1	15144	50/1
13684	65/1	13753	69/2	15030	47/1	15145	50/1
13685	64/1	13754	69/2	15035	49/1	15146	49/1
13686	64/1	13755	69/2	15036	49/1	15147	49/1
13687	64/1	13756	69/2	15038	51/1	15148	49/1
13688	64/1	13757	69/2	15042	52/2	15149	50/1
13689	64/1	13758	69/2	15043	52/2	15150	50/1
13690	64/1	13759	69/2	15044	47/1	15151	50/1
13691	64/1	13760	69/2	15045	47/1	15152	51/1
13692	64/1	13761	69/2	15047	52/1	15153	51/1
13693	64/1	13762	69/2	15052	49/1	15154	51/1
13694	64/1	13763	69/2	15058	49/1	15155	51/1
13695	64/1	13764	69/2	15059	46/1	15156	51/1
13696	64/1	13765	69/2	15072	52/1	15157	52/1
13697	64/1	13771	76/1	15075	52/1	15158	52/1
13698	64/1	13773	76/1	15076	47/1	15159	52/1
13699	64/1	13774	76/1	15077	47/1	15160	52/1
13700	64/1	13775	76/1	15078	48/1	15161	51/1
13701	64/1	13776	76/1	15079	48/1	15162	51/1
13702	64/1	13777	76/1	15080	50/1	15163	51/1
13703	64/1	13810	77/1	15081	49/1	15164	51/1
13704	64/1	13812	77/1	15082	49/1	15165	52/1
13705	64/1	13813	77/1	15083	50/1	15166	52/1
13706	64/1	13814	77/1	15095	46/1	15167	52/1
13707	64/1	13815	77/1	15096	46/1	15168	52/1
13708	64/1	13816	77/1	15097	46/2	15169	52/1
13709	64/1	13822	194/3	15098	46/2	15170	52/1
13710	64/1	13835	64/2	15099	46/2	15171	52/1
13711	64/1	13839	215/2	15100	46/2	15172	49/1
13712	64/1	13840	215/2	15101	46/1	15174	50/1

Ref. no.	Page/Pos.	Ref. no.	Page/Pos.	Ref. no.	Page/Pos.	Ref. no.	Page/Pos.
15175	50/1	16907	60/1	17167	58/1	17315	57/1
15176	48/1	16915	61/1	17168	58/1	17316	58/1
15177	48/1	16916	61/1	17169	58/1	17317	58/1
15239	46/1	16930	55/1	17170	58/1	17319	59/1
15240	46/2	16933	53/3	17175	59/1	17320	59/1
15352	48/1	16934	54/3	17176	59/1	17322	58/1
15382	46/1	16956	53/3	17177	59/1	17323	58/1
15383	46/2	17000	58/1	17178	59/1	17324	58/1
15384	46/1	17001	59/1	17179	59/1	17325	58/1
15385	46/2	17002	59/1	17180	59/1	17328	59/1
15386	46/1	17003	59/1	17181	59/1	17329	59/1
15387	46/2	17004	59/1	17182	59/1	17330	59/1
15388	48/1	17007	58/1	17186	58/1	17331	59/1
16008	53/1	17008	58/1	17187	58/1	17334	57/1
16038	53/2	17009	58/1	17188	58/1	17335	56/1
16039	53/2	17010	58/1	17189	58/1	17336	57/1
16040	54/2	17011	59/1	17192	59/1	17337	56/1
16041	54/2	17012	59/1	17193	59/1	17338	56/1
16042	53/2	17013	59/1	17194	59/1	17339	56/1
16043	53/2	17014	59/1	17195	59/1	17340	57/1
16050	211/1	17019	58/1	17213	59/1	17341	57/1
16058	53/2	17020	58/1	17216	59/1	17342	57/1
16059	54/2	17021	59/1	17233	56/1	17343	58/1
16060	53/2	17022	59/1	17234	56/1	17344	58/1
16064	53/2	17026	212/5	17238	57/1	17345	59/1
16065	54/2	17027	56/1	17275	56/1	17346	59/1
16066	53/2	17028	56/1	17276	56/1	17387	59/1
16070	44/4	17029	57/1	17277	56/1	17521	58/1
16071	44/4	17030	57/1	17278	57/1	17522	58/1
16072	44/4	17031	57/1	17279	57/1	17523	58/1
16093	53/3	17032	56/1	17280	56/1	17524	58/1
16097	53/2	17033	56/1	17281	56/1	17525	58/1
16104	54/2	17034	57/1	17282	56/1	17526	58/1
16123	53/2	17035	57/1	17283	56/1	17527	58/1
16124	54/2	17036	57/1	17284	56/1	17528	58/1
16125	54/3	17037	56/1	17285	56/1	17529	58/1
16138	54/1	17038	57/1	17286	56/1	17530	58/1
16374	192/3	17039	58/1	17287	56/1	17531	58/1
16378	192/4	17040	58/1	17288	56/1	17532	58/1
16380	192/5	17041	59/1	17289	57/1	17533	58/1
16441	192/3	17042	59/1	17290	57/1	17534	58/1
16445	192/4	17044	58/1	17291	57/1	17535	58/1
16447	192/5	17045	58/1	17292	57/1	17536	58/1
16449	201/3	17046	59/1	17293	57/1	17537	58/1
16450	201/4	17047	59/1	17294	57/1	17538	59/1
16602	54/3	17055	56/1	17295	57/1	17539	59/1
16603	53/3	17056	56/1	17296	57/1	17540	59/1
16604	54/3	17057	56/1	17297	57/1	17541	59/1
16605	53/3	17058	56/1	17298	56/1	17542	59/1
16606	54/3	17059	56/1	17299	56/1	17543	59/1
16620	55/1	17060	56/1	17300	56/1	17544	59/1
16621	55/1	17061	57/1	17301	56/1	17545	59/1
16622	55/1	17062	57/1	17302	56/1	17546	59/1
16721	53/3	17063	57/1	17303	56/1	17547	59/1
16827	53/3	17064	57/1	17304	56/1	17548	59/1
16828	54/3	17065	57/1	17305	56/1	17549	59/1
16831	55/1	17066	57/1	17306	56/1	17550	59/1
16871	44/2	17087	58/1	17307	57/1	17551	59/1
16872	44/2	17107	58/1	17308	57/1	17552	59/1
16873	44/2	17134	58/1	17309	57/1	17553	59/1
16875	54/2	17162	57/1	17310	57/1	17554	59/1
16886	61/4	17163	58/1	17311	57/1	17555	58/1
16890	61/5	17164	58/1	17312	57/1	17556	58/1
16901	60/4	17165	58/1	17313	57/1	17557	58/1
16906	60/1	17166	58/1	17314	57/1	17558	58/1

Numerical table of contents

Ref. no.	Page/Pos.	Ref. no.	Page/Pos.	Ref. no.	Page/Pos.	Ref. no.	Page/Pos.
17559	59/1	21239	87/1	21689	86/2	24199	94/3
17560	59/1	21240	87/1	21690	86/2	24200	94/3
17561	59/1	21241	87/1	21691	86/2	24201	94/3
17562	59/1	21250	87/1	21692	86/2	24202	94/3
17566	62/1	21251	87/1	21693	86/2	24208	104/4
17569	62/1	21282	87/1	21706	201/1	24209	104/4
17573	62/1	21300	86/3	21711	192/1	24210	104/4
17576	62/1	21301	86/1	21712	192/1	24211	104/4
17579	62/1	21330	87/3	21754	87/1	24216	93/2
17583	63/1	21349	87/1	21785	195/3	24220	94/3
17586	63/1	21350	87/1	21837	86/2	24221	94/3
17590	63/1	21351	87/1	21838	86/2	24222	94/3
17593	63/1	21352	87/1	21839	86/2	24232	94/2
17596	63/1	21375	87/3	21840	86/2	24241	195/5
17604	63/1	21380	217/1	21841	86/2	24250	203/5
17608	62/1	21402	87/1	21842	86/2	24258	94/1
17612	62/1	21403	87/1	21843	86/2	24279	94/3
17615	62/1	21404	87/1	21844	86/2	24320	94/2
17618	62/1	21405	87/1	21847	86/2	24335	92/1
17622	62/1	21406	87/1	21848	86/2	24336	90/2
17626	62/1	21407	87/1	21849	86/2	24337	90/2
17629	62/1	21408	87/1	21850	86/2	24338	90/2
17632	62/1	21409	87/1	21851	88/1	24339	90/2
17635	62/1	21410	87/1	21868	200/4	24340	94/2
17638	62/1	21411	87/1	21869	200/5	24341	94/2
17642	63/1	21412	87/1	21872	86/2	24342	94/2
17646	63/1	21413	87/1	21873	86/2	24362	90/1
17649	63/1	21414	87/1	21876	200/5	24408	90/1
17652	63/1	21419	86/3	21879	86/2	24409	90/1
17656	63/1	21423	217/1	21882	200/4	24410	90/1
17660	63/1	21424	217/1	21885	86/2	24411	90/1
17663	63/1	21425	217/1	21907	195/2	24412	90/1
17666	63/1	21426	217/1	21966	195/3	24413	90/1
17669	63/1	21427	217/1	22052	104/1	24414	92/2
17672	63/1	21428	217/2	22053	104/1	24415	92/2
17847	56/1	21429	217/2	22054	104/1	24416	93/3
18010	79/2	21430	217/2	22055	104/1	24418	93/3
18048	81/2	21431	217/2	24012	92/1	24419	94/1
18049	81/2	21432	217/2	24013	93/2	24423	231/5
21024	86/3	21433	217/2	24017	92/1	24543	203/5
21025	86/3	21453	87/1	24018	92/1	24551	90/1
21033	217/2	21461	203/3	24019	92/1	24594	195/5
21052	86/1	21484	87/1	24020	93/1	24625	195/4
21059	203/3	21486	87/1	24021	93/1	24626	195/4
21060	87/3	21487	87/1	24022	93/1	24627	195/4
21062	86/1	21515	203/3	24023	93/2	24628	203/4
21063	203/3	21526	86/3	24024	93/2	24629	203/4
21150	86/1	21531	86/3	24025	93/2	24630	203/4
21154	87/3	21533	87/1	24035	94/2	24631	203/5
21155	88/1	21545	87/1	24062	94/2	24632	203/5
21156	88/1	21555	88/1	24078	93/2	24659	89/2
21163	87/3	21557	190/4	24079	93/1	24660	89/2
21167	86/3	21558	87/1	24089	93/2	24661	89/2
21168	86/1	21564	87/1	24101	93/1	24663	89/2
21174	86/1	21607	88/1	24114	93/1	24664	89/2
21189	86/1	21623	86/2	24134	90/2	24667	89/2
21198	86/1	21624	86/3	24140	94/2	24671	89/2
21208	217/1	21645	87/3	24145	94/2	24673	89/2
21209	217/1	21658	86/1	24154	93/1	24674	89/2
21210	217/2	21663	86/3	24193	190/5	24675	89/2
21220	217/1	21667	192/1	24194	190/5	24677	89/2
21221	217/1	21669	192/1	24195	190/5	24678	89/2
21232-TLQ	211/4	21686	86/2	24196	190/5	24682	89/2
21237	87/1	21687	86/2	24197	94/3	24684	89/2
21238	87/1	21688	86/2	24198	94/3	24690	89/2

Ref. no.	Page/Pos.	Ref. no.	Page/Pos.	Ref. no.	Page/Pos.	Ref. no.	Page/Pos.
24691	89/2	27109	218/2	27302	218/2	31150	220/1
24694	89/2	27110	218/2	27303	218/2	31151	220/1
24695	89/2	27117	193/3	27304	218/2	31152	220/2
24699	89/2	27118	193/3	27305	218/2	31162	220/1
24701	89/2	27119	193/3	28000	219/2	31183	108/3
24702	89/2	27120	193/3	28001	101/1	31186-TLQ	212/3
24703	89/2	27121	103/1	28002	101/1	31207	108/2
24705	89/2	27122	103/1	28003	101/1	31240	108/2
24706	89/2	27124	103/1	28004	101/1	31241	108/2
24710	89/2	27201	218/1	28005	101/1	31242	108/2
24712	89/2	27204	218/1	28006	101/1	31243	108/2
24713	89/2	27207	103/1	28008	101/1	31244	108/2
24714	89/2	27209	99/1	28009	101/1	31245	108/2
24716	89/2	27210	103/1	28010	101/1	31246	108/2
24717	89/2	27211	99/1	28011	101/1	31247	108/2
26001	193/1	27212	103/1	28012	101/1	31251	108/3
26002	193/1	27215	99/1	28013	101/1	31257	107/3
26003	193/2	27216	103/1	28014	101/1	31266	204/2
26004	193/2	27217	103/1	28015	101/1	31270	107/1
26005	193/2	27218	99/1	28017	101/1	31298	108/2
26006	193/2	27219	103/1	28042	219/2	31299	108/2
26008	104/5	27220	103/1	28043	219/2	31301	108/2
26009	105/4	27221	99/1	28044	219/2	31302	108/2
26010	105/4	27222	103/1	28045	219/2	31303	108/2
26012	193/1	27223	103/1	28100	101/2	31304	108/2
26013	193/1	27224	103/1	28101	102/1	31305	108/2
26015	97/2	27227	100/1	28102	101/2	31306	108/2
26020	105/1	27228	100/1	28103	102/1	31307	108/2
26023	97/1	27229	100/1	28104	101/2	31308	108/2
26026	97/1	27230	103/3	28105	102/1	31309	108/2
26028	97/1	27233	100/1	28106	101/2	31310	108/2
26029	97/1	27234	100/1	28107	102/1	31311	108/2
26030	97/1	27235	100/1	28108	101/2	31312	108/2
26033	98/1	27236	100/1	28109	102/1	31313	108/2
26036	97/1	27237	100/1	28111	101/1	31314	108/2
26050	95/1	27238	100/1	28112	101/1	31318	220/1
26051	95/1	27239	100/1	28181	105/2	31319	220/1
26052	95/2	27240	100/1	28182	105/5	31320	220/1
26053	95/2	27241	103/3	28183	105/2	31321	220/1
26054	96/1	27244	100/1	28184	105/5	31322	220/1
26055	96/1	27245	100/1	28298	226/3	31323	220/1
26056	96/2	27246	100/1	28312	226/3	31324	220/2
26057	96/2	27247	99/1	28313	226/3	31325	220/2
26065	97/1	27248	103/1	28314	226/3	31326	220/2
27006	100/2	27249	103/1	28315	226/3	31327	220/2
27007	100/2	27267	218/2	28316	226/3	31328	220/2
27008	100/2	27268	218/2	29129	110/4	31329	220/2
27009	100/2	27269	218/2	29132	110/2	31409	108/2
27010	100/2	27270	218/2	29133	110/2	31417	109/1
27011	100/2	27278	103/3	29148	110/2	31457	108/2
27012	103/4	27286	218/1	29149	110/2	31500	107/3
27015	100/2	27287	218/1	29150	110/2	31501	108/2
27016	100/2	27288	218/1	29151	227/2	31504	108/3
27017	100/2	27289	218/1	29152	227/2	31505	108/3
27024	103/5	27291	218/1	29153	227/2	31512	192/2
27027	211/5	27292	218/1	29154	227/2	31513	192/2
27043	218/1	27293	218/1	29951	227/2	31514	192/2
27045	218/2	27294	218/1	31027	220/2	31515	192/2
27046	218/1	27295	218/2	31032	220/1	31533	107/2
27102	218/2	27296	218/2	31045	204/2	31534	107/2
27104	218/1	27297	218/2	31049	107/1	31536	107/2
27105	218/1	27298	218/2	31082	108/3	31602	107/1
27106	218/1	27299	218/2	31085	107/3	31603	107/1
27107	218/1	27300	218/2	31086	107/3	31604	107/1
27108	218/1	27301	218/2	31094	107/1	31605	108/3

Numerical table of contents

Ref. no.	Page/Pos.	Ref. no.	Page/Pos.	Ref. no.	Page/Pos.	Ref. no.	Page/Pos.
31606	107/3	53681	165/1	71012	79/1	89134	136/2
31611	109/1	53909	165/1	71013	79/1	89142	135/3
31627	196/2	54566	172/3	71028	119/3	89146	134/1
31641	196/2	54567	173/1	71071	120/1	89148	136/3
31642	107/3	54568	172/2	71097	227/4	89987	136/3
31659	107/2	54569	172/3	71101	227/4	110000	42/4
31661	107/2	54580	173/4	71104	227/5	110014	43/2
31662	107/2	54655	172/1	71118	119/1	110015	43/2
31664	107/2	54657	172/1	71119	119/1	110016	43/2
31665	107/2	54740	173/2	71120	119/1	110017	43/2
31666	107/2	54741	173/3	71121	119/2	110018	42/3
31669	107/2	54801	173/4	71122	119/2	110019	42/4
31670	107/2	54880	172/2	71123	119/2	110020	43/1
31671	107/2	54929	173/2	71142	119/5	110073	36/3
31672	107/2	57074	175/3	72010	78/2	110075	39/1
31677	201/2	57076	174/1	72011	78/2	110094	38/3
31681	107/2	57078	174/2	81000	122/4	110098	42/4
31716	204/2	57092	174/1	81001	122/4	110140	194/2
31719	204/2	57116	174/3	81002	122/4	110322	36/3
31723	107/3	57117	174/2	81003	122/4	110328	202/2
31724	108/3	57119	174/3	85000	156/1	110353	194/1
31752	191/1	57143	162/3	85002	156/2	110383	37/2
31779	196/1	57148	162/1	85005	157/2	110387	43/1
31858	107/3	57250	175/2	85006	156/1	110388	43/1
31865	220/1	57255	162/3	85007	156/2	110394	194/1
31866	220/1	57360	176/4	85008	156/3	110413	39/2
31877	220/2	57623	162/2	85009	157/1	110415	37/2
31884	107/2	57829	175/2	85016	157/1	110416	39/2
31891	107/1	57996	162/2	85034	157/2	110435	38/3
31892	107/1	58001	182/2	85036	156/3	110436	38/3
31906	107/1	58004	182/3	89000	130/3	110445	37/2
31907	107/1	58009	182/1	89002	130/2	110446	39/2
31919	107/1	58010	182/2	89003	130/1	110451	36/3
31955	107/2	58013	182/3	89004	130/2	110452	39/3
31956	107/2	58018	182/1	89006	130/1	110468	39/3
31957	107/2	58019	182/2	89010	131/3	110481	202/1
31959	107/2	58022	182/3	89013	132/1	110486	37/3
31962	107/2	58027	182/1	89015	132/1	110487	37/3
31964	107/2	58028	182/2	89016	131/1	110488	40/1
31965	107/2	58031	182/3	89017	132/2	110489	40/1
31966	107/2	58036	182/5	89022	132/3	110541	37/1
31967	107/2	58037-BE	182/4	89028	132/2	110542	37/1
31968	107/2	58110	220/2	89037	131/2	110543	37/1
31970	107/2	58111	220/2	89038	132/3	110544	37/1
31971	107/2	58370	181/4	89040	131/2	110545	37/1
31972	107/2	58387	220/2	89044	131/3	110546	37/1
31973	107/2	58388	220/2	89048	132/4	110547	37/1
31974	107/2	58400	110/1	89070	133/3	110548	37/1
31975	107/2	58401	110/1	89075	133/2	110549	37/1
31976	107/2	58402	110/1	89076	133/3	110550	37/1
31979	107/2	58502	222/3	89084	133/1	110551	37/1
31981	107/2	58503	222/3	89085	133/1	110552	37/1
31983	107/2	58511	222/3	89086	133/2	110553	37/1
31984	107/2	58517	222/4	89094	134/2	110554	37/1
43003	197/3	58590	220/2	89095	134/3	110555	37/1
45044	199/2	58602	222/3	89099	134/2	110556	37/1
52480	168/3	58607	222/3	89101	134/3	110557	37/1
52638	168/2	61101	180/5	89107	134/1	110558	37/1
53141	163/2	61128	180/5	89119	135/2	110559	38/1
53213	164/3	61133	180/1	89120	135/2	110560	38/1
53247	164/3	61134	180/2	89122	135/1	110561	38/1
53290	163/3	61402	180/3	89123	135/3	110562	38/1
53420	163/3	71001	119/4	89127	135/1	110563	38/1
53525	163/2	71010	78/1	89128	136/1	110564	38/1
53679	165/2	71011	78/1	89129	136/1	110565	38/1

Ref. no.	Page/Pos.	Ref. no.	Page/Pos.	Ref. no.	Page/Pos.	Ref. no.	Page/Pos.
110566	38/1	120043	216/2	130275	225/2	210403	217/1
110567	38/1	120150	194/5	130276	225/2	210404	217/1
110568	38/1	120157	194/5	130277	194/3	210405	217/1
110569	38/1	120158	77/3	130278	194/3	210406	217/1
110570	38/1	120159	77/3	130279	194/4	210408	217/1
110571	38/1	120161	77/3	130280	202/3	210409	217/1
110572	38/1	120162	77/3	130281	202/3	210410	217/1
110573	38/1	120256	194/5	130282	202/3	210411	217/1
110574	38/1	120274	72/3	130283	202/3	210413	217/2
110575	38/1	120275	202/5	130315	225/3	210414	217/2
110576	38/1	120277	202/5	132001	64/1	210415	217/2
110577	194/1	120280	195/1	132002	64/1	210417	217/2
110578	194/1	120282	194/5	160048	54/1	210419	217/2
110579	194/1	120306	68/3	160049	54/1	210421	217/2
110580	202/1	120307	73/2	160052	54/1	210422	217/2
110581	202/1	120320	72/3	160053	54/1	210423	217/2
110582	202/1	120321	68/3	160055	54/1	210550	190/4
110583	202/2	120322	73/2	160056	54/1	210575	87/2
110620	36/1	120336	202/5	160057	54/1	210576	87/2
110622	36/1	120342	72/3	160058	54/1	210577	87/2
110624	36/1	120368	202/5	160087	192/5	210578	87/2
110625	36/1	120387	73/2	160177	54/2	210579	87/2
110626	36/1	120431	68/3	160178	54/2	210580	87/2
110627	36/1	120436	225/4	160179	54/2	210581	87/2
110631	36/1	120437	225/4	160180	60/2	210582	87/2
110633	36/1	120438	225/4	160181	60/3	210583	87/2
110635	36/1	120439	225/4	160182	61/2	210584	87/2
110636	36/1	120440	225/4	160184	61/3	210585	87/2
110637	36/1	120441	225/4	160290	54/3	210586	87/2
110638	36/1	120442	194/5	160438	192/4	210587	87/2
110642	36/1	120583	74/1	160467	205/1	210588	87/2
110644	36/1	120584	74/1	160468	205/1	210589	87/2
110646	36/1	120585	74/1	160470	205/1	210590	87/2
110647	36/1	120586	74/1	160471	205/2	210591	87/2
110649	36/1	120587	74/1	160472	205/2	210592	87/2
110650	36/1	120588	74/1	160473	205/2	210593	87/2
110653	36/1	120589	74/1	160474	205/2	210594	87/2
110656	36/1	120590	74/1	160576	205/1	210595	87/2
110658	36/1	120591	74/1	210030	86/3	210596	87/2
110660	36/1	120592	74/1	210067	190/4	210597	87/2
110661	36/1	121317	74/2	210077	217/1	210598	87/2
110662	36/1	122001	66/3	210078	217/1	210599	87/2
110666	36/1	130010	78/1	210120	86/1	210600	87/2
110668	36/1	130011	78/1	210122	86/1	210601	87/2
110670	36/1	130012	78/1	210133	86/1	210602	87/2
110671	36/1	130040	194/3	210169	86/2	210603	87/2
110672	36/1	130055	202/4	210170	86/2	210604	87/2
110673	36/1	130077	194/3	210171	86/2	210605	87/2
110710	78/2	130111	76/1	210176	86/2	210606	87/2
110711	78/2	130114	66/1	210178	86/2	210607	87/2
110712	78/2	130119	70/2	210179	86/2	210608	87/2
120025	216/1	130130	66/1	210184	86/2	210609	87/2
120026	216/1	130131	70/2	210185	86/2	210610	87/2
120027	216/1	130153	66/1	210186	86/2	210628	203/2
120029	216/1	130154	70/2	210193	86/2	210636	190/4
120030	216/1	130156	211/2	210197	86/2	210668	195/2
120031	216/1	130158	69/3	210222	87/1	210710	226/2
120032	216/1	130196	225/3	210234	87/1	210711	226/2
120034	216/2	130232	202/4	210238	195/2	210735	226/1
120035	216/2	130269	225/1	210256	217/2	210761	86/3
120036	216/2	130270	225/1	210263	217/2	210762	87/3
120037	216/2	130271	225/1	210264	217/2	210763	86/3
120039	216/2	130272	225/1	210265	217/2	210764	87/3
120041	216/2	130273	225/1	210358	195/2	210765	86/3
120042	216/2	130274	225/1	210402	195/2	210766	87/3

Numerical table of contents

Ref. no.	Page/Pos.	Ref. no.	Page/Pos.	Ref. no.	Page/Pos.	Ref. no.	Page/Pos.
210778	203/2	310358	108/1	560965	153/1	580658	183/2
210779	203/2	310362	108/1	560967	151/1	580659	183/2
210792	226/1	310363	108/1	561090	177/1	580721	183/4
210824	211/4	310364	108/1	561449	152/2	580727	183/3
210950	88/2	310381	191/1	561844	153/2	580860	181/1
210951	88/2	310415	108/2	561872	154/1	581273	183/1
210962	203/2	310417	108/2	562306	152/2	581276	141/1
210964	88/1	310426	212/2	562366	178/2	581323	181/4
211018	205/4	310441	204/1	562372	177/1	581324	181/4
211019	205/4	310465	227/1	562373	151/2	581325	181/4
211020	205/4	310466	227/1	562374	152/1	581338	141/1
211021	205/4	310488	226/5	562376	154/2	581433	185/1
211022	205/4	310490	107/3	562377	152/1	748609	121/3
211023	205/4	310491	108/3	562378	154/1	748709	121/3
211024	205/4	310492	107/3	562379	153/2	748809	121/3
211025	205/4	310493	108/3	562380	154/2	748909	121/3
211026	205/4	310494	107/3	562389	177/2	749009	121/5
211102	226/1	310495	108/3	562390	177/2	749109	121/5
211127	226/2	310507	204/1	562391	178/1	749209	121/5
211133	88/1	310508	204/1	562392	178/1	749309	121/5
211171	225/5	310518	226/5	562393	178/2	890011	132/4
211172	225/5	310519	196/1	570451	176/2	890083	136/2
211173	225/5	310554	108/2	570531	175/4	890400	131/1
211174	225/5	310564	196/1	571121	175/1	890919	137/1
211175	225/5	310567	212/3	571276	175/4	890920	137/1
211176	225/5	310628	204/1	571370	176/4	890921	137/2
282001	101/1	310634	109/2	572185	171/3	890922	137/2
282002	101/1	310635	109/2	572238	176/2	890923	137/3
310044	196/1	310697	205/5	572301	176/1	890924	137/3
310058	220/2	310698	205/5	572551	171/2	890925	138/1
310059	220/2	310699	205/5	572567	171/1	890926	138/1
310060	220/2	310700	205/5	573143	176/1	890927	138/2
310068	196/1	310701	205/5	573151	176/3	890928	138/2
310123	191/1	310702	205/5	573395	175/1	890929	138/3
310163	220/1	310703	205/5	573671	171/2	890930	138/3
310165	220/1	310704	205/5	574339	171/1	890931	138/4
310167	220/1	310749	226/5	574420	171/3	890932	138/4
310168	220/1	310771	227/1	576086	162/1	890933	139/1
310169	220/1	310824	226/4	576277	175/3	890934	139/1
310171	220/1	310825	226/4	576282	176/3	890935	139/2
310172	220/1	310826	226/4	580020	222/3	890936	139/2
310174	220/2	310827	226/4	580137	222/4	890937	139/3
310175	220/2	310828	226/4	580138	220/2	890938	139/3
310176	220/2	310829	226/4	580141	222/4	890939	139/4
310177	220/2	521828	169/3	580143	222/4	893419	140/1
310179	220/2	522143	168/2	580144	222/4	895347	140/2
310180	220/2	522144	166/3	580145	222/4	896285	142/1
310182	220/2	522167	169/2	580508	179/3	896294	139/4
310183	220/2	522589	168/4	580511	181/2	896329	140/3
310194	220/1	522590	166/1	580521	181/2	896346	140/1
310311	191/1	523291	168/4	580529	181/2	896347	140/2
310318	205/5	524443	169/2	580589	179/2	896368	142/2
310331	108/1	524446	170/1	580640	183/3	896373	142/1
310333	108/1	524449	167/2	580641	183/4	896374	142/2
310334	108/1	530003	164/1	580642	110/5 + 183/3	896376	142/3
310338	108/1	530090	165/2	580643	183/4	896377	142/3
310339	108/1	530179	163/1	580647	183/1	896400	140/3
310340	108/1	530321	164/4	580648	183/1	896437	213/3
310344	108/1	530425	165/3	580649	183/1	896459	213/2
310345	108/1	530426	165/3	580650	183/1	896462	213/2
310346	108/1	540055	173/3	580651	183/1	896463	213/3
310350	108/1	560030	179/1	580652	183/1	2148509	211/3
310351	108/1	560384	151/2	580653	183/1	5200568	167/2
310352	108/1	560508	151/1	580656	183/2	5200917	167/4
310356	108/1	560509	153/1	580657	183/2	5201003	170/3

Ref. no.	Page/Pos.	Ref. no.	Page/Pos.
5201004	167/3	50003203	141/4
5201015	166/3	50003205	141/3
5201047	166/2	50003206	141/2
5201555	168/3	50003208	141/2
5201558	166/2	50003209	141/2
5201926	167/1	50003210	141/2
5202236	167/1	50003211	141/2
5202237	167/4	50003218	141/3
5202238	168/1	51010578	55/2
5202239	169/1		
5202240	169/1		
5202241	169/3		
5202242	170/1		
5202243	170/2		
5202244	170/3		
5202245	170/4		
5202469	170/2		
5202470	170/4		
5202999	161/1		
5203000	161/2		
5203001	161/3		
5401274	148/3		
5401302	148/1		
5401343	147/2		
5401453	148/2		
5401455	147/1		
5401567	147/1		
5401662	147/3		
5401668	147/2		
5401882	146/1		
5401884	146/1		
5401886	146/2		
5401892	146/2		
5401894	146/3		
5402044	147/3		
5402046	148/1		
5402047	148/3		
5402049	150/1		
5402050	150/1		
5402051	150/2		
5402052	150/2		
5402053	150/3		
5402054	150/3		
5402059	148/4		
5402060	148/4		
5402159	149/1		
5402160	149/1		
5402161	149/2		
5402162	149/2		
5402163	149/3		
5402164	149/3		
5402165	149/4		
5402166	149/4		
5402794	146/3		
5402795	148/2		
7111809	119/1		
7111909	119/1		
7112009	119/1		
7112109	119/2		
7112209	119/2		
7112309	119/2		
20001402	141/4		
33010594	81/3		
50002819	141/2		
50003186	141/2		

1. Scope of applicability, master agreement, contract conclusion

- 1.1 The following Terms and Conditions shall apply exclusively for our deliveries and services to entrepreneurs (§ 14 of the German Civil Code (BGB)). Any purchasing terms and conditions to the contrary are not legally enforceable, even if we do not explicitly reject them. By placing an order and/or accepting the delivery thereof, the buyer acknowledges acceptance of our terms and conditions.
- 1.2 An order becomes binding for us once we have issued a written confirmation or upon having begun to fulfil the order. All agreements concluded between us and the ordering party for the purpose of performance of this contract are recorded in writing in this contract.
- 1.3 The following terms and conditions apply to existing business relationships as well as to future business dealings which do not specifically make reference to them.

2. Offers, cost estimates, prices and the reserved right to make price changes

- 2.1 Our offers, as well as the prices and delivery options stated in our catalogues, printed materials, letters, etc. are subject to change without notice; cost estimates are non-binding.
- 2.2 All orders shall only be accepted on the basis of prices valid at the time of order placement. Our prices are understood to be in euro (Incoterms® 2010), ex works, exclusive of the respective VAT, and excluding freight, customs duty, additional import fees, packaging and insurance, which may possibly have to be charged separately.
- 2.3 With respect to all orders – including call-off orders and multiple delivery contracts – for which the delivery, as provided for in the contract or at the request of the ordering party, takes place later than four months after order placement, we are authorised within the scope of the order and as compensation to pass along to the ordering party any material and labour price increases occurring between contract conclusion and actual delivery.
- 2.4 For new orders (including follow-up orders), we are not obligated to any previous prices.

3. Commercial and intellectual property rights

- 3.1 The sales documents made available by the selling party – such as drafts, drawings, advertising and video material – shall still remain property of the selling party even if proportional costs have been remunerated for this purpose by the buyer.
- 3.2 The selling party unrestrictedly reserves all of his commercial rights, intellectual property rights and exploitation rights to cost estimates, drawings and other documents (hereinafter referred to as: Documents). The documents may only be made accessible to third parties upon the prior consent of the selling party, and must be – in the event that the order is not issued to the selling party – promptly returned to the selling party at his request. Clauses 1 and 2 apply correspondingly to documents of the buyer; these may however be made accessible to those third parties whom the selling party has permissibly commissioned to carry out deliveries.

4. Shipping, costs, transfer of risk

- 4.1 The shipping shall take place on the account and risk of the buyer. We bear no liability – also not in the case of carriage paid delivery – for damage or losses incurred during transport. If nothing else has been agreed, we shall decide on the type of packaging and means of shipping.
- 4.2 If shipment is delayed due to circumstances for which we

bear no responsibility, then the transfer of risk shall take place on the day that the buyer has been notified of the readiness for shipment.

5. Packaging

- 5.1 Insofar as nothing to the contrary has been agreed, we shall select the packaging, mode of shipment and the shipping route.
- 5.2 If the goods have been billed according to weight, then the usage of packaging and wrapping material shall be calculated at a price according to the gross weight.
- 5.3 Special, not commercially customary packaging material shall be charged extra.
- 5.4 Upon the written request of the buyer, the goods shall be insured at his own expense against risks to be determined by him.

6. Delivery deadlines and liability provisions, acceptance obligation in case of blanket orders and call-off orders, return deliveries

- 6.1 The delivery period shall begin as soon as all delivery details have been clarified, both parties agree on all of the terms and conditions of the transaction and the ordering party has effected payment of an agreed instalment, if applicable. The delivery deadline has been complied with if, until it expires, either the delivery item has departed the plant or the ordering party has been notified as to its readiness for shipment.
- 6.2 The adherence to our delivery obligation within the agreed delivery deadline further presupposes the prompt, correct and complete fulfilment of all obligations on the part of the buyer. The right to objection of the non-fulfilment of contract remains reserved.
- 6.3 If our delivery does not take place in adherence to the deadline and also not within an extended deadline – which must consist of at least 20 workdays – set by the ordering party, due to reasons for which we bear responsibility, then the ordering party is entitled to void the ordered delivery.
- 6.4 In the event of subsequent order amendment, we are no longer bound to the originally assured and confirmed delivery deadline.
- 6.5 Subsequent order amendments, quantity changes and cancellations can only be accepted if they do not entail any costs for us; otherwise, we shall be compelled to charge the buyer for the costs.
- 6.6 In case of contracts with continuous delivery, the arrangement according to class and type must be communicated to us in due time. If call-offs of partial quantities are not communicated in due time, we shall be authorised to – after first having set an indisputable extended deadline – designate and deliver partial quantities ourselves, or alternatively to withdraw from the nonfulfilled portion of the contract as per the further prerequisites of Paragraph 6.8 and to require indemnification as restitution for the ensuing loss that we suffer. The right to enforcement of further damage claims as might possibly arise remains undiminished.

- 6.7 The regulation in Paragraph 11 shall apply for compensation claims due to delayed fulfilment or non-fulfilment in lieu of performance.
- 6.8 If force majeure or circumstances for which we cannot be held accountable (e.g. operational disruptions, strikes) hinder us in the punctual fulfilment of the order, we are then entitled in order to fulfil assumed obligations to reasonably postpone delivery or, if the hindrances consequently

make contract performance impossible, to withdraw from the contract in whole or in part. The same holds true if we have not received delivery of material at all, or with delay, from our suppliers which we have ordered from them and which is required for fulfilment of the order, due to reasons for which we cannot be held accountable. The prerequisite for a withdrawal is that we promptly inform the ordering party about the unavailability and, as the case may be, immediately refund any consideration provided by the ordering party. Claims for indemnification of any kind are hereby excluded.

- 6.9 Partial deliveries are permissible.

7. Quality guidelines for production and delivery

- 7.1 Tolerances:
As a rule, we apply quality assurance methods to our production, which as a minimum comply with ISO 9001 requirements. Production is carried out based on the respectively applicable testing and assessment guidelines, as well as the tolerances for weight, dimensional and quantity variations specified therein.

7.2 Production processes

The selling party thereby reserves the right to change the production processes insofar as the buying party has not required any restrictions or information obligation with regard to them.

8. Retention of title

- 8.1 We shall retain title to the delivery item (goods subject to retention of title) until all of our accounts receivable due from the ordering party from the business relationship, including any accounts receivable which might arise in the future – comprising those contracts concluded at the same time or at a later date, have been settled. In case of running accounts, the retained title and all rights apply as collateral for our entire current account balance claims, together with interest and costs. In the event of seizures or other intervention by third parties, the ordering party must immediately inform us.
- 8.2 The ordering party is authorised to process and resell the delivery item in the ordinary course of business. This authorisation shall end if the ordering party is in payment default, or additionally in case of the cessation of payments by the ordering party, or if the opening of insolvency proceedings has been filed against the assets of the ordering party (default / enforcement event). The ordering party is obliged to resell the item delivered under reservation of title only under the condition of title retention and to ensure that the accounts receivable derived from the resale are transferred to us as per 8.5. Also regarded as resale is if the goods subject to retention of title are used to fulfil works contracts and works-supply contracts. The ordering party is not entitled to any other dispositions regarding the goods subject to retention of title, particularly the pledging of goods or transfer of security. An assignment of accounts receivable from the transfer of our goods subject to retention of title is not permitted, unless it is a matter of an assignment within the course of true factoring, which must be shown to us and for which the value of the factoring proceeds exceeds the amount of our secured receivables. Our accounts receivable are due immediately once the factoring proceeds have been credited.
- 8.3 Pursuant to Art. 950 of the BGB, the ordering party does not acquire ownership of a new item through the treating and processing of the goods subject to retention of title. The processing or transformation is undertaken for us without obligating us. The treated and processed goods are regarded as goods subject to retention of title.
- 8.4 In the case of processing, combining and mixing of the goods subject to retention of title with other goods,

our claim entitlement to co-ownership of the new good amounts to the proportional invoice value of the goods subject to retention of title in comparison with the invoice value the other goods used. If our property rights are rendered null and void through combining, mixing or processing, consequently the ordering party shall immediately transfer to us the property rights and expectancy rights pertaining to the new form of the item to which he is entitled proportionate to the invoice value of the goods subject to retention of title and, in the case of processing, proportionate to the invoice value of the goods subject to retention of title vis-à-vis the invoice value of the other goods used, and maintain custody of it for us free of charge. Our co-ownership rights are regarded as goods subject to retention of title.

- 8.5 The accounts receivable of the ordering party derived from the reselling of the goods subject to retention of title are to be assigned to us now by way of security. These serve as collateral in the same scope as the goods subject to retention of title. If the goods subject to retention of title are resold by the ordering party together with other goods, then the accounts receivable derived from the resale shall be assigned to us proportionate to the invoice value of the goods subject to retention of title vis-à-vis the invoice value of the other goods. In the event of a resale of the goods for which we hold co-ownership shares as per 8.4, a share of the accounts receivable shall be assigned to us corresponding to our coownership share. Other accounts receivable which take the place of the goods subject to retention of title or which otherwise arise with respect to the goods subject to retention of title - such as insurance claims and claims from a breach of duty or an unlawful act - shall also be assigned. The ordering party is irrevocably entitled to collect the accounts receivable assigned to us in his own name. We may revoke the direct debit mandate in the case of a default / enforcement event.
- 8.6 The ordering party authorises us to inform the customer of the assignment and to collect the accounts receivable as soon as the default / enforcement event occurs. We can require a review of the status of the assigned accounts receivable by our agents based on the bookkeeping of the ordering party. The ordering party must provide us with a list of the residual goods subject to retention of title and all information necessary for asserting the assigned accounts receivable, including a list of his accounts receivable from the resale of the goods subject to retention of title with the name and address of the customer.
- 8.7 If the value of the existing collateral exceeds the total secured receivables by more than 10%, then at the request of the ordering party we are obligated to release collateral to that extent, at our discretion and in observance of the interests of the ordering party. The collateral value is regarded as the invoice value for simple and subsequent retention of title at which the ordering party procures the goods from us, and for extended retention of title the invoice value at which the ordering party resells our goods, each with a valuation discount of one third of the subscription price or the nominal value of the assigned accounts receivable.
- 8.8 In the event of cheques or other means of payment, payment is only then regarded as having been made after secured posting of the sum by the ordering party. We shall only accept cheques on account of performance. Payments that have been made against the transfer of a cheque or another means of payment are only then considered as having been remitted once a reversal to us is precluded. Notwithstanding our extended collateral rights, the collateral ceded to us up to this point in time continues to exist.
- 8.9 Based on the retention of title, we can require the possession of the delivery item if we have withdrawn from the contract. We are authorised to withdraw without taking

into account any of the further prerequisites of Art. 323 of the BGB, in particular without having to set a deadline, from that point in time at which the ordering party has defaulted on payment in whole or in part. The same holds true if the ordering party has ceased payment or if the opening of insolvency proceedings has been filed against the assets of the ordering party. All costs arising from the repossession of the delivery item shall be borne by the ordering party. We are authorised to freely dispose of the reclaimed delivery item.

- 9. **Notification of defects, claims for defects, liability provision**
 - 9.1 Notwithstanding the continued duty of inspection, notification, and rejection due in a mutual commercial transaction, the ordering party is obligated to inspect the delivered goods for apparent flaws and report to us in writing any complaints with respect to such apparent flaws – this also applies to incomplete or incorrect deliveries – within one week after having received the goods; and, furthermore, with respect to flaws which only later become apparent, within one week after they have been detected by the ordering party. Otherwise, the goods shall be regarded as having been accepted, also with regard to apparent flaws, and the ordering party can thus not derive any rights therefrom with respect to us. This does not apply to a direct sale to a private consumer. In the event of legitimate notification of defects, we are obligated to rectification of the flaw of the delivered goods free of charge or, at our discretion, replacement delivery. If the rectification or replacement delivery fail despite two attempts, or if we unjustifiably refuse these or cause unconscionable delay, then the ordering party is entitled to abatement of the remuneration or, if construction work is not object of the liability for defects, to require rescission of the contract at his discretion.
 - 9.2 Claims for damages due material defects are governed by the following in Paragraph 11.
 - 9.3 Claims for defects are unwarranted if the flaw is traceable back to a violation of the operating, maintenance or installation specifications, unsuitable or improper use, incorrect or negligent handling by the ordering party and natural wear and tear, as well as due to intervention undertaken in the delivery item by the ordering party or third parties.
- 10. **Terms and conditions of payment and consequences in case of noncompliance, offsetting**
 - 10.1 Insofar as nothing to the contrary has been agreed, our accounts receivable are to be paid free of postage and other charges within 30 days after having received our invoice or an equivalent statement of accounts receivable, at the latest however 30 days after the due date and receipt of the consideration provided. For payments remitted thereafter we shall charge interest at an annual rate of 8%.
 - 10.2 In case of drafts and cheques, payment is only then regarded as having been remitted after the sum has been posted. Discounts and charges shall be borne by the ordering party.
 - 10.3 We shall only accept drafts and cheques on account of performance, and drafts only upon special agreement. Independent of the term period of accepted drafts or a granted forbearance, our accounts receivable are due immediately if the ordering party does not adhere to the terms and conditions of payment or circumstances that could cast doubt on his creditworthiness become known. Furthermore, in a case such as this we are authorised to only carry out deliveries against payment in advance or the provision of collateral, or to withdraw from the contract after a reasonable extended deadline, and/or to require indemnification.
 - 10.4 Only counterclaims that are undisputed or have been

legally determined to be valid can be offset by the ordering party vis-à-vis our accounts receivable. A right of retention is excluded unless the counterclaim is undisputed, has been stated as legally binding or is ready for decision.

- 11. **Liability for compensation (limitations and exclusions)**
 - 11.1 If essential contractual obligations - major obligations whose fulfilment allows the proper execution of the contract and on whose fulfilment the ordering party may rely - are breached, we shall also be liable in the event of simple negligence; however, any claims are limited to compensation for damages which were foreseeable and typical of the contract at the time of the contract conclusion.
 - 11.2 Otherwise - unless the breach of an essential contractual obligation is concerned and subject to the following Paragraph 11.4 - our liability for compensation shall be limited to damages resulting from a grossly negligent breach of duty on the part of our legal representatives or agents, regardless of the legal grounds and including an unlawful act, insofar as this involves culpability. Indirect damages or damages resulting from defects to the delivery item are only eligible for compensation if such damages are typically expected from the intended use of the delivery item.
 - 11.3 The aforementioned liability exclusions and limitations shall apply to the same extent in favour of our bodies, legal representatives, employees and other agents.
 - 11.4 The aforementioned liability exclusions and limitations shall not apply for damages as a result of injury to life, limb or health based on a negligent breach of duty on our part or an intentional or negligent breach of duty on the part of our legal representatives or agents. Similarly, claims from a warranty or according to the Product Liability Act shall not be affected by this.
- 12. **Place of performance, competent court of jurisdiction and applicable law**
 - 12.1 Place of performance is the location of our supplying factory.
 - 12.2 The place of jurisdiction for contracts with merchants, legal entities under public law and separate funds under public law is the registered office of the Bals contracting company. We reserve the right, however, to take action against the ordering party before the competent courts for his registered office.
 - 12.3 For all deliveries and services from German Bals companies, German law shall apply for transactions within the EU with the exception of the UN Convention on the International Sale of Goods; the UN Convention on the International Sale of Goods shall apply for international transactions with companies outside of the EU along with German law if the former does not contain any appropriate regulations. For Bals companies which are not based in Germany, the respective law in that country shall apply, with the UN Convention on the International Sale of Goods taking priority.

(Published in January 2019)

made
in
Germany



Simply. Well. Connected.

Bals Elektrotechnik GmbH & Co. KG
D-57399 Kirchhundem-Albaum
Phone: +49 27 23/771-0
Fax: +49 27 23/771-177/178
E-mail: info@bals.com
Internet: www.bals.com