

**QUALLCO**

PROFESSIONAL LIGHT COMPONENTS

2022

Dal 2010, anno di fondazione, QUALIKO Srl è riuscita a farsi conoscere sui mercati sia nazionali che internazionali come un'azienda seria e innovativa, attenta nel seguire e, in alcuni casi di anticipare, le scelte di un settore, quello dell'illuminazione, in continua evoluzione. Parte integrante del gruppo QLT con cui interagisce quotidianamente attingendo conoscenza tecnica e verifiche di laboratorio accurate. I nostri modelli infatti prima di essere immessi sul mercato vengono obbligatoriamente controllati da tecnici capaci e severi, i quali li testano applicando scrupolosamente le direttive vigenti. Tutti i prodotti sono assemblati con modulistica a LED e laddove vi siano solo dei componenti, questi sono adattabili alle nuovissime tipologie di lampadine. La continua ricerca di soluzioni tecniche ci ha portato ad avere prodotti sempre più performanti e innovativi, aumentando l'illuminamento e abbassando i consumi. Un esempio sono i nuovi prodotti realizzati in cemento e le applique LED interamente rivestite in foglia d'oro 24K. Tutti i prodotti della serie GYPSOLYTE, sia gli incassi invisibili che le LAMPADE A LED, possono essere dipinti insieme alla superficie in cui vengono posti diventandone parte integrante se illuminati e invisibili quando spenti; o ancora reinventando la luce, infatti con diversi nostri modelli se posizionati in precisi punti di una parete si ottengono dei giochi di luce capaci di rendere l'ambiente magico e moderno ma soprattutto personalizzato. Per questa ragione molte delle nostre creazioni hanno spesso suscitato stupore durante le manifestazioni fieristiche nazionali o internazionali a cui abbiamo partecipato. La nostra sede legale e operativa è a Rescaldina, in provincia di Milano, collegata da una fitta rete di contatti con il mondo intero e l'ufficio commerciale, composto da persone disponibili e professionalmente molto capaci, è in grado di intuire e risolvere ogni esigenza dei nostri Clienti.

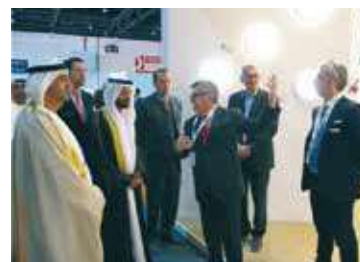

Since 2010, year of its first establishment, QUALIKO Srl has been known on both domestic and international markets as a serious and innovative company, careful to market trends and, in some cases anticipating the demand of the international lighting markets, which are in constant and fast evolution. QUALIKO is an important part of the QLT Group, with whom it interacts on a daily basis, exchanging technical knowledge and accurate laboratory tests. All QUALIKO products are deeply checked by skilled technicians who perform severe tests strictly in accordance with standards guidelines, before their release to the market. All products are designed to be used with LED sources. The continuous search for new technical solutions led QUALIKO products to be more and more efficient and innovative, with top performances in terms of flux and energy saving. A clear example are the new products made with concrete, an innovative material and the LED wall lamps completely covered with 24K gold leaves. Another plus from QUALIKO is the GYPSOLYTE series, both invisible fixtures and wall LED LAMPS, which can be easily painted with the same colour of the walls on which they are installed, integrating the architectural project itself, or even reinventing the light, by combining some products together (in specific positions) generating cosy light effects. For these reasons, many of our creations have often aroused curiosity during national or international exhibitions in which we exhibited. Our registered office and headquarter are in Rescaldina, near Milan. The Company is connected through a network of contacts with all international markets. The commercial department is composed of skilled professional people, able to sense and solve any Customer's need.

## Lampade a LED • LED lamps

FLYLINE	Pag.	2
LINEA 42	Pag.	4

## Lampade LED da tavolo portatile a batteria Battery operated table LED lamps

MIRTILLA	Pag.	6
MUSH	Pag.	8

## Sospensioni LED • LED Suspensions

LINEAR	Pag.	10
--------	------	----

## Smart Lighting

ROUND SMART	Pag.	12
ZERO 40 SMART	Pag.	13
LED PANEL 60x60 SMART	Pag.	14
	Pag.	15

## Lampade LED Gypsolyte • LED Gypsolyte lamps

FOLD LARGE	Pag.	16
FOLD SMALL	Pag.	18
FRAME ROUND	Pag.	20
FRAME SQUARE	Pag.	22
BRIDGE	Pag.	24
BRICK	Pag.	26
SHARD	Pag.	28
LOGOS	Pag.	30
BOB	Pag.	32
MOON EVO	Pag.	34
FLAG EVO	Pag.	36

## Lampade LED Cemento • LED Concrete lamps

FOLD	Pag.	38
FRAME SQUARE	Pag.	40
BRICK	Pag.	42
LOGOS	Pag.	44
BOB	Pag.	46

## Appliques LED da esterno • LED outdoor wall lamps

MOXY ONE	Pag.	48
MOXY TWO	Pag.	49
BLADE	Pag.	50
RAZOR	Pag.	51
GLOW	Pag.	52
	Pag.	53

## Gypsolyte • Gypsolyte fixtures

ARAGON	Pag.	54
ARAGON XL	Pag.	56
ARAGON GLASS	Pag.	58
ARAGON FLAT	Pag.	60
ARAGON TWIN	Pag.	62
OBLÒ	Pag.	64
OBLÒ XL	Pag.	66
OBLÒ GLASS	Pag.	68
OBLÒ FLAT	Pag.	70
SLIDE	Pag.	72
DIAGONAL	Pag.	74
BEAT	Pag.	76
SOUL	Pag.	78
SNAP	Pag.	80
LOOP	Pag.	82
NEOS	Pag.	84
ARGO	Pag.	86

## Incassi LED • LED downlights

ROUND	Pag.	88
ORION	Pag.	90
LAKE	Pag.	92
OPERA	Pag.	94
KARMA	Pag.	96
EASY CCT ROUND	Pag.	98
EASY CCT SQUARE	Pag.	100
TUNE CCT	Pag.	102

## Pannelli LED • LED Panels

LED PANEL DRI 60x60	Pag.	104
LED PANEL 60x60 - 60x120	Pag.	106
LED PANEL 30x30 - 30x60 - 30x120	Pag.	108
LED PANEL 60x60 FRAMELESS	Pag.	110
PAN HOLE 60x60	Pag.	112
LED PANEL RGB	Pag.	114

## Plafoniere LED • LED fixtures

WALLY	Pag.	116
WALLY RGB	Pag.	118
FLAX EVO	Pag.	120
FUTURA	Pag.	122
ZERO	Pag.	124
JAZZ	Pag.	126
BILLY CCT	Pag.	128
PIXY	Pag.	130
ZEUS	Pag.	132

## Campane LED • LED High Bay HIGH BAY EVO3

	Pag.	134
--	------	-----

## Proiettori LED • LED floods

GIANT EVO	Pag.	136
KANSAS	Pag.	138
SLIM EVO	Pag.	140

## Lampioni LED • LED street lights

ALASKA EVO	Pag.	142
TEXAS EVO	Pag.	144

## Alluminio • Aluminium fixtures

SWING	Pag.	146
GLAM	Pag.	148
FLIP	Pag.	150
MAYA	Pag.	152
BABEL	Pag.	154
BASIC	Pag.	156
INKA	Pag.	158
TEBE	Pag.	160
ECLYPSE	Pag.	162
ZENITH	Pag.	164

## LAMPADINE

	Pag.	166
--	------	-----

## KITS

Prodotti in esaurimento	Pag.	168
Discontinued products (end series)	Pag.	171
Condizioni di Garanzia • Guarantee conditions	Pag.	178

Disponibili files ottici Eulumdat (.ldt) e IESNA (.ies)

Available files: Eulumdat (.ldt) and IESNA (.ies)

Eulumdat (.ldt) und IESNA (.ies) files verfügbar

Documentation disponible: Eulumdat (.ldt) et IESNA (.ies)

Disponibles archives: Eulumdat (.ldt) e IESNA (.ies)





Vedere pagina 168 per i kit che includono la strip LED - See page 168 for kits including LED strip



Type	Part N°	Reel (mm)	Packing box dimensions (mm)	Weight (kg)
FLYLINE	BFLYLINE10PN	10.000	460x420x40	1,50

**Italy Flyline**

Il kit Flyline crea una illuminazione lineare sospesa di grande effetto. Mediante l'utilizzo di una strip LED (non inclusa) può essere utilizzato come wall-washer, sia in modo diretto che indiretto. Particolarmente adatto per illuminare musei, negozi, gallerie d'arte, hotel.

I raccordi permettono di orientare il prodotto sia verso l'alto, che verso il basso tramite gli appositi morsetti forniti.

Il kit comprende 10 metri di nastro per supporto strip LED e i supporti di fissaggio a parete.

Il kit NON comprende strip LED e relativo alimentatore, che vanno ordinati a parte.

**UK Flyline**

The Flyline kit creates an impressive suspended linear lighting.

By using a LED strip (not included) it can be used as a wall washer, both directly and indirectly.

Particularly suitable for lighting museums, shops, art galleries, hotel.

The fittings allow you to orient the product both upwards and downwards using the specific clamps provided.

The kit includes 10 meters of tape for LED strip support and wall fixing supports.

The kit does NOT include LED strips and its power supply, which should be ordered separately.

**Germany Flyline**

Das Flyline-Kit erzeugt eine beeindruckende hängende lineare Beleuchtung.

Durch die Verwendung einer LED-Streife (separat geliefert) kann es als Wall-Washer, sowohl direkt als auch indirekt, verwendet werden.

Besonders geeignet für die Beleuchtung von Museen, Geschäften, Kunstgalerien, Hotel.

Mit den Beschlägen können Sie das Produkt sowohl nach oben, und nach unten mit den mitgelieferten speziellen Klemmen orientieren.

Das Kit enthält 10 Meter Klebeband für Halterung für LED-Streifen und Halterungen für die Wandbefestigung.

Das Kit enthält KEINE LED-Streifen und deren Netzteil, die separat bestellt sein sollten.

**France Flyline**

Le kit Flyline crée un exceptionnel éclairage linéaire en suspension.

En utilisant une bande de LED (non incluse), il peut être utilisé en tant que lèche-mur, à la fois directement ou indirectement.

Particulièrement adapté à l'éclairage des musées, magasins, galeries d'art, hôtellerie.

Les supports de fixation murale fournis permettent d'orienter le produit aussi bien vers l'haup que vers le bas.

Le kit comprend 10 mètres de support pour la bande de LED et l'ensemble des fixations murales.

Le kit ne comprend pas la bande de LED et son alimentation qui doivent être commandés séparément.

**Spain Flyline**

El kit Flyline crea una impresionante iluminación lineal suspendida.

Mediante el uso de una tira de LED (no incluida) se puede utilizar como bañador de pared, tanto directa como indirectamente.

Especialmente indicado para la iluminación de museos, tiendas, galerías de arte, hotel.

Los herrajes permiten orientar el producto tanto hacia arriba, y hacia abajo utilizando las abrazaderas específicas suministradas.

El kit incluye 10 metros de cinta para soporte tira LED y soportes de fijación a pared.

El kit NO incluye tiras LED y su fuente de alimentación, que van pedido por separado.

# LINEA 42

QUALIKO  
PROFESSIONAL LIGHT COMPONENTS  
srl



Lampada da terra a LED  
Floor lamp LED

## LINEA 42 Lampada da terra a LED • Floor lamp LED

QUALIKO<sup>®</sup>

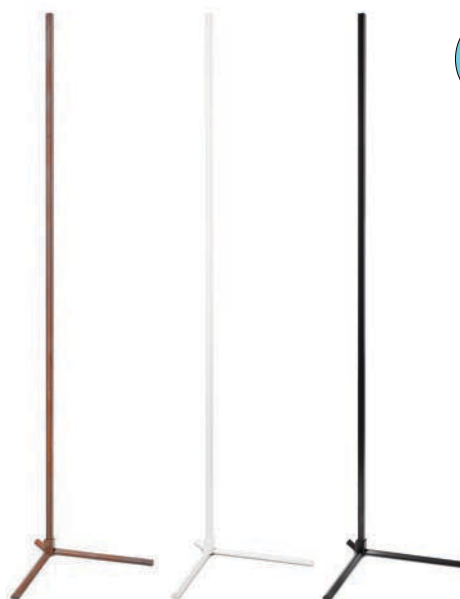

CLASS 2  IP20 RoHS

Type	Part N°	Input (V)	Power (W)	Lumen	Light Colour	°Kelvin (±10%)	CRI	Dimensions (mm)	Packing box dimensions (mm)	Weight (kg)
LINEA 42 WHITE	<b>BLINEA42L27B</b>	190÷240 AC	42,5	3415	WW	2700°K	>80	530x36x1815h	ø80x1850h	3,975
LINEA 42 BLACK	<b>BLINEA42L27N</b>	190÷240 AC	42,5	3415	WW	2700°K	>80	530x36x1815h	ø80x1850h	3,975
LINEA 42 CORTEN	<b>BLINEA42L27M</b>	190÷240 AC	42,5	3415	WW	2700°K	>80	530x36x1815h	ø80x1850h	3,975

### Linea 42

È una lampada da terra non convenzionale. Disegnata per ottenere un'illuminazione indiretta, proiettata verso gli angoli delle pareti. Il risultato è un'atmosfera soffusa e rilassante, grazie ai LED ad altissima efficienza ed alla dimmerabilità.

### Linea 42

Is an unconventional floor lamp. Designed for indirect lighting, projected towards the corners of the walls. The result is a soft and relaxing atmosphere, thanks to the highly efficient LEDs and dimmable feature.

### Linea 42

Ist eine unkonventionelle Stehlampe. Gedacht für indirekte Beleuchtung, die in Richtung der Ecken der Wände gerichtet ist. Das Ergebnis ist eine weiche und entspannende Atmosphäre dank der hocheffizienten LEDs und der Dimmbarkeit.

### Linea 42

Est un luminaire de sol originale. Conçue pour obtenir un éclairage indirect, projeté vers l'angle des murs. Le résultat est une atmosphère douce et relaxante, grâce à des LED très efficaces et à leur réglage.

### Linea 42

Es una lámpara de pie poco convencional. Diseñado para obtener iluminación indirecta, proyectada hacia las esquinas de las paredes. El resultado es una atmósfera suave y relajante, gracias a los LED de alta eficiencia y la regulabilidad.



# MIRTILLA

QUALIKO  
PROFESSIONAL LIGHT COMPONENTS  
srl

Lampada LED da tavolo portatile a batteria  
Battery operated table LED lamp





# MIRTILLA Lampada LED da tavolo portatile a batteria Battery operated table LED lamp

QUALIKO<sup>®</sup>



CLASS 3   IP54 RoHS

Type	Part N°	Power (W)	Lumen	Light Colour	°Kelvin (±10%)	CRI	Dimensions (mm)	Packing box dimensions (mm)	Weight (kg)
MIRTILLA WHITE	<b>BTL28622T30B</b>	2	183	WW	3000°K	>80	135X300h	145X145X310h	1,2
MIRTILLA BLACK	<b>BTL28622T30N</b>	2	183	WW	3000°K	>80	135X300h	145X145X310h	1,2
MIRTILLA LIGHT BLUE	<b>BTL28622T30A</b>	2	183	WW	3000°K	>80	135X300h	145X145X310h	1,2
MIRTILLA CORTEN	<b>BTL28622T30R</b>	2	183	WW	3000°K	>80	135X300h	145X145X310h	1,2

## Mirtilla

È una lampada da tavolo ricaricabile e dimmerabile a tocco, con corpo in alluminio verniciato. La luce è modulabile su tre livelli di intensità 10% (50 ore) 40% (10 ore), 100% (4 ore).

Funzionamento a batteria 1x2600mA LHON 3,7V

Tempo di ricarica: 3 ore (1A)

Adatta ad un uso sia interno che esterno grazie al grado di protezione IP54.

Nella confezione è incluso un caricatore USB - 100÷240 AC

## Mirtilla

Is a rechargeable and dimmable by touch table lamp, with painted aluminum body. Suitable for both indoor and outdoor use thanks to the IP54 protection degree. The light can be modulated on three levels of intensity 10% (50 hours) 40% (10 hours), 100% (4 hours).

Battery operated 1x2600mA LHON 3,7V

Charging time: 3 hours (1A)

A USB charger is included in the package - 100÷240 AC

## Mirtilla

Ist eine wiederaufladbare und durch Berührung dimmbare Tischlampe mit lackiertem Aluminiumgehäuse. Dank der Schutzart IP54 ist die sowohl für den Innen- als auch für den Außenbereich geeignet. Das Licht kann auf drei Intensitätsstufen geregelt werden: 10% (50 Stunden), 40% (10 Stunden), 100% (4 Stunden).

Batteriebetrieb: 1x2600mA LHON 3,7V

Ladezeit: 3 Stunden (1A)

Ein USB-Ladegerät ist im Lieferverpackung enthalten - 100÷240 AC

## Mirtilla

Est un luminaire de table dimmable tactile et rechargeable en aluminium peint. Utilisation à l'intérieur et aussi à l'extérieur grâce à

sa protection IP54. Il a trois niveaux d'intensité de la lumière: 10% (50heures), 40% (10 heures), 100% (4heures).

Fonctionnement avec batterie 1x2600mA LHON 3,7V

Tiempo de carga: 3 horas (1A)

Dans son emballage est inclu un chargeur USB - 100÷240 AC

## Mirtilla

Es una lámpara se sobremesa táctil recargable y regulable, con cuerpo en aluminio pintado. La luz se puede modular en tres niveles de intensidad 10% (50 horas), 40% (10 horas), 100% (4 horas). Adecuado para uso interior como exterior gracias al grado de protección IP54.

Funciona con batería 1x2600mA LHON 3,7V

Tiempo de carga: 3 horas (1A)

El paquete incluye un cargador USB - 100÷240 AC

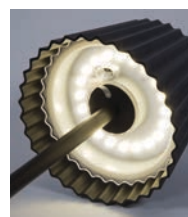

# MUSH

QUALIKO  
PROFESSIONAL LIGHT COMPONENTS  
srl



Lampada LED da tavolo  
portatile a batteria

Battery operated table LED lamp



CLASS 3   IP54 RoHS

Type	Part N°	Power (W)	Lumen	Light Colour	*Kelvin (±10%)	CRI	Dimensions (mm)	Packing box dimensions (mm)	Weight (kg)
MUSH	BTL28112T30B	2	270	WW	3000°K	>80	197x108x292h	220x220x250h	1,30

 **Lampada LED da tavolo portatile a batteria IP54**

- Struttura in alluminio
- Funzionamento a batteria 2x2200mAh LHON 3,7V
- Tempo di ricarica: 4,5 ore (1A)
- Tre livelli di luminosità 100% - 40% - 10%
- Autonomia: 100% = 6,5 ore • 40% = 15 ore • 10% = 80 ore
- Caricabatterie incluso - 100±240 AC

 **Battery-powered LED table lamp IP54**

- Aluminum structure
- Battery operated 2x2200mAh LHON 3.7V
- Charging time: 4.5 hours (1A)
- Three brightness levels: 100% - 40% - 10%
- Autonomy: 100% = 6.5 hours - 40% = 15 hours - 10% = 80 hours
- USB battery charger included - 100±240 AC

 **Batteriebetriebene LED Tischleuchte IP54**

- Aluminiumstruktur
- Batteriebetrieb: 2x2200mAh LHON 3.7V
- Ladezeit: 4,5 Stunden (1A)
- Drei Helligkeitsstufen: 100% - 40% - 10%
- Autonomie: 100% = 6,5 Stunden - 40% = 15 Stunden - 10% = 80 Stunden
- USB-Ladegerät enthalten - 100±240 AC

 **Lampe à Led à poser IP54 avec batterie**

- Corps en aluminium
- Fonctionnement avec batterie 2x2200mAh LHON 3,7V
- Temps de recharge: 4,5 heures (1A)
- Trois niveaux de luminosité: 100% - 40% - 10%
- Autonomie de la batterie: 100% = 6,5 heures - 40% = 15 heures - 10% = 80 heures
- Équipée de chargeur USB pour la batterie - 100±240 AC

 **Lámpara de mesa LED a batería IP54**

- Estructura de aluminio
- Funciona con batería 2x2200mAh LHON 3.7V
- Tiempo de carga: 4.5 horas (1A)
- Tres niveles de brillo: 100% - 40% - 10%
- Autonomía: 100% = 6.5 horas - 40% = 15 horas - 10% = 80 horas
- Cargador de batería USB incluido - 100±240 AC



# LINEAR

QUALIKO  
PROFESSIONAL LIGHT COMPONENTS  
srl

Sospensioni LED • LED suspension



CE EMC IP20 RoHS

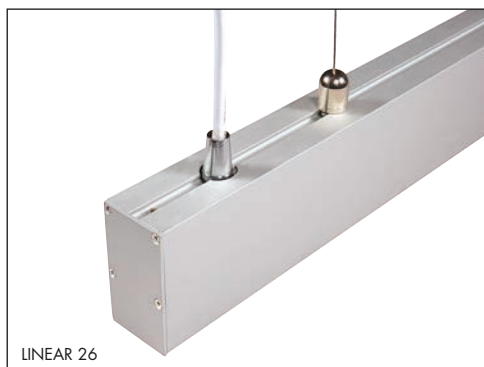

LINEAR 26



LINEAR 42

Type	Part N°	Dimensions (mm)	Input (V)	°Kelvin	Flux (Lm)	Power +/- (W Max)	Packing box dimensions (mm)	Weight (kg)
LINEAR 26 NW	<b>BLS3567A26NW</b>	1200x35x67h	230	4000°	2024	26	1290x115x90	2,10
LINEAR 26 WW	<b>BLS3567A26WW</b>	1200x35x67h	230	3000°	1778	26	1290x115x90	2,10
LINEAR 42 NW	<b>BLS4865A42NW</b>	1200x48x65h	230	4000°	3838	42	1300x110x95	2,80
LINEAR 42 WW	<b>BLS4865A42WW</b>	1200x48x65h	230	3000°	3305	42	1300x110x95	2,80

**🇮🇹 Sospensione LED per interni**

- Schermo in Policarbonato e corpo in alluminio.
- Applicazioni tipiche: abitazioni, uffici, laboratori, etc.
- CRI>80

**🇬🇧 LED suspension for interiors**

- Polycarbonate screen, aluminium body.
- Typical applications: homes, office, laboratories, etc.
- CRI>80

**🇩🇪 Lineare Pendelleuchten**

- Schirm aus Polycarbonat und Körper aus Aluminium.
- Typische Anwendungen: Wohnungen, Büros, Workshops, usw.
- CRI>80

**🇫🇷 Sospensione LED pour usage intérieur**

- Écran en polycarbonate et corps en aluminium.
- Applications typiques: maisons, bureaux, laboratoires, etc.
- IRC>80

**🇪🇸 Suspensión LED para interiores**

- Pantalla de Policarbonato, cuerpo de aluminio.
- Aplicaciones típicas: viviendas, oficinas, laboratorios, etc.
- CRI>80





# SMART LIGHTING

QUALIKO  
PROFESSIONAL LIGHT COMPONENTS srl

















 Controllo totale della luce da remoto - intensità, colore, scenari - tramite App da dispositivi Smart, Amazon Echo e Google Home

 Total remote control of light - intensity, color, scenarios - via Apps from Smart devices, Amazon Echo and Google Home

 Fernsteuerung des Lichts - der Helligkeit, Farbe und Szenarien - durch Smartgeräte, Amazon Echo und Google Home

 Contrôle total de la lumière - intensité, couleur, scénarios - par applications sur dispositifs Smart, Amazon Echo et Google Home

 Control remoto total de la luz - intensidad, color, escenarios - a través de aplicaciones de dispositivos inteligentes, Amazon Echo y Google Home

 Beam Angle	 AC xxx-xxxV Voltage	 PF2xxx Power Factor
 CRI2xxx CRI	 IPxx Protection	 2.4G 2.4G Intelligent Control
 WiFi Intelligent Control	 Smart Lighting Smart Lighting	 Dimmable
 Tunable White Tunable White	 Voice Control Voice Control	 Voice Control Voice Control
 Amazon Echo	 Google Home	
 tuya Smart Life	 GET IT ON Google Play	 Download on the App Store

# ROUND SMART

QUALIKO



IP54 RoHS



Smart Life

Type	Part N°	Dimensions (mm)	Colour	° Kelvin	Lumen	Power (W)	Input (V)	CRI	IP	mm	Packing box dimensions (mm)	Weight (kg)
ROUND SMART 10W	<b>BDL2103SM10B</b>	Ø 110x30h	CCT	3000±5700°K	980	10	200±240 AC	>80	54	Ø 90±95	125x125x80h	0,29
ROUND SMART 18W	<b>BDL2104SM18B</b>	Ø 145x30h	CCT	3000±5700°K	1950	18	200±240 AC	>80	54	Ø 120±130	155x155x90h	0,40
ROUND SMART 35W	<b>BDL2108SM35B</b>	Ø 225x34hh	CCT	3000±5700°K	3900	35	200±240 AC	>80	54	Ø 200±210	230x270x75h	0,80

## Incasso a LED tondo ad alta potenza SMART

- Temperatura di colore regolabile da bianco caldo a bianco freddo
- Dimmerabile dall'1% al 100% di luminosità
- Controllo remoto da qualsiasi luogo tramite app vocale o smartphone (Tuya - Smart Life) o Amazon Echo o Google Home
- Seleziona liberamente qualsiasi scena luminosa
- Risparmio energetico ottenuto con la funzione di programmazione
- Driver esterno

## Focos empotrables a LED de alta potencia SMART

- Temperatura de color ajustable de blanco cálido a blanco frío
- Regulable de 1% a 100%
- Control remoto desde cualquier lugar a través de la aplicación de voz o teléfono inteligente (Tuya - Smart Life) o Amazon Echo o Google Home
- Selección libremente cualquier escena de iluminación
- Ahorro de energía logrado con la función de programación
- Transformador externo

## Round extra powerful recessed SMART LED downlight

- Tunable color temperature from warm white to cool white
- Dimmable from 1% to 100% brightness
- Control remotely from anywhere via voice or smartphone app (Tuya - Smart Life) or Amazon Echo or Google Home
- Freely select any lighting scenes
- Energy saving achieved with programmable function
- External driver

## SMART LED Rundeinbaustrahler

- Einstellbare Farbtemperatur von warmweiß bis kaltweiß
- Dimmbar von 1% bis 100% Helligkeit
- Über Sprach- oder Smartphone-App (Tuya - Smart Life), Amazon Echo, Google Home von überall aus fernsteuern
- Beliebige Lichtszenen frei wählen
- Energieeinsparung durch programmierbare Planungsfunktion
- Netzteil außen montiert

## Encastrement LED rond SMART haute puissance

- Réglage de la température de couleur de blanc chaud à blanc froid
- Luminosité réglable de 1% à 100%
- Contrôle par application vocal ou Smartphone (Tuya - Smart Life) ou Amazon Echo ou Google Home
- Sélection libre de n'importe quelle scène de lumière
- Économie d'énergie par la fonction de programmation
- Équipé de driver extérieur



Connettere direttamente a 200±240V  
Connect direct to 200±240V



Smart Life

Type	Part N°	Dimensions (mm)	Colour	° Kelvin	Lumen	Power (W)	Input (V)	CRI	IP	Packing box dimensions (mm)	Weight (kg)
ZERO 40 SMART	BZEROSM40030	Ø400x52h	CCT	3000±5700°K	3480	30	100±240 AC	>80	54	410x410x60	1,75

### 🇮🇹 Plafoniera LED per uso esterno IP54 SMART

- Temperatura di colore regolabile da bianco caldo a bianco freddo
- Dimmerabile dall'1% al 100% di luminosità
- Controllo remoto da qualsiasi luogo tramite app vocale o smartphone (Tuya - Smart Life) o Amazon Echo o Google Home
- Seleziona liberamente qualsiasi scena luminosa
- Risparmio energetico ottenuto con la funzione di programmazione
- Driver interno

### 🇬🇧 IP54 LED SMART fixture for outdoor use

- Tunable color temperature from warm white to cool white
- Dimmable from 1% to 100% brightness
- Control remotely from anywhere via voice or smartphone app (Tuya - Smart Life) or Amazon Echo or Google Home
- Freely select any lighting scenes
- Energy saving achieved with programmable function
- Internal driver

### 🇩🇪 SMART LED Anbau-Leuchte für Außeninstallation IP54

- Einstellbare Farbtemperatur von warmweiß bis kaltweiß
- Dimmbar von 1% bis 100% Helligkeit
- Über Sprach- oder Smartphone-App (Tuya - Smart Life), Amazon Echo, Google Home von überall aus fernsteuern
- Beliebige Lichtszenen frei wählen
- Energieeinsparung durch programmierbare Planungsfunktion
- Eingebauten Netzteil.

### 🇫🇷 Plafonniers LED SMART pour l'extérieur IP54

- Réglage de la température de couleur de blanc chaud à blanc froid
- Luminosité réglable de 1% à 100%
- Contrôle par application vocal ou Smartphone (Tuya - Smart Life) ou Amazon Echo ou Google Home
- Sélection libre de n'importe quelle scène de lumière
- Économie d'énergie par la fonction de programmation
- Équipé de driver à l'intérieur

### 🇪🇸 Lámparas de techo/pared LED IP54 SMART

- Temperatura de color ajustable de blanco cálido a blanco frío
- Regulable de 1% a 100%
- Control remoto desde cualquier lugar a través de la aplicación de voz o teléfono inteligente (Tuya - Smart Life) o Amazon Echo o Google Home
- Selección libremente cualquier escena de iluminación
- Ahorro de energía logrado con la función de programación
- Transformador integrado





# LED PANEL 60x60 SMART

QUALIKO<sup>®</sup>



CE EMC IP 40 RoHS

Optional: suspension kit - Part N°: BPLKIT4X150C



Optional: ceiling kit - Part N°: BPLKITCEIL1B

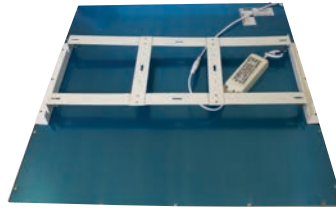

Optional: wall kit - Part N°: BPLKITWALL0B

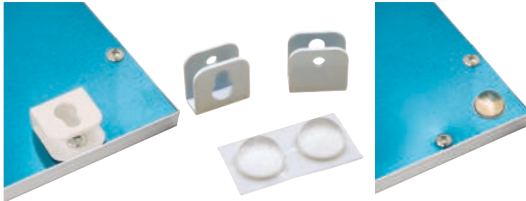

Optional: spring kit Part N°: BPLKITSRING



Optional: closed ceiling kit (60x60 only)



Type	Part N°	Dimensions (mm)	Input (V)	Frame colour	°Kelvin	Lumen	Power (W)	Packing box dimensions (mm)	Weight (kg)
60x60 SMART	<b>BPL6060SMART</b>	595x595x9h	200÷240AC	White	3000°K ÷ 5700°K	3315÷3539	33	710x640x30h	3,0



Smart Life

## 🇮🇹 Pannello LED 60x60 DRI SMART

- Temperatura di colore regolabile da bianco caldo a bianco freddo
- Dimmerabile dall'1% al 100% di luminosità
- Controllo remoto da qualsiasi luogo tramite app vocale o smartphone (Tuya - Smart Life) o Amazon Echo o Google Home
- Seleziona liberamente qualsiasi scena luminosa
- Risparmio energetico ottenuto con la funzione di programmazione

## 🇬🇧 LED panel 60x60 DRI SMART

- Tunable color temperature from warm white to cool white
- Dimmable from 1% to 100% brightness
- Control remotely from anywhere via voice or smartphone app (Tuya - Smart Life) or Amazon Echo or Google Home
- Freely select any lighting scenes
- Energy saving achieved with programmable function

## 🇩🇪 LED-Tafel 60x60 DRI SMART

- Einstellbare Farbtemperatur von warmweiß bis kaltweiß
- Dimmbar von 1% bis 100% Helligkeit
- Über Sprach- oder Smartphone-App (Tuya - Smart Life), Amazon Echo, Google Home von überall aus fernsteuern
- Beliebige Lichtszenen frei wählen
- Energieeinsparung durch programmierbare Planungsfunktion

## 🇫🇷 Panneau LED 60x60 DRI SMART

- Réglage de la température de couleur de blanc chaud à blanc froid
- Luminosité réglable de 1% à 100%
- Contrôle par application vocal ou Smartphone (Tuya - Smart Life) ou Amazon Echo ou Google Home
- Sélection libre de n'importe quelle scène de lumière
- Économie d'énergie par la fonction de programmation

## 🇪🇸 Panel LED 60x60 DRI SMART

- Temperatura de color ajustable de blanco cálido a blanco frío
- Regulable de 1% a 100%
- Control remoto desde cualquier lugar a través de la aplicación de voz o teléfono inteligente (Tuya - Smart Life) o Amazon Echo o Google Home
- Selección libremente cualquier escena de iluminación
- Ahorro de energía logrado con la función de programación

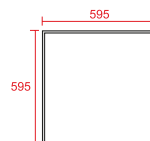

# FOLD LARGE

QUALIKO<sup>srl</sup>  
PROFESSIONAL LIGHT COMPONENTS



Lampade LED Gypsolyte • LED Gypsolyte lamps

Made in Italy



**IP20** EMC RoHS

Type	Part N°	Input (V)	Power (W)	Lumen	Light Colour	°Kelvin (±10%)	CRI	Dimensions (mm)	Packing box dimensions (mm)	Weight (kg)
FOLD LARGE	<b>BW8422GLEDNW</b>	190÷265 AC	31±1	3800	NW	4000°K	>80	135x300x300h	380x370x160h	3,00
FOLD LARGE	<b>BW8422GLEDWW</b>	190÷265 AC	31±1	3650	WW	3000°K	>80	135x300x300h	380x370x160h	3,00
FOLD LARGE GOLD	<b>BW8422GOLDNW</b>	190÷265 AC	31±1	3800	NW	4000°K	>80	135x300x300h	380x370x160h	3,00
FOLD LARGE GOLD	<b>BW8422GOLDWW</b>	190÷265 AC	31±1	3650	WW	3000°K	>80	135x300x300h	380x370x160h	3,00
FOLD LARGE CORTEN	<b>BW8422RUSTNW</b>	190÷265 AC	31±1	3800	NW	4000°K	>80	135x300x300h	380x370x160h	3,00
FOLD LARGE CORTEN	<b>BW8422RUSTWW</b>	190÷265 AC	31±1	3650	WW	3000°K	>80	135x300x300h	380x370x160h	3,00

**Applique LED**

- Struttura in Gypsolyte
- Grande omogeneità luminosa
- Funziona in bassa tensione con trasformatore incorporato
- Consumo molto limitato
- Lunga durata

**LED wall lamp**

- Structure in Gypsolyte
- Homogeneous light output
- Safety low voltage with specific included driver
- Limited consumption
- Long life time

**LED Wandleuchte**

- Struktur in Gypsolyte
- Homogenes Licht
- NV-Betrieb durch besonderen Transformator
- Begrenzter Verbrauch
- Lange Lebensdauer

**Applique LED**

- Corps en Gypsolyte
- Luminosité très homogène
- Il marche en basse tension avec alimentation intégrée
- Consommation très limitée
- Longue durée de vie

**Lamparas de pared LED**

- Estructura de Gypsolyte
- Excelente homogeneidad luminica
- Alta seguridad por funcionamiento a baja tension, con transformador integrado
- Consumo muy limitado- Larga vida

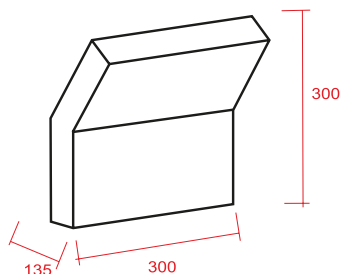

# FOLD SMALL

QUALIKO<sup>srl</sup>  
PROFESSIONAL LIGHT COMPONENTS

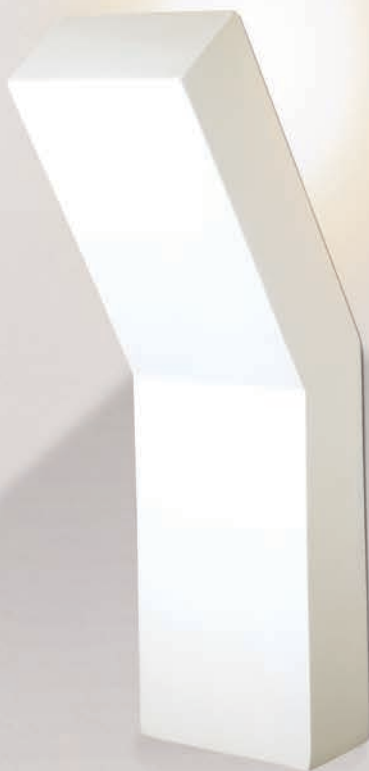

Lampade LED Gypsolyte • LED Gypsolyte lamps

Made in Italy



CE IP20 EMC RoHS

Type	Part N°	Input (V)	Power (W)	Lumen	Light Colour	°Kelvin (±10%)	CRI	Dimensions (mm)	Packing box dimensions (mm)	Weight (kg)
FOLD SMALL	<b>BW8421GLEDNW</b>	100÷250 AC	10±1	840	NW	4000°K	>80	135x80x300h	370x150x140h	1,30
FOLD SMALL	<b>BW8421GLEDWW</b>	100÷250 AC	10±1	800	WW	3000°K	>80	135x80x300h	370x150x140h	1,30
FOLD SMALL GOLD	<b>BW8421GOLDNW</b>	100÷250 AC	10±1	840	NW	4000°K	>80	135x80x300h	370x150x140h	1,30
FOLD SMALL GOLD	<b>BW8421GOLDWW</b>	100÷250 AC	10±1	800	WW	3000°K	>80	135x80x300h	370x150x140h	1,30

**Applique LED**

- Struttura in Gypsolyte
- Grande omogeneità luminosa
- Funziona in bassa tensione con trasformatore incorporato
- Consumo molto limitato
- Lunga durata

**LED wall lamp**

- Structure in Gypsolyte
- Homogeneous light output
- Safety low voltage with specific included driver
- Limited consumption
- Long life time

**LED Wandleuchte**

- Struktur in Gypsolyte
- Homogenes Licht
- NV-Betrieb durch besonderen Transformator
- Begrenzter Verbrauch
- Lange Lebensdauer

**Appique LED**

- Corps en Gypsolyte
- Luminosité très homogène
- Il marche en basse tension avec alimentation intégrée
- Consommation très limitée
- Longue durée de vie

**Lamparas de pared LED**

- Estructura de Gypsolyte
- Excelente homogeneidad luminica
- Alta seguridad por funcionamiento a baja tension, con transformador integrado
- Consumo muy limitado- Larga vida

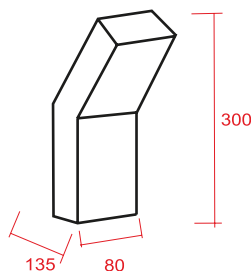

# FRAME ROUND

QUALIKO<sup>srl</sup>  
PROFESSIONAL LIGHT COMPONENTS



Lampade LED Gypsolyte • LED Gypsolyte lamps

# FRAME ROUND Lampade LED Gypsolyte • LED Gypsolyte lamps

QUALIKO

Made in Italy



CE IP20 EMC RoHS

Type	Part N°	Input (V)	Power (W)	Lumen	Light Colour	°Kelvin (±10%)	CRI	Dimensions (mm)	Packing box dimensions (mm)	Weight (kg)
FRAME RD	<b>BW8439GLEDNW</b>	100÷250 AC	8±1	930	NW	4000°K	>80	202x150x50h	245x205x105h	1,10
FRAME RD	<b>BW8439GLEDWW</b>	100÷250 AC	8±1	890	WW	3000°K	>80	202x150x50h	245x205x105h	1,10
FRAME RD GOLD	<b>BW8439GOLDNW</b>	100÷250 AC	8±1	930	NW	4000°K	>80	202x150x50h	245x205x105h	1,10
FRAME RD GOLD	<b>BW8439GOLDWW</b>	100÷250 AC	8±1	890	WW	3000°K	>80	202x150x50h	245x205x105h	1,10

## 🇮🇹 Applique LED

- Struttura in Gypsolyte
- Grande omogeneità luminosa
- Funziona in bassa tensione con trasformatore incorporato
- Consumo molto limitato
- Lunga durata

## 🇬🇧 LED wall lamp

- Structure in Gypsolyte
- Homogeneous light output
- Safety low voltage with specific included driver
- Limited consumption
- Long life time

## 🇩🇪 LED Wandleuchte

- Struktur in Gypsolyte
- Homogenes Licht
- NV-Betrieb durch besonderen Transformator
- Begrenzter Verbrauch
- Lange Lebensdauer

## 🇫🇷 Applique LED

- Corps en Gypsolyte
- Luminosité très homogène
- Il marche en basse tension avec alimentation intégrée
- Consommation très limitée
- Longue durée de vie

## 🇪🇸 Lamparas de pared LED

- Estructura de Gypsolyte
- Excelente homogeneidad luminica
- Alta seguridad por funcionamiento a baja tension, con transformador integrado
- Consumo muy limitado
- Larga vida

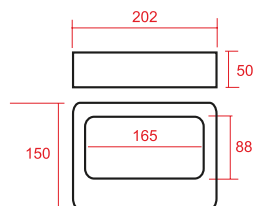

## FRAME ROUND

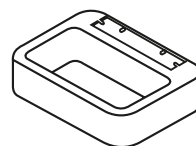

# FRAME SQUARE

QUALIKO<sup>srl</sup>  
PROFESSIONAL LIGHT COMPONENTS



Lampade LED Gypsolyte • LED Gypsolyte lamps



 Made in Italy



 **IP20** EMC RoHS

Type	Part N°	Input (V)	Power (W)	Lumen	Light Colour	°Kelvin (±10%)	CRI	Dimensions (mm)	Packing box dimensions (mm)	Weight (kg)
FRAME SQ	<b>BW8438GLEDNW</b>	100÷250 AC	8±1	930	NW	4000°K	>80	222x150x50h	265x210x110h	1,30
FRAME SQ	<b>BW8438GLEDWW</b>	100÷250 AC	8±1	890	WW	3000°K	>80	222x150x50h	265x210x110h	1,30
FRAME SQ GOLD	<b>BW8438GOLDNW</b>	100÷250 AC	8±1	930	NW	4000°K	>80	222x150x50h	265x210x110h	1,30
FRAME SQ GOLD	<b>BW8438GOLDWW</b>	100÷250 AC	8±1	890	WW	3000°K	>80	222x150x50h	265x210x110h	1,30

 **Applique LED**

- Struttura in Gipsolyte
- Grande omogeneità luminosa
- Funziona in bassa tensione con trasformatore incorporato
- Consumo molto limitato
- Lunga durata

 **LED wall lamp**

- Structure in Gipsolyte
- Homogeneous light output
- Safety low voltage with specific included driver
- Limited consumption
- Long life time

 **LED Wandleuchte**

- Struktur in Gipsolyte
- Homogenes Licht
- NV-Betrieb durch besonderen Transformator
- Begrenzter Verbrauch
- Lange Lebensdauer

 **Applique LED**

- Corps en Gipsolyte
- Luminosité très homogène
- Il marche en basse tension avec alimentation intégrée
- Consommation très limitée
- Longue durée de vie

 **Lamparas de pared LED**

- Estructura de Gipsolyte
- Excelente homogeneidad luminica
- Alta seguridad por funcionamiento a baja tension, con transformador integrado
- Consumo muy limitado
- Larga vida

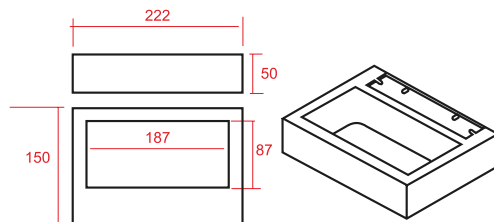



Lampade LED Gypsolyte • LED Gypsolyte lamps

Made in Italy



IP20 EMC RoHS

Type	Part N°	Input (V)	Power (W)	Lumen	Light Colour	°Kelvin (±10%)	CRI	Dimensions (mm)	Packing box dimensions (mm)	Weight (kg)
BRIDGE	<b>BW8430GLEDNW</b>	100÷250 AC	15±1	1530	NW	4000°K	>80	318x134x56h	370x210x100h	1,60
BRIDGE	<b>BW8430GLEDWW</b>	100÷250 AC	15±1	1485	VV	3000°K	>80	318x134x56h	370x210x100h	1,60
BRIDGE GOLD	<b>BW8430GOLDNW</b>	100÷250 AC	15±1	1530	NW	4000°K	>80	318x134x56h	370x210x100h	1,60
BRIDGE GOLD	<b>BW8430GOLDWW</b>	100÷250 AC	15±1	1485	VV	3000°K	>80	318x134x56h	370x210x100h	1,60

**Applicque LED**

- Struttura in Gypsolyte
- Grande omogeneità luminosa
- Funziona in bassa tensione con trasformatore incorporato
- Consumo molto limitato
- Lunga durata

**LED wall lamp**

- Structure in Gypsolyte
- Homogeneous light output
- Safety low voltage with specific included driver
- Limited consumption
- Long life time

**LED Wandleuchte**

- Struktur in Gypsolyte
- Homogenes Licht
- NV-Betrieb durch besonderen Transformator
- Begrenzter Verbrauch
- Lange Lebensdauer

**Applicque LED**

- Corps en Gypsolyte
- Luminosité très homogène
- Il marche en basse tension avec alimentation intégrée
- Consommation très limitée
- Longue durée de vie

**Lamparas de pared LED**

- Estructura de Gypsolyte
- Excelente homogeneidad luminica
- Alta seguridad por funcionamiento a baja tension, con transformador integrado
- Consumo muy limitado- Larga vida

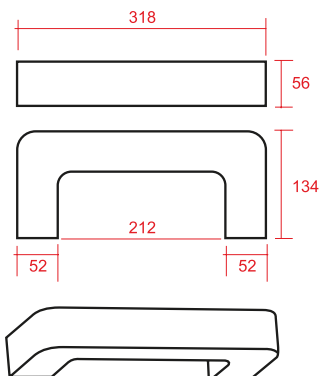



Lampade LED Gypsolyte • LED Gypsolyte lamps

 Made in Italy



**CE** **IP20** EMC RoHS

Type	Part N°	Input (V)	Power (W)	Lumen	Light Colour	°Kelvin (±10%)	CRI	Dimensions (mm)	Packing box dimensions (mm)	Weight (kg)
BRICK	<b>BW8211GLEDNW</b>	100÷250 AC	12±1	1310	NW	4000°K	>80	275x94x57h	340x150x120h	1,30
BRICK	<b>BW8211GLEDWW</b>	100÷250 AC	12±1	1250	WW	3000°K	>80	275x94x57h	340x150x120h	1,30
BRICK GOLD	<b>BW8211GOLDNW</b>	100÷250 AC	12±1	1310	NW	4000°K	>80	275x94x57h	340x150x120h	1,30
BRICK GOLD	<b>BW8211GOLDWW</b>	100÷250 AC	12±1	1250	WW	3000°K	>80	275x94x57h	340x150x120h	1,30

 **Applicque LED**

- Struttura in Gypsolyte
- Grande omogeneità luminosa
- Funziona in bassa tensione con trasformatore incorporato
- Consumo molto limitato
- Lunga durata

 **LED wall lamp**

- Structure in Gypsolyte
- Homogeneous light output
- Safety low voltage with specific included driver
- Limited consumption
- Long life time

 **LED Wandleuchte**

- Struktur in Gypsolyte
- Homogenes Licht
- NV-Betrieb durch besonderen Transformator
- Begrenzter Verbrauch
- Lange Lebensdauer

 **Applicque LED**

- Corps en Gypsolyte
- Luminosité très homogène
- Il marche en basse tension avec alimentation intégrée
- Consommation très limitée
- Longue durée de vie

 **Lamparas de pared LED**

- Estructura de Gypsolyte
- Excelente homogeneidad luminica
- Alta seguridad por funcionamiento a baja tension, con transformador integrado
- Consumo muy limitado- Larga vida

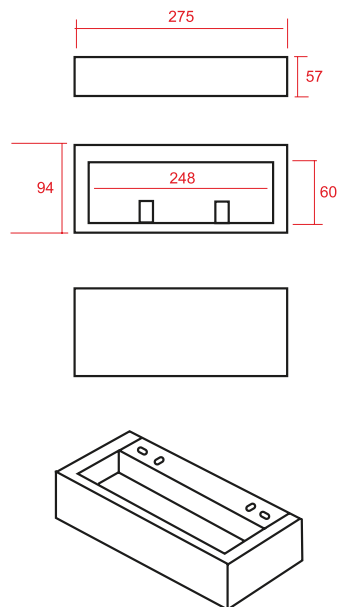

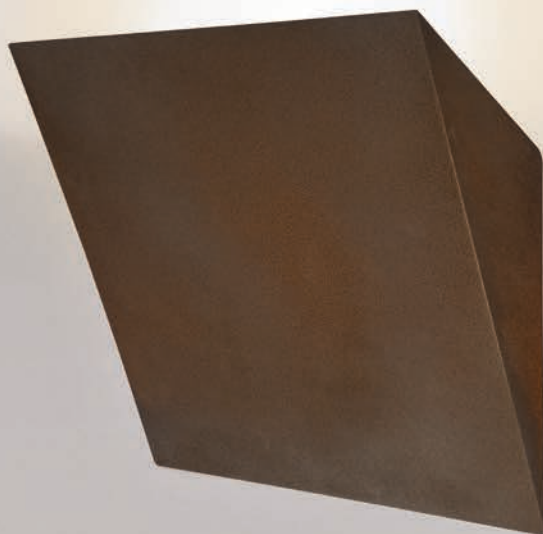

Lampade LED Gypsolyte • LED Gypsolyte lamps



Type	Part N°	Input (V)	Power (W)	Lumen	Light Colour	°Kelvin (±10%)	CRI	Dimensions (mm)	Packing box dimensions (mm)	Weight (kg)
SHARD	<b>BW8432GLEDNW</b>	100÷250 AC	21±1	2850	NW	4000°K	>80	250x125x59h	330x310x135h	2,20
SHARD	<b>BW8432GLEDWW</b>	100÷250 AC	21±1	2600	WW	3000°K	>80	250x125x59h	330x310x135h	2,20
SHARD GOLD	<b>BW8432GOLDNW</b>	100÷250 AC	21±1	2850	NW	4000°K	>80	250x125x59h	330x310x135h	2,20
SHARD GOLD	<b>BW8432GOLDWW</b>	100÷250 AC	21±1	2600	WW	3000°K	>80	250x125x59h	330x310x135h	2,20
SHARD CORTEN	<b>BW8432RUSTNW</b>	100÷250 AC	21±1	2850	NW	4000°K	>80	250x125x59h	330x310x135h	2,20
SHARD CORTEN	<b>BW8432RUSTWW</b>	100÷250 AC	21±1	2600	WW	3000°K	>80	250x125x59h	330x310x135h	2,20

### Applique LED

- Struttura in Gypsolyte
- Grande omogeneità luminosa
- Funziona in bassa tensione con trasformatore incorporato
- Consumo molto limitato
- Lunga durata

### LED wall lamp

- Structure in Gypsolyte
- Homogeneous light output
- Safety low voltage with specific included driver
- Limited consumption
- Long life time

### LED Wandleuchte

- Struktur in Gypsolyte
- Homogenes Licht
- NV-Betrieb durch besonderen Transformator
- Begrenzter Verbrauch
- Lange Lebensdauer

### Applique LED

- Corps en Gypsolyte
- Luminosité très homogène
- Il marche en basse tension avec alimentation intégrée
- Consommation très limitée
- Longue durée de vie

### Lamparas de pared LED

- Estructura de Gypsolyte
- Excelente homogeneidad luminica
- Alta seguridad por funcionamiento a baja tension, con transformador integrado
- Consumo muy limitado- Larga vida

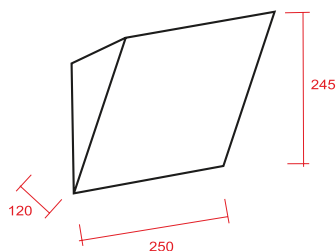



Lampade LED Gypsolyte • LED Gypsolyte lamps



Made in Italy



CE IP20 EMC RoHS

Type	Part N°	Input (V)	Power (W)	Lumen	Light Colour	°Kelvin (±10%)	CRI	Dimensions (mm)	Packing box dimensions (mm)	Weight (kg)
LOGOS	<b>BW8339GLEDNW</b>	100÷250 AC	8±1	940	NW	4000°K	>80	125x125x59h	170x170x110h	1,00
LOGOS	<b>BW8339GLEDWW</b>	100÷250 AC	8±1	890	WW	3000°K	>80	125x125x59h	170x170x110h	1,00
LOGOS GOLD	<b>BW8339GOLDNW</b>	100÷250 AC	8±1	940	NW	4000°K	>80	125x125x59h	170x170x110h	1,00
LOGOS GOLD	<b>BW8339GOLDWW</b>	100÷250 AC	8±1	890	WW	3000°K	>80	125x125x59h	170x170x110h	1,00

### Applique LED

- Struttura in Gypsolyte
- Grande omogeneità luminosa
- Funziona in bassa tensione con trasformatore incorporato
- Consumo molto limitato
- Lunga durata

### LED wall lamp

- Structure in Gypsolyte
- Homogeneous light output
- Safety low voltage with specific included driver
- Limited consumption
- Long life time

### LED Wandleuchte

- Struktur in Gypsolyte
- Homogenes Licht
- NV-Betrieb durch besonderen Transformator
- Begrenzter Verbrauch
- Lange Lebensdauer

### Applique LED

- Corps en Gypsolyte
- Luminosité très homogène
- Il marche en basse tension avec alimentation intégrée
- Consommation très limitée
- Longue durée de vie

### Lamparas de pared LED

- Estructura de Gypsolyte
- Excelente homogeneidad luminica
- Alta seguridad por funcionamiento a baja tension, con transformador integrado
- Consumo muy limitado- Larga vida

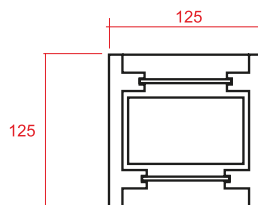
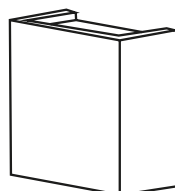

**BOB**

**QUALIKO**  
PROFESSIONAL LIGHT COMPONENTS srl



Lampade LED Gypsolyte • LED Gypsolyte lamps

 Made in Italy



CE IP20 EMC RoHS

Type	Part N°	Input (V)	Power (W)	Lumen	Light Colour	°Kelvin (±10%)	CRI	Dimensions (mm)	Packing box dimensions (mm)	Weight (kg)
BOB	<b>BW8417GLEDWW</b>	100÷250 AC	7±1	350	WW	3000°K	>80	150x125x100h	210x200x180h	1,47
BOB GOLD	<b>BW8417GOLDWW</b>	100÷250 AC	7±1	350	WW	3000°K	>80	150x125x100h	210x200x180h	1,47

 **Applique LED**

- Struttura in Gypsolyte
- Grande omogeneità luminosa
- Funziona in bassa tensione con trasformatore incorporato
- Consumo molto limitato
- Lunga durata

 **LED wall lamp**

- Structure in Gypsolyte
- Homogeneous light output
- Safety low voltage with specific included driver
- Limited consumption
- Long life time

 **LED Wandleuchte**

- Struktur in Gypsolyte
- Homogenes Licht
- NV-Betrieb durch besonderen Transformator
- Begrenzter Verbrauch
- Lange Lebensdauer

 **Applique LED**

- Corps en Gypsolyte
- Luminosité très homogène
- Il marche en basse tension avec alimentation intégrée
- Consommation très limitée
- Longue durée de vie

 **Lamparas de pared LED**

- Estructura de Gypsolyte
- Excelente homogeneidad luminica
- Alta seguridad por funcionamiento a baja tension, con transformador integrado
- Consumo muy limitado- Larga vida

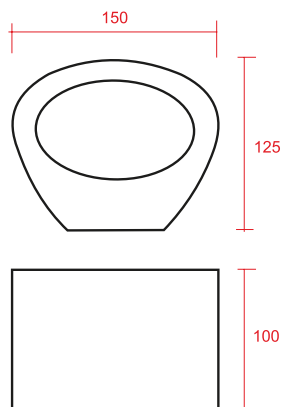

# MOON EVO

QUALIKO  
PROFESSIONAL LIGHT COMPONENTS  
srl



Lampade LED Gypsolyte • LED Gypsolyte lamps



Type	Part N°	Input (V)	Power (W)	Lumen	Light Colour	°Kelvin (±10%)	CRI	Dimensions (mm)	Packing box dimensions (mm)	Weight (kg)
MOON EVO	<b>BW8446GLEDNW</b>	100÷250 AC	11±1	1100	NW	4000°K	>80	Ø260x50h	310x310x95h	2,10
MOON EVO	<b>BW8446GLEDWW</b>	100÷250 AC	11±1	1025	WW	3000°K	>80	Ø260x50h	310x310x95h	2,10
MOON EVO GOLD	<b>BW8446GOLDNW</b>	100÷250 AC	11±1	1100	NW	4000°K	>80	Ø260x50h	310x310x95h	2,10
MOON EVO GOLD	<b>BW8446GOLDWW</b>	100÷250 AC	11±1	1025	WW	3000°K	>80	Ø260x50h	310x310x95h	2,10
MOON EVO CORTEN	<b>BW8446RUSTNW</b>	100÷250 AC	11±1	1100	NW	4000°K	>80	Ø260x50h	310x310x95h	2,10
MOON EVO CORTEN	<b>BW8446RUSTWW</b>	100÷250 AC	11±1	1025	WW	3000°K	>80	Ø260x50h	310x310x95h	2,10

### Applique LED

- Struttura in Gypsolyte
- Grande omogeneità luminosa
- Funziona in bassa tensione con trasformatore incorporato
- Consumo molto limitato
- Lunga durata

### LED wall lamp

- Structure in Gypsolyte
- Homogeneous light output
- Safety low voltage with specific included driver
- Limited consumption
- Long life time

### LED Wandleuchte

- Struktur in Gypsolyte
- Homogenes Licht
- NV-Betrieb durch besonderen Transformator
- Begrenzter Verbrauch
- Lange Lebensdauer

### Applique LED

- Corps en Gypsolyte
- Luminosité très homogène
- Il marche en basse tension avec alimentation intégrée
- Consommation très limitée
- Longue durée de vie

### Lamparas de pared LED

- Estructura de Gypsolyte
- Excelente homogeneidad luminica
- Alta seguridad por funcionamiento a baja tension, con transformador integrado
- Consumo muy limitado- Larga vida

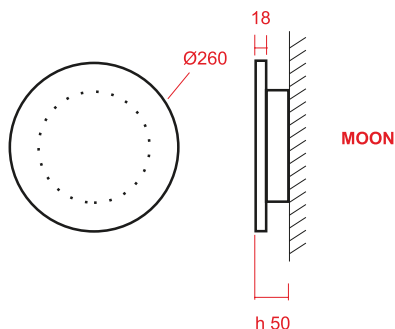

# FLAG EVO

QUALIKO<sup>srl</sup>  
PROFESSIONAL LIGHT COMPONENTS



Lampade LED Gypsolyte • LED Gypsolyte lamps

Made in Italy



CE EMC IP20 RoHS

Type	Part N°	Input (V)	Power (W)	Lumen	Light Colour	°Kelvin (±10%)	CRI	Dimensions (mm)	Packing box dimensions (mm)	Weight (kg)
FLAG EVO	<b>BW8442GLEDNW</b>	100÷250 AC	17±1	1900	NW	4000°K	>80	300x300x50h	360x360x105h	3,00
FLAG EVO	<b>BW8442GLEDWW</b>	100÷250 AC	17±1	1850	WW	3000°K	>80	300x300x50h	360x360x105h	3,00
FLAG EVO GOLD	<b>BW8442GOLDNW</b>	100÷250 AC	17±1	1900	NW	4000°K	>80	300x300x50h	360x360x105h	3,00
FLAG EVO GOLD	<b>BW8442GOLDWW</b>	100÷250 AC	17±1	1850	WW	3000°K	>80	300x300x50h	360x360x105h	3,00
FLAG EVO CORTEN	<b>BW8442RUSTNW</b>	100÷250 AC	17±1	1900	NW	4000°K	>80	300x300x50h	360x360x105h	3,00
FLAG EVO CORTEN	<b>BW8442RUSTWW</b>	100÷250 AC	17±1	1850	WW	3000°K	>80	300x300x50h	360x360x105h	3,00

## Applique LED

- Struttura in Gipsolyte
- Grande omogeneità luminosa
- Funziona in bassa tensione con trasformatore incorporato
- Consumo molto limitato
- Lunga durata

## LED wall lamp

- Structure in Gipsolyte
- Homogeneous light output
- Safety low voltage with specific included driver
- Limited consumption
- Long life time

## LED Wandleuchte

- Struktur in Gipsolyte
- Homogenes Licht
- NV-Betrieb durch besonderen Transformator
- Begrenzter Verbrauch
- Lange Lebensdauer

## Applique LED

- Corps en Gipsolyte
- Luminosité très homogène
- Il marche en basse tension avec alimentation intégrée
- Consommation très limitée
- Longue durée de vie

## Lamparas de pared LED

- Estructura de Gipsolyte
- Excelente homogeneidad luminica
- Alta seguridad por funcionamiento a baja tension, con transformador integrado
- Consumo muy limitado- Larga vida

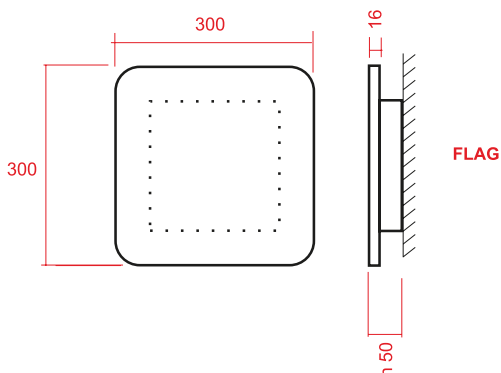

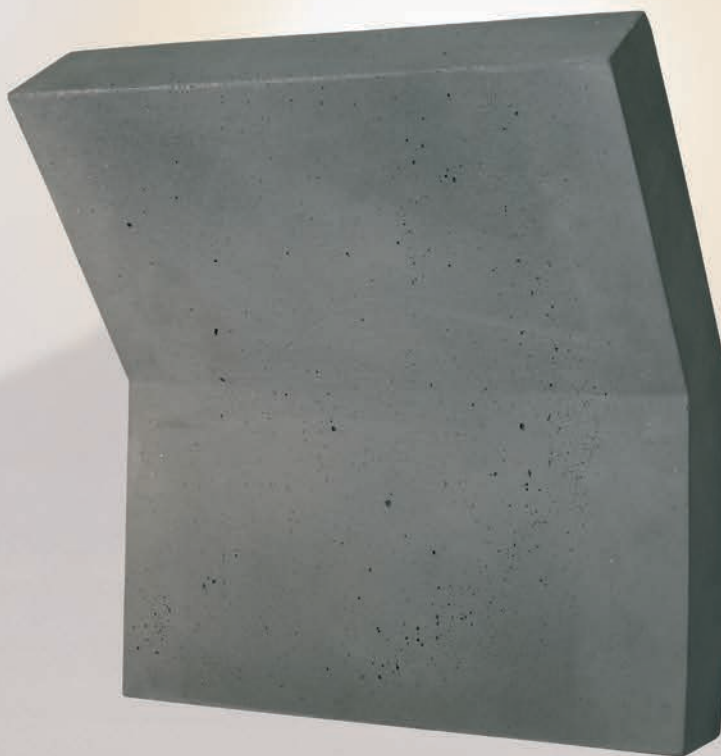

Lampade LED Cemento • LED Concrete lamps



Made in Italy

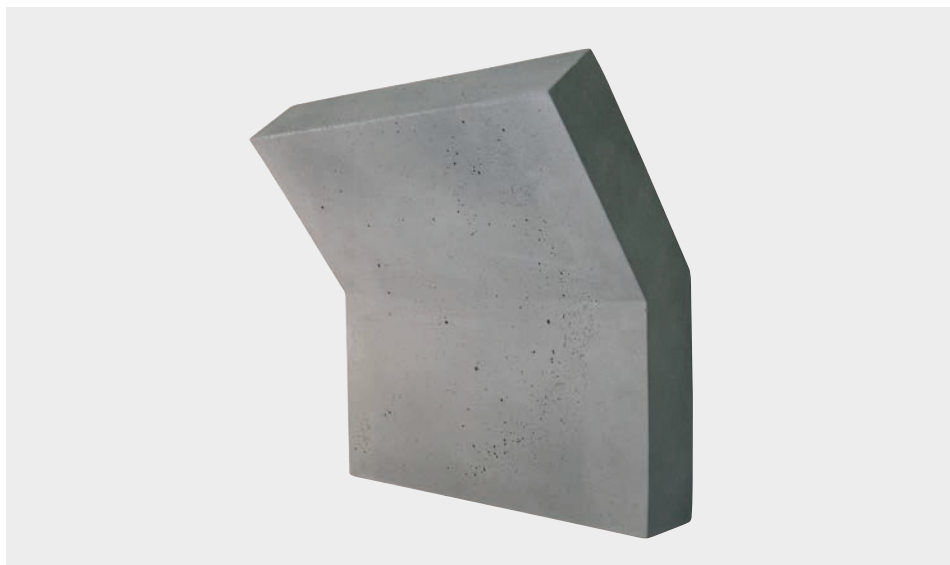

CE IP54 EMC RoHS

Type	Part N°	Input (V)	Power (W)	Lumen	Light Colour	°Kelvin (±10%)	CRI	Dimensions (mm)	Packing box dimensions (mm)	Weight (kg)
FOLD LARGE	<b>BWC8422LEDNW</b>	100÷250 AC	31±1	3800	NW	4000°K	>80	135x300x300h	380x370x160h	3,00
FOLD LARGE	<b>BWC8422LEDWW</b>	100÷250 AC	31±1	3650	WW	3000°K	>80	135x300x300h	380x370x160h	3,00

## Applique LED

- Struttura in Cemento
- Grande omogeneità luminosa
- Funziona in bassa tensione con trasformatore incorporato
- Consumo molto limitato
- Lunga durata

## LED wall lamp

- Structure in Concrete
- Homogeneous light output
- Safety low voltage with specific included driver
- Limited consumption
- Long life time

## LED Wandleuchte

- Struktur in Beton
- Homogenes Licht
- NV-Betrieb durch besonderen Transformator
- Begrenzter Verbrauch
- Lange Lebensdauer

## Applique LED

- Corps en Ciment
- Luminosité très homogène
- Il marche en basse tension avec alimentation intégrée
- Consommation très limitée
- Longue durée de vie

## Lamparas de pared LED

- Estructura de Cemento
- Excelente homogeneidad luminica
- Alta seguridad por funcionamiento a baja tension, con transformador integrado
- Consumo muy limitado- Larga vida

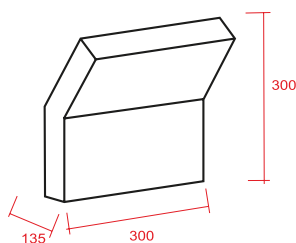



Lampade LED Cemento • LED Concrete lamps

 Made in Italy



CE IP54 EMC RoHS

Type	Part N°	Input (V)	Power (W)	Lumen	Light Colour	°Kelvin (±10%)	CRI	Dimensions (mm)	Packing box dimensions (mm)	Weight (kg)
FRAME SQ	<b>BWC8438LEDNW</b>	100÷250 AC	8±1	930	NW	4000°K	>80	222x150x50h	265x210x110h	1,30
FRAME SQ	<b>BWC8438LEDWW</b>	100÷250 AC	8±1	890	WW	3000°K	>80	222x150x50h	265x210x110h	1,30

## Applique LED

- Struttura in Cemento
- Grande omogeneità luminosa
- Funziona in bassa tensione con trasformatore incorporato
- Consumo molto limitato
- Lunga durata

## LED wall lamp

- Structure in Concrete
- Homogeneous light output
- Safety low voltage with specific included driver
- limited consumption
- long life time

## LED Wandleuchte

- Struktur in Beton
- Homogenes Licht
- NV-Betrieb durch besonderen Transformator
- Begrenzter Verbrauch
- Lange Lebensdauer

## Applique LED

- Corps en Ciment
- Luminosité très homogène
- Il marche en basse tension avec alimentation intégrée
- Consommation tres limitée
- Longue durée de vie

## Lamparas de pared LED

- Estructura de Cemento
- Excelente homogeneidad luminica
- Alta seguridad por funcionamiento a baja tension, con transformador integrado
- Consumo muy limitado
- Larga vida

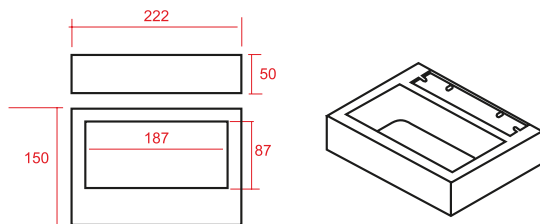



Lampade LED Cemento • LED Concrete lamps

 Made in Italy



CE IP54 EMC RoHS

Type	Part N°	Input (V)	Power (W)	Lumen	Light Colour	°Kelvin (±10%)	CRI	Dimensions (mm)	Packing box dimensions (mm)	Weight (kg)
BRICK	<b>BWC8211LEDNW</b>	100÷250 AC	12±1	1310	NW	4000°K	>80	275x94x57h	340x150x120h	1,30
BRICK	<b>BWC8211LEDWW</b>	100÷250 AC	12±1	1250	WW	3000°K	>80	275x94x57h	340x150x120h	1,30

 **Applique LED**

- Struttura in Cemento
- Grande omogeneità luminosa
- Funziona in bassa tensione con trasformatore incorporato
- Consumo molto limitato
- Lunga durata

 **LED wall lamp**

- Structure in Concrete
- Homogeneous light output
- Safety low voltage with specific included driver
- Limited consumption
- Long life time

 **LED Wandleuchte**

- Struktur in Beton
- Homogenes Licht
- NV-Betrieb durch besonderen Transformator
- Begrenzter Verbrauch
- Lange Lebensdauer

 **Applique LED**

- Corps en Ciment
- Luminosité très homogène
- Il marche en basse tension avec alimentation intégrée
- Consommation très limitée
- Longue durée de vie

 **Lamparas de pared LED**

- Estructura de Cemento
- Excelente homogeneidad luminica
- Alta seguridad por funcionamiento a baja tension, con transformador integrado
- Consumo muy limitado- Larga vida

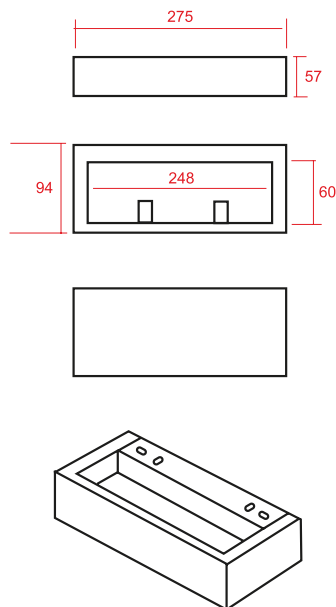



Lampade LED Cemento • LED Concrete lamps

 Made in Italy



CE IP54 EMC RoHS

Type	Part N°	Input (V)	Power (W)	Lumen	Light Colour	°Kelvin (±10%)	CRI	Dimensions (mm)	Packing box dimensions (mm)	Weight (kg)
LOGOS	<b>BWC8339LEDNW</b>	100÷250 AC	8±1	940	NW	4000°K	>80	125x125x59h	170x170x110h	1,00
LOGOS	<b>BWC8339LEDWW</b>	100÷250 AC	8±1	890	WW	3000°K	>80	125x125x59h	170x170x110h	1,00

### Applique LED

- Struttura in Cemento
- Grande omogeneità luminosa
- Funziona in bassa tensione con trasformatore incorporato
- Consumo molto limitato
- Lunga durata

### LED wall lamp

- Structure in Concrete
- Homogeneous light output
- Safety low voltage with specific included driver
- Limited consumption
- Long life time

### LED Wandleuchte

- Struktur in Beton
- Homogenes Licht
- NV-Betrieb durch besonderen Transformator
- Begrenzter Verbrauch
- Lange Lebensdauer

### Applique LED

- Corps en Ciment
- Luminosité très homogène
- Il marche en basse tension avec alimentation intégrée
- Consommation très limitée
- Longue durée de vie

### Lamparas de pared LED

- Estructura de Cemento
- Excelente homogeneidad luminica
- Alta seguridad por funcionamiento a baja tension, con transformador integrado
- Consumo muy limitado- Larga vida

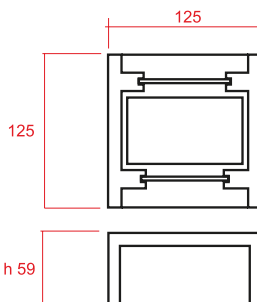
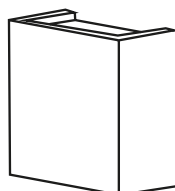

**BOB**

**QUALIKO**  
PROFESSIONAL LIGHT COMPONENTS srl



Lampade LED Cemento • LED Concrete lamps



 Made in Italy



CE IP54 EMC RoHS

Type	Part N°	Input (V)	Power (W)	Lumen	Light Colour	°Kelvin (±10%)	CRI	Dimensions (mm)	Packing box dimensions (mm)	Weight (kg)
BOB	<b>BWC8417LEDWW</b>	100±250 AC	7±1	350	WW	3000°K	>80	150x125x100h	210x200x180h	1,47

 **Applique LED**

- Struttura in Cemento
- Grande omogeneità luminosa
- Funziona in bassa tensione con trasformatore incorporato
- Consumo molto limitato
- Lunga durata

 **LED wall lamp**

- Structure in Concrete
- Homogeneous light output
- Safety low voltage with specific included driver
- Limited consumption
- Long life time

 **LED Wandleuchte**

- Struktur in Beton
- Homogenes Licht
- NV-Betrieb durch besonderen Transformator
- Begrenzter Verbrauch
- Lange Lebensdauer

 **Applique LED**

- Corps en Ciment
- Luminosité très homogène
- Il marche en basse tension avec alimentation intégrée
- Consommation très limitée
- Longue durée de vie

 **Lamparas de pared LED**

- Estructura de Cemento
- Excelente homogeneidad luminica
- Alta seguridad por funcionamiento a baja tension, con transformador integrado
- Consumo muy limitado- Larga vida

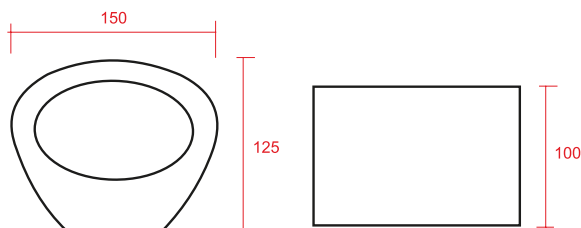

# LED outdoor wall lamps

QUALIKO<sup>srl</sup>  
PROFESSIONAL LIGHT COMPONENTS

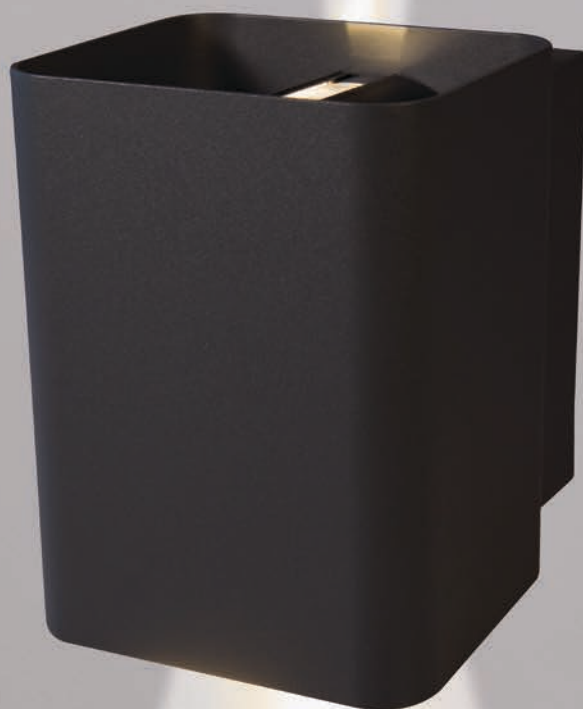

Appliques LED da esterno • LED outdoor wall lamps



**IK06**  **IP54** EMC RoHS

Type	Part N°	Input (V)	Power (W)	Angolo Beam	Lumen	Light Colour	°Kelvin (±10%)	CRI	Dimensions (mm)	Packing box dimensions (mm)	Weight (kg)
MOXY ONE	<b>BWE20711Q30D</b>	100÷240V AC	12±1	44°	846	WW	3000°K	>80	132x100x138h	370x150x140h	1,20

 **Applique LED**

- Struttura in alluminio – Colore antracite
- Emissione luminosa su di un lato
- Temperatura di esercizio -20°C÷+40°C
- Consumo molto limitato
- Lunga durata

 **LED wall light**

- Aluminum structure - Anthracite color
- Light emission on one side
- Operating temperature -20°C÷+40°C
- Very limited consumption
- Long duration

 **LED Wandleuchte**

- Aluminiumstruktur - Farbe Anthrazit
- Lichtausstrahlung einseitig
- Betriebstemperatur -20°C÷+40°C
- Sehr begrenzter Verbrauch
- Lange Dauer

 **Applique LED**

- Corps en aluminium – Couleur
- Émission de lumière d'un côté anthracite
- Température de fonctionnement -20°C÷+40°C
- Faible consommation
- Durée de vie élevée

 **Luz de pared LED**

- Estructura de aluminio - Color antracita
- Emisión de luz en un lado
- Temperatura de funcionamiento -20°C÷+40°C
- Consumo muy limitado
- Larga duración





**IK06** **CE** **IP54** **EMC** **RoHS**

Type	Part N°	Input (V)	Power (W)	Angolo Beam	Lumen	Light Colour	°Kelvin (±10%)	CRI	Dimensions (mm)	Packing box dimensions (mm)	Weight (kg)
MOXY TWO	<b>BWE20722Q30D</b>	100÷240V AC	2x12±1	44°	1577	WW	3000°K	>80	132x100x220h	140x115x245h	1,62

- 🇮🇹 Applique LED**
- Struttura in alluminio – Colore antracite
  - Emissione luminosa su due lati
  - Temperatura di esercizio -20°C÷+40°C
  - Consumo molto limitato
  - Lunga durata

- 🇬🇧 LED wall light**
- Aluminum structure - Anthracite color
  - Light emission on two sides
  - Operating temperature -20°C÷+40°C
  - Very limited consumption
  - Long duration

- 🇩🇪 LED Wandleuchte**
- Aluminiumstruktur - Farbe Anthrazit
  - Lichtausstrahlung auf zwei Seiten
  - Betriebstemperatur -20°C÷+40°C
  - Sehr begrenzter Verbrauch
  - Lange Dauer

- 🇫🇷 Applique LED**
- Corps en aluminium – Couleur
  - Émission de lumière sur deux côtés
  - Température de fonctionnement -20°C÷+40°C
  - Faible consommation
  - Durée de vie élevée

- 🇪🇸 Luz de pared LED**
- Estructura de aluminio - Color antracita
  - Emisión de luz en ambos lados
  - Temperatura de funcionamiento -20°C÷+40°C
  - Consumo muy limitado
  - Larga duración

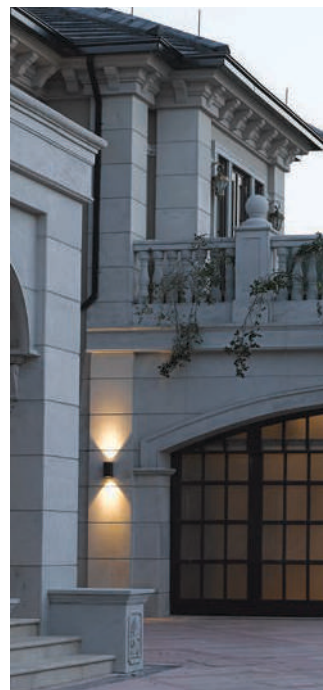



IK06 CE IP54 EMC RoHS

Type	Part N°	Input (V)	Power (W)	Angolo Beam	Lumen	Light Colour	°Kelvin (±10%)	CRI	Dimensions (mm)	Packing box dimensions (mm)	Weight (kg)
BLADE	<b>BWE19612Q30D</b>	100÷240V AC	2X6±1	0°÷85°	806	WW	3000°K	>80	104x129x138h	165x160x162h	0,97

 **Applique LED**

- Struttura in alluminio – Colore antracite
- Emissione luminosa su due lati regolabili 0° ÷ 85°
- Temperatura di esercizio -20°C÷+40°C
- Consumo molto limitato
- Lunga durata

 **LED wall light**

- Aluminum structure - Anthracite color
- Light emission on two sides adjustable 0° ÷ 85°
- Operating temperature -20°C÷+40°C
- Very limited consumption
- Long duration

 **LED Wandleuchte**

- Aluminiumstruktur - Farbe Anthrazit
- Lichtausstrahlung zweiseitig einstellbar 0° ÷ 85°
- Betriebstemperatur -20°C÷+40°C
- Sehr begrenzter Verbrauch
- Lange Dauer

 **Applique LED**

- Corps en aluminium – Couleur
- Émission de lumière sur deux côtés réglables 0° ÷ 85°
- Température de fonctionnement -20°C÷+40°C
- Faible consommation
- Durée de vie élevée

 **Luz de pared LED**

- Estructura de aluminio - Color antracita
- Emisión de luz en dos lados ajustable 0° ÷ 85°
- Temperatura de funcionamiento -20°C÷+40°C
- Consumo muy limitado
- Larga duración





**IK06**  **IP54** **EMC** **RoHS**

Type	Part N°	Input (V)	Power (W)	Angolo Beam	Lumen	Light Colour	°Kelvin (±10%)	CRI	Dimensions (mm)	Packing box dimensions (mm)	Weight (kg)
RAZOR	<b>BWE2562BQ30D</b>	100÷240V AC	2x3±1	40°-80°	130	WW	3000°K	>80	71x74x92h	95x80x110h	0,49

 **Applique LED**

- Struttura in alluminio - Colore antracite
- Emissione luminosa su due lati non regolabili
- Temperatura di esercizio -20°C÷+40°C
- Consumo molto limitato
- Lunga durata

 **LED wall light**

- Aluminum structure - Anthracite color
- Light emission on two non-adjustable sides
- Operating temperature -20 ° C ÷ + 40 ° C
- Very limited consumption
- Long duration

 **LED Wandleuchte**

- Aluminiumstruktur - Farbe Anthrazit
- Lichtausstrahlung zweiseitig nicht einstellbar
- Betriebstemperatur -20 ° C ÷ + 40 ° C
- Sehr begrenzter Verbrauch
- Lange Dauer

 **Applique LED**

- Corps en aluminium – Couleur
- Émission de lumière sur deux côtés non réglables
- Température de fonctionnement -20°C÷+40°C
- Faible consommation
- Durée de vie élevée

 **Luz de pared LED**

- Estructura de aluminio - Color antracita
- Emisión de luz en dos lados no ajustables
- Temperatura de funcionamiento -20 ° C ÷ + 40 ° C
- Consumo muy limitado
- Larga duración





**IK06**  **IP65** EMC RoHS

Type	Part N°	Input (V)	Power (W)	Angolo Beam	Lumen	Light Colour	°Kelvin (±10%)	CRI	Dimensions (mm)	Packing box dimensions (mm)	Weight (kg)
GLOW	<b>BWE2724R030D</b>	100÷240V AC	4,5±1	77°	218	WW	3000°K	>80	87x35x135h	94x43x145h	0,29

 **Segnapasso LED**

- Struttura in alluminio - Colore antracite
- Si fissa direttamente al muro senza cassaforma
- Temperatura di esercizio -20°C÷+40°C
- Consumo molto limitato
- Lunga durata

 **LED marker**

- Aluminum structure - Anthracite color
- It is fixed directly to the wall without formwork
- Operating temperature -20°C÷+40°C
- Very limited consumption
- Long duration

 **LED-Markierung**

- Aluminiumstruktur - Farbe Anthrazit
- Es wird ohne Schalung direkt an der Wand befestigt
- Betriebstemperatur -20°C÷+40°C
- Sehr begrenzter Verbrauch
- Lange Dauer

 **Marqueur à LED**

- Corps en aluminium - Couleur
- Fixation directe au mur sans boîte d'encastrement
- Température de fonctionnement -20°C÷+40°C
- Faible consommation
- Durée de vie élevée

 **Marcador LED**

- Estructura de aluminio - Color antracita
- Se fija directamente a la pared sin encofrado
- Temperatura de funcionamiento -20°C÷+40°C
- Consumo muy limitado
- Larga duración





Incassi Gypsolyte • Gypsolyte fixtures





Type	Part n°	Dimensions mm	Standard	Colour	mm	Packing box dimensions (mm)	Packing box (kg)
ARAGON Q1B	<b>B9129G050Q1B</b>	120x120x55h	MR16	White	125x125	170x170x110	0,64

Vedere pagina 168 per i kit che includono la lampadina LED - See page 168 for kits including LED lamp

**Incasso in Gypsolyte per controsoffitti (per moduli LED)**

- Incasso invisibile per controsoffitti
- Dopo aver rasato a gesso il controsoffitto, l'incasso risulta parte integrante del soffitto stesso e può essere tinteggiato
- Apertura per installazione 125x125 mm.
- Adatto a moduli LED standard MR16

**Gypsolyte fitting for counter ceiling (for LED modules)**

- Invisible fitting for counter ceilings
- Once the counter ceiling is finished with smoothing plaster, the fitting is almost invisible and can be painted together with the ceiling
- Installation hole mm 125x125
- Suitable for standard MR16 LED modules

**Einbaustrahler aus Gypsolyte für Unterdecken (für Led-Modulen geeignet)**

- Unsichtbare Einbaustrahler für Unterdecken
- Sobald die Unterdecke durch Gips glatt gemacht ist, wird der Einbaustrahler fast unsichtbar und kann zusammen mit der Unterdecke gemalt werden
- Montageöffnung 125x125 mm.
- Für Standard MR16 LED-Module geeignet

**Encastrable en Gypsolyte pour plafond (pour modules à LED)**

- Encastrable invisible pour faux plafond
- Après avoir lissé le faux-plafond, le boîtier encastrable devient partie intégrante du faux-plafond lui même et peut être peint
- Ouverture dans le plafond pour l'installation: 125x125 mm.
- Adapté aux modules LED MR16 standard

**Cazoleta para falso techo (para módulos de LED) in Gypsolyte**

- Cazoleta para falso techo Gypsolyte (para módulos de LED)
- Cazoleta invisible para falsos techos
- Una vez terminado el falso techo con yeso la carcasa es casi invisible y puede ser pintado junto con el techo
- Medidas del orificio para la instalación: 125x125 mm.
- Apropiado para módulos estándar de LED MR16

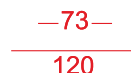
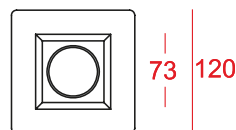
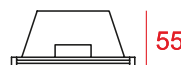

# ARAGON XL

QUALIKO<sup>srl</sup>  
PROFESSIONAL LIGHT COMPONENTS



Incassi Gypsolyte • Gypsolyte fixtures

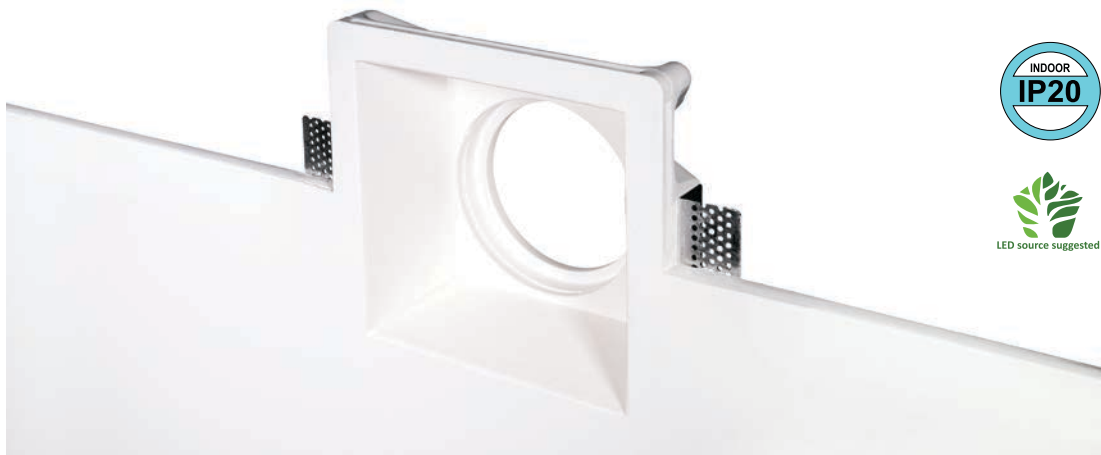

Type	Part n°	Dimensions mm	Standard	Colour	mm	Packing box dimensions (mm)	Packing box (kg)
ARAGON XL Q1B	<b>B9247G111Q1B</b>	200x200x75h	AR111	White	203x203	250x270x130	1,80

Vedere pagina 168 per i kit che includono la lampadina LED e il driver - See page 168 for kits including LED lamp and driver

### Incasso in Gypsolyte per controsoffitti (per moduli LED)

- Incasso invisibile per controsoffitti
- Dopo aver rasato a gesso il controsoffitto, l'incasso risulta parte integrante del soffitto stesso e può essere tinteggiato
- Apertura per installazione 203x203 mm.
- Adatto a moduli LED standard AR111

### Gypsolyte fitting for counter ceiling (for LED modules)

- Invisible fitting for counter ceiling
- Once the counter ceiling is finished with smoothing plaster, the fitting is almost invisible and can be painted together with the ceiling
- Installation hole mm 203x203
- Suitable for standard AR111 LED modules

### Einbaustrahler aus Gypsolyte für Unterdecken (für Led-Modulen geeignet)

- Unsichtbare Einbaustrahler für Unterdecken
- Sobald die Unterdecke durch Gips glatt gemacht ist, wird der Einbaustrahler fast unsichtbar und kann zusammen mit der Unterdecke gemalt werden
- Montageöffnung 203x203mm.
- Für Standard AR111 LED-Module geeignet

### Encastrable en Gypsolyte pour plafond (pour modules à LED)

- Encastrable invisible pour faux plafond
- Après avoir lissé le faux-plafond, le boîtier encastrable devient partie intégrante du faux-plafond lui même et peut être peint
- Ouverture dans le plafond pour l'installation: 203x203 mm.
- Adapté aux modules led AR111 standard

### Cazoleta para falso techo (para módulos de LED) in Gypsolyte

- Cazoleta para falso techo Gypsolyte (para módulos de led)
- Cazoleta invisible para falsos techos
- Una vez terminado el falso techo con yeso la carcasa es casi invisible y puede ser pintado junto con el techo
- Medidas del orificio para la instalación 203x203 mm

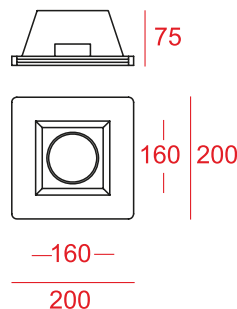

Optional driver 12V AC 30W  
A10MT0300008

Optional 12V AC-DC LED bulb AR111:  
A440QL11130M2 (13W - 3000K)  
A440QL11140M2 (13W - 4000K)



# ARAGON GLASS

QUALIKO<sup>srl</sup>  
PROFESSIONAL LIGHT COMPONENTS



Incassi Gypsolyte • Gypsolyte fixtures



Type	Part n°	Dimensions mm	Standard	Colour	 mm	Packing box dimensions (mm)	Packing box (kg)
ARAGON GLASS	<b>B9128GV50Q1B</b>	120x120x55h	MR16	White	125x125	170x170x110	0,64

Vedere pagina 168 per i kit che includono la lampadina LED - See page 168 for kits including LED lamp

### Incasso in Gypsolyte per controsoffitti (per moduli LED)

- L'aggiunta di un vetro satinato permette di eliminare l'abbagliamento della fonte di luce
- Incasso invisibile per controsoffitti
- Dopo aver rasato a gesso il controsoffitto, l'incasso risulta parte integrante del soffitto stesso e può essere tinteggiato
- Apertura per installazione 125x125 mm.
- Adatto a moduli LED standard MR16

### Gypsolyte fitting for counter ceiling (for LED modules)

- A frosted glass avoids dazzle
- Invisible fitting for counter ceilings
- Once the counter ceiling is finished with smoothing plaster, the fitting is almost invisible and can be painted together with the ceiling
- Installation hole mm 125x125
- Suitable for standard MR16 LED modules

### Einbaustrahler aus Gypsolyte für Unterdecken (für Led-Modulen geeignet)

- Der Zusatz einer Milchglas macht es möglich, den Schein der Lichtquelle zu beseitigen
- Unsichtbare Einbaustrahler für Unterdecken
- Sobald die Unterdecke durch Gips glatt gemacht ist, wird der Einbaustrahler fast unsichtbar und kann zusammen mit der Unterdecke gemalt werden
- Montageöffnung 125x125 mm.
- Für Standard MR16 LED-Module geeignet

### Encastrable en Gypsolyte pour plafond (pour modules à LED)

- L'ajout d'une vitre satinée permet d'éliminer l'éblouissement dû à la source de lumière
- Encastrable invisible pour faux plafond
- Après avoir lissé le faux-plafond, le boîtier encastrable devient partie intégrante du faux-plafond lui même et peut être peint
- Ouverture dans le plafond pour l'installation: 125x125 mm.
- Adapté aux modules LED MR16 standard

### Cazoleta para falso techo (para módulos de LED) in Gypsolyte

- Un cristal esmerilado evita los deslumbramientos
- Cazoleta para falso techo Gypsolyte (para módulos de LED)
- Cazoleta invisible para falsos techos
- Una vez terminado el falso techo con yeso la carcasa es casi invisible y puede ser pintado junto con el techo
- Medidas del orificio para la instalación 125x125 mm.
- Apropiado para módulos estándar de LED MR16

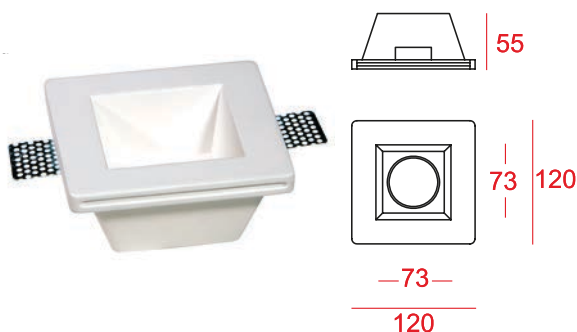

# ARAGON FLAT

QUALIKO<sup>srl</sup>  
PROFESSIONAL LIGHT COMPONENTS



Incassi Gypsolyte • Gypsolyte fixtures



Type	Part n°	Dimensions mm	Standard	Colour	 mm	Packing box dimensions (mm)	Packing box (kg)
ARAGON FLAT Q1B	<b>B9222G050Q1B</b>	100x100x27h	MR16	White	105x105	150x150x80	0,40

Vedere pagina 168 per i kit che includono la lampadina LED - See page 168 for kits including LED lamp

### Incasso in Gypsolyte per controsoffitti (per moduli LED)

- Incasso invisibile per controsoffitti
- Dopo aver rasato a gesso il controsoffitto, l'incasso risulta parte integrante del soffitto stesso e può essere tinteggiato
- Apertura per installazione 105x105 mm.
- Adatto a moduli LED standard MR16

### Gypsolyte fitting for counter ceiling (for LED modules)

- Invisible fitting for counter ceilings
- Once the counter ceiling is finished with smoothing plaster, the fitting is almost invisible and can be painted together with the ceiling
- Installation hole mm 105x105
- Suitable for standard MR16 LED modules

### Einbaustrahler aus Gypsolyte für Unterdecken (für Led-Modulen geeignet)

- Unsichtbare Einbaustrahler für Unterdecken
- Sobald die Unterdecke durch Gips glatt gemacht ist, wird der Einbaustrahler fast unsichtbar und kann zusammen mit der Unterdecke gemalt werden
- Montageöffnung 105x105 mm.
- Für Standard MR16 LED-Module geeignet

### Encastrable en Gypsolyte pour plafond (pour modules à LED)

- Encastrable invisible pour faux plafond
- Après avoir lissé le faux-plafond, le boîtier encastrable devient partie intégrante du faux-plafond lui même et peut être peint
- Ouverture dans le plafond pour l'installation: 105x105 mm.
- Adapté aux modules LED MR16 standard

### Cazoleta para falso techo (para módulos de LED) in Gypsolyte

- Cazoleta para falso techo Gypsolyte (para módulos de LED)
- Cazoleta invisible para falsos techos
- Una vez terminado el falso techo con yeso la carcasa es casi invisible y puede ser pintado junto con el techo
- Medidas del orificio para la instalación 105x105 mm.
- Apropriado para módulos estándar de LED MR16

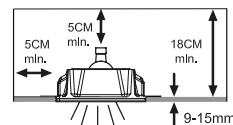
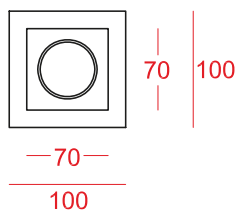

# ARAGON TWIN

QUALIKO<sup>srl</sup>  
PROFESSIONAL LIGHT COMPONENTS



Incassi Gypsolyte • Gypsolyte fixtures





Type	Part n°	Dimensions mm	Standard	Colour	 mm	Packing box dimensions (mm)	Packing box (kg)
ARAGON TWIN Q2B	<b>B9223G050Q2B</b>	215x120x55h	2x MR16	White	200x125	260x165x110	1,10

Vedere pagina 168 per i kit che includono la lampadina LED - See page 168 for kits including LED lamp

### Incasso in Gypsolyte per controsoffitti (per moduli LED)

- Incasso invisibile per controsoffitti
- Dopo aver rasato a gesso il controsoffitto, l'incasso risulta parte integrante del soffitto stesso e può essere tinteggiato
- Apertura per installazione 220x125 mm.
- Adatto a moduli LED standard MR16

### Gypsolyte fitting for counter ceiling (for LED modules)

- Invisible fitting for counter ceilings
- Once the counter ceiling is finished with smoothing plaster, the fitting is almost invisible and can be painted together with the ceiling
- Installation hole mm 220x125
- Suitable for standard MR16 LED modules

### Einbaustrahler aus Gypsolyte für Unterdecken (für Led-Modulen geeignet)

- Unsichtbare Einbaustrahler für Unterdecken
- Sobald die Unterdecke durch Gips glatt gemacht ist, wird der Einbaustrahler fast unsichtbar und kann zusammen mit der Unterdecke gemalt werden
- Montageöffnung 220x125 mm.
- Für Standard MR16 LED-Module geeignet

### Encastrable en Gypsolyte pour plafond (pour modules à LED)

- Encastrable invisible pour faux plafond
- Après avoir lissé le faux-plafond, le boîtier encastrable devient partie intégrante du faux-plafond lui même et peut être peint
- Ouverture dans le plafond pour l'installation: 220x125 mm.
- Adapté aux modules LED MR16 standard

### Cazoleta para falso techo (para módulos de LED) in Gypsolyte

- Cazoleta para falso techo Gypsolyte (para módulos de LED)
- Cazoleta invisible para falsos techos
- Una vez terminado el falso techo con yeso la carcasa es casi invisible y puede ser pintado junto con el techo
- Medidas del orificio para la instalación 220x125 mm.
- Apropiado para módulos estándar de LED MR16

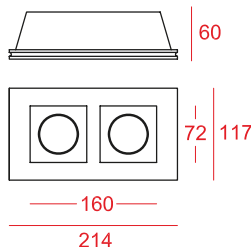



Incassi Gypsolyte • Gypsolyte fixtures

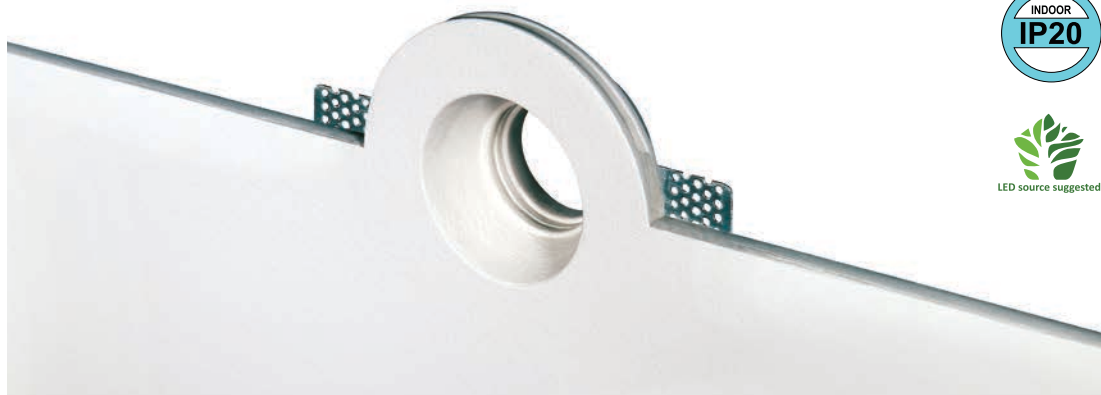

Type	Part n°	Dimensions mm	Standard	Colour	 mm	Packing box dimensions (mm)	Packing box (kg)
OBLÒ T1B	B9130G050T1B	Ø130x45h	MR16	White	Ø135	170x170x110	0,57

Vedere pagina 168 per i kit che includono la lampadina LED - See page 168 for kits including LED lamp

**Incasso in Gypsolyte per controsoffitti (per moduli LED)**

- Incasso invisibile per controsoffitti
- Dopo aver rasato a gesso il controsoffitto, l'incasso risulta parte integrante del soffitto stesso e può essere tinteggiato
- Apertura per installazione Ø135 mm.
- Adatto a moduli LED standard MR16

**Gypsolyte fitting for counter ceiling (for LED modules)**

- Invisible fitting for counter ceilings
- Once the counter ceiling is finished with smoothing plaster, the fitting is almost invisible and can be painted together with the ceiling
- Installation hole mm Ø135
- Suitable for standard MR16 LED modules

**Einbaustrahler aus Gypsolyte für Unterdecken (für Led-Modulen geeignet)**

- Unsichtbare Einbaustrahler für Unterdecken
- Sobald die Unterdecke durch Gips glatt gemacht ist, wird der Einbaustrahler fast unsichtbar und kann zusammen mit der Unterdecke gemalt werden
- Montageöffnung Ø135 mm.
- Für Standard MR16 LED-Module geeignet

**Encastrable en Gypsolyte pour plafond (pour modules à LED)**

- Encastrable invisible pour faux plafond
- Après avoir lissé le faux-plafond, le boîtier encastrable devient partie intégrante du faux-plafond lui même et peut être peint
- Ouverture dans le plafond pour l'installation: Ø135 mm.
- Adapté aux modules LED MR16 standard

**Cazoleta para falso techo (para módulos de LED) in Gypsolyte**

- Cazoleta para falso techo Gypsolyte (para módulos de LED)
- Cazoleta invisible para falsos techos
- Una vez terminado el falso techo con yeso la carcasa es casi invisible y puede ser pintado junto con el techo
- Medidas del orificio para la instalación Ø135 mm.
- Apropriado para módulos estándar de LED MR16

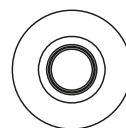



- Ø73 -  
Ø130



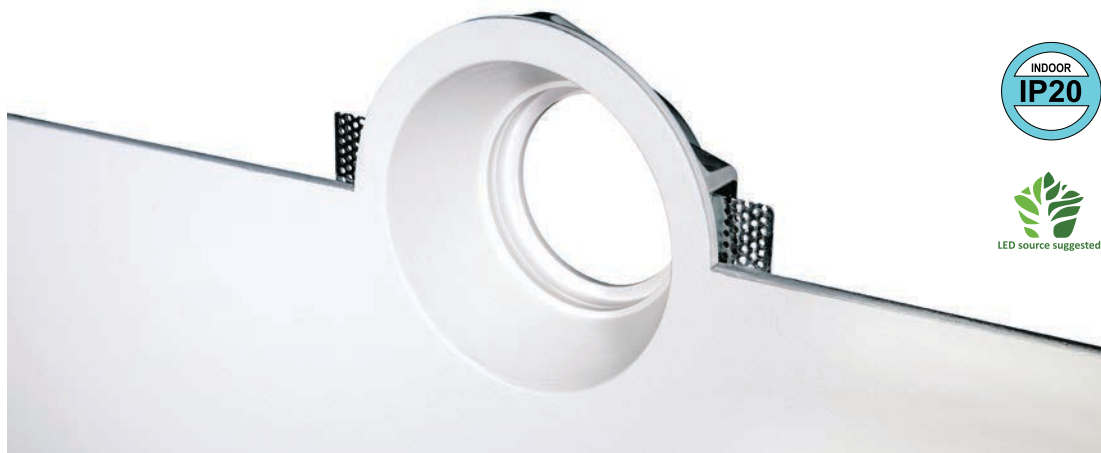

Incassi Gypsolyte • Gypsolyte fixtures



Type	Part n°	Dimensions mm	Standard	Colour	 mm	Packing box dimensions (mm)	Packing box (kg)
OBLÒ XL T1B	<b>B9248G111T1B</b>	Ø200x75h	AR111	White	Ø205	250x270x130	1,40

Vedere pagina 168 per i kit che includono la lampadina LED e il driver - See page 168 for kits including LED lamp and driver

### **Incasso in Gypsolyte per controsoffitti (per moduli LED)**

- Incasso invisibile per controsoffitti
- Dopo aver rasato a gesso il controsoffitto, l'incasso risulta parte integrante del soffitto stesso e può essere tinteggiato
- Apertura per installazione Ø 205 mm.
- Adatto a moduli LED standard AR111

### **Gypsolyte fitting for counter ceiling (for LED modules)**

- Invisible fitting for counter ceilings
- Once the counter ceiling is finished with smoothing plaster, the fitting is almost invisible and can be painted together with the ceiling
- Installation hole mm Ø 205 mm.
- Suitable for standard AR111 LED modules

### **Einbaustrahler aus Gypsolyte für Unterdecken (für Led-Modulen geeignet)**

- Unsichtbare Einbaustrahler für Unterdecken
- Sobald die Unterdecke durch Gips glatt gemacht ist, wird der Einbaustrahler fast unsichtbar und kann zusammen mit der Unterdecke gemalt werden
- Montageöffnung Ø 205 mm.
- Für Standard AR111 LED-Module geeignet

### **Encastrable en Gypsolyte pour plafond (pour modules à LED)**

- Encastrable invisible pour faux plafond
- Après avoir lissé le faux-plafond, le boîtier encastrable devient partie intégrante du faux-plafond lui même et peut être peint
- Ouverture dans le plafond pour l'installation: Ø205 mm.
- Adapté aux modules led AR111 standard.

### **Cazoleta para falso techo (para módulos de LED) in Gypsolyte**

- Cazoleta para falso techo Gypsolyte (para módulos de led)
- Cazoleta invisible para falsos techos
- Una vez terminado el falso techo con yeso la carcasa es casi invisible y puede ser pintado junto con el techo
- Medidas del orificio para la instalación Ø 205 mm.
- Apropriadado para módulos estándar de led AR111.

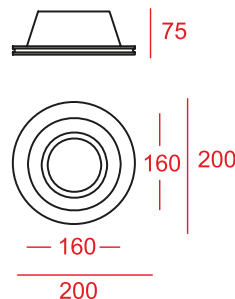

Optional driver 12V AC 30W  
A10MT0300008

Optional 12V AC-DC LED bulb AR111:  
A440QL11130M2 (13W - 3000K)  
A440QL11140M2 (13W - 4000K)





Incassi Gypsolyte • Gypsolyte fixtures

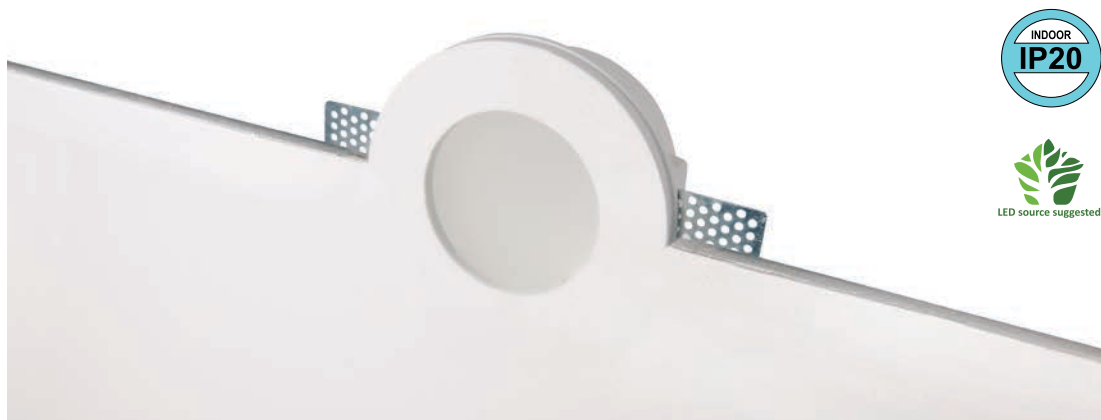

Type	Part n°	Dimensions mm	Standard	Colour	 mm	Packing box dimensions (mm)	Packing box (kg)
OBLÒ GLASS T1B	<b>B9132GV50T1B</b>	Ø120x63h	MR16	White	Ø125	200x170x113	0,64

Vedere pagina 168 per i kit che includono la lampadina LED - See page 168 for kits including LED lamp

### Incasso in Gypsolyte per controsoffitti (per moduli LED)

- L'aggiunta di un vetro satinato permette di eliminare l'abbagliamento della fonte di luce
- Incasso invisibile per controsoffitti
- Dopo aver rasato a gesso il controsoffitto, l'incasso risulta parte integrante del soffitto stesso e può essere tinteggiato
- Apertura per installazione Ø125 mm.
- Adatto a moduli LED standard MR16

### Gypsolyte fitting for counter ceiling (for LED modules)

- A frosted glass avoids dazzle
- Invisible fitting for counter ceilings
- Once the counter ceiling is finished with smoothing plaster, the fitting is almost invisible and can be painted together with the ceiling
- Installation hole mm Ø125
- Suitable for standard MR16 LED modules

### Einbaustrahler aus Gypsolyte für Unterdecken (für Led-Modulen geeignet)

- Der Zusatz einer Milchglas macht es möglich, den Schein der Lichtquelle zu beseitigen
- Unsichtbare Einbaustrahler für Unterdecken
- Sobald die Unterdecke durch Gips glatt gemacht ist, wird der Einbaustrahler fast unsichtbar und kann zusammen mit der Unterdecke gemalt werden
- Montageöffnung Ø125 mm.
- Für Standard MR16 LED-Module geeignet

### Encastrable en Gypsolyte pour plafond (pour modules à LED)

- L'ajout d'une vitre satinée permet d'éliminer l'éblouissement dû à la source de lumière
- Encastrable invisible pour faux plafond
- Après avoir lissé le faux-plafond, le boîtier encastrable devient partie intégrante du faux-plafond lui même et peut être peint
- Ouverture dans le plafond pour l'installation: Ø125 mm.
- Adapté aux modules LED MR16 standard

### Cazoleta para falso techo (para módulos de LED) in Gypsolyte

- Un cristal esmerilado evita los deslumbramientos
- Cazoleta para falso techo Gypsolyte (para módulos de LED)
- Cazoleta invisible para falsos techos
- Una vez terminado el falso techo con yeso la carcasa es casi invisible y puede ser pintado junto con el techo
- Medidas del orificio para la instalación Ø125 mm.
- Apropiado para módulos estándar de LED MR16

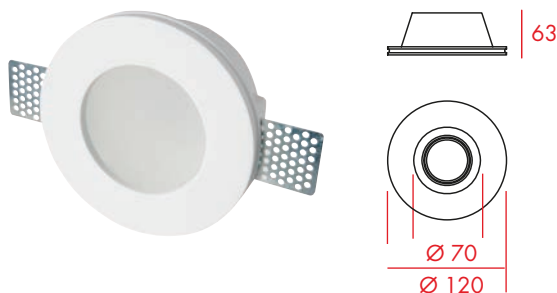

# OBLÒ FLAT

QUALIKO  
PROFESSIONAL LIGHT COMPONENTS srl



Incassi Gypsolyte • Gypsolyte fixtures



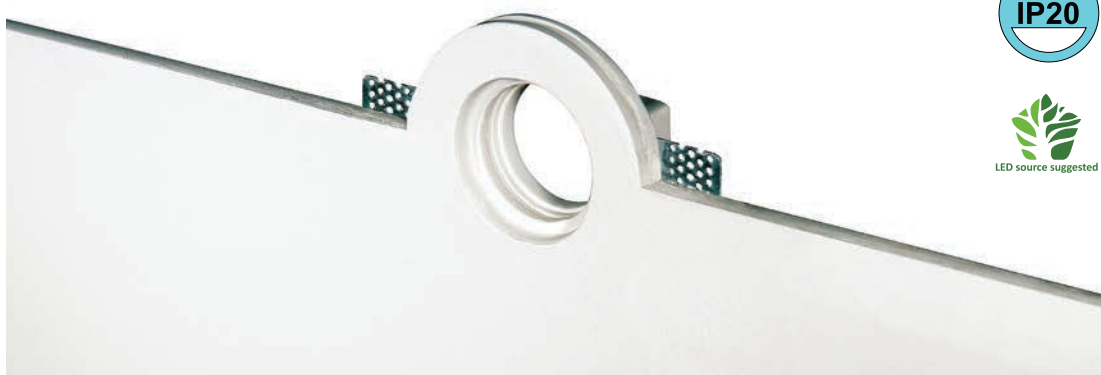

Type	Part n°	Dimensions mm	Standard	Colour	 mm	Packing box dimensions (mm)	Packing box (kg)
OBLÒ FLAT T1B	<b>B9224G050T1B</b>	Ø100x27h	MR16	White	Ø105	150x150x80	0,26

Vedere pagina 168 per i kit che includono la lampadina LED - See page 168 for kits including LED lamp

### Incasso in Gypsolyte per controsoffitti (per moduli LED)

- Incasso invisibile per controsoffitti
- Dopo aver rasato a gesso il controsoffitto, l'incasso risulta parte integrante del soffitto stesso e può essere tinteggiato
- Apertura per installazione Ø105 mm.
- Adatto a moduli LED standard MR16

### Gypsolyte fitting for counter ceiling (for LED modules)

- Invisible fitting for counter ceilings
- Once the counter ceiling is finished with smoothing plaster, the fitting is almost invisible and can be painted together with the ceiling
- Installation hole mm Ø105
- Suitable for standard MR16 LED modules

### Einbaustrahler aus Gypsolyte für Unterdecken (für Led-Modulen geeignet)

- Unsichtbare Einbaustrahler für Unterdecken
- Sobald die Unterdecke durch Gips glatt gemacht ist, wird der Einbaustrahler fast unsichtbar und kann zusammen mit der Unterdecke gemalt werden
- Montageöffnung Ø105 mm.
- Für Standard MR16 LED-Module geeignet

### Encastrable en Gypsolyte pour plafond (pour modules à LED)

- Encastrable invisible pour faux plafond
- Après avoir lissé le faux-plafond, le boîtier encastrable devient partie intégrante du faux-plafond lui même et peut être peint
- Ouverture dans le plafond pour l'installation: Ø105 mm.
- Adapté aux modules LED MR16 standard

### Cazoleta para falso techo (para módulos de LED) in Gypsolyte

- Cazoleta para falso techo Gypsolyte (para módulos de LED)
- Cazoleta invisible para falsos techos
- Una vez terminado el falso techo con yeso la carcasa es casi invisible y puede ser pintado junto con el techo
- Medidas del orificio para la instalación Ø105 mm.
- Apropriado para módulos estándar de LED MR16



- Ø60-

Ø100

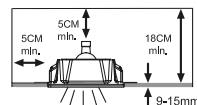



Incassi Gypsolyte • Gypsolyte fixtures



Type	Part n°	Dimensions mm	Standard	Colour	 mm	Packing box dimensions (mm)	Packing box (kg)
SLIDE Q1B	<b>B9131G050Q1B</b>	120x120x40h	MR16	White	125x125	170x170x110	0,52

Vedere pagina 168 per i kit che includono la lampadina LED - See page 168 for kits including LED lamp

**Incasso in Gypsolyte per controsoffitti (per moduli LED)**

- Incasso invisibile per controsoffitti
- Dopo aver rasato a gesso il controsoffitto, l'incasso risulta parte integrante del soffitto stesso e può essere tinteggiato
- Apertura per installazione 125x125 mm.
- Adatto a moduli LED standard MR16

**Gypsolyte fitting for counter ceiling (for LED modules)**

- Invisible fitting for counter ceilings
- Once the counter ceiling is finished with smoothing plaster, the fitting is almost invisible and can be painted together with the ceiling
- Installation hole mm 125x125
- Suitable for standard MR16 LED modules

**Einbaustrahler aus Gypsolyte für Unterdecken (für Led-Modulen geeignet)**

- Unsichtbare Einbaustrahler für Unterdecken
- Sobald die Unterdecke durch Gips glatt gemacht ist, wird der Einbaustrahler fast unsichtbar und kann zusammen mit der Unterdecke gemalt werden
- Montageöffnung 125x125 mm.
- Für Standard MR16 LED-Module geeignet

**Encastrable en Gypsolyte pour plafond (pour modules à LED)**

- Encastrable invisible pour faux plafond
- Après avoir lissé le faux-plafond, le boîtier encastrable devient partie intégrante du faux-plafond lui même et peut être peint
- Ouverture dans le plafond pour l'installation: 125x125 mm.
- Adapté aux modules LED MR16 standard

**Cazoleta para falso techo (para módulos de LED) in Gypsolyte**

- Cazoleta para falso techo Gypsolyte (para módulos de LED)
- Cazoleta invisible para falsos techos
- Una vez terminado el falso techo con yeso la carcasa es casi invisible y puede ser pintado junto con el techo
- Medidas del orificio para la instalación 125x125 mm.
- Apropriado para módulos estándar de LED MR16

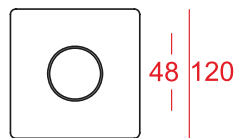

# DIAGONAL

QUALIKO<sup>srl</sup>  
PROFESSIONAL LIGHT COMPONENTS



Incassi Gypsolyte • Gypsolyte fixtures



Type	Part n°	Dimensions mm	Standard	Colour	 mm	Packing box dimensions (mm)	Packing box (kg)
DIAGONAL Q1B	<b>B9229G050Q1B</b>	120x120x65h	MR16	White	125x125	170x170x110	0,75

Vedere pagina 168 per i kit che includono la lampadina LED - See page 168 for kits including LED lamp

### Incasso in Gypsolyte per controsoffitti (per moduli LED)

- Incasso invisibile per controsoffitti
- Dopo aver rasato a gesso il controsoffitto, l'incasso risulta parte integrante del soffitto stesso e può essere tinteggiato
- Apertura per installazione 125x125 mm.
- Adatto a moduli LED standard MR16

### Gypsolyte fitting for counter ceiling (for LED modules)

- Invisible fitting for counter ceilings
- Once the counter ceiling is finished with smoothing plaster, the fitting is almost invisible and can be painted together with the ceiling
- Installation hole mm 125x125
- Suitable for standard MR16 LED modules

### Einbaustrahler aus Gypsolyte für Unterdecken (für Led-Modulen geeignet)

- Unsichtbare Einbaustrahler für Unterdecken
- Sobald die Unterdecke durch Gips glatt gemacht ist, wird der Einbaustrahler fast unsichtbar und kann zusammen mit der Unterdecke gemalt werden
- Montageöffnung 125x125 mm.
- Für Standard MR16 LED-Module geeignet

### Encastrable en Gypsolyte pour plafond (pour modules à LED)

- Encastrable invisible pour faux plafond
- Après avoir lissé le faux-plafond, le boîtier encastrable devient partie intégrante du faux-plafond lui même et peut être peint
- Ouverture dans le plafond pour l'installation: 125x125 mm.
- Adapté aux modules LED MR16 standard

### Cazoleta para falso techo (para módulos de LED) in Gypsolyte

- Cazoleta para falso techo Gypsolyte (para módulos de LED)
- Cazoleta invisible para falsos techos
- Una vez terminado el falso techo con yeso la carcasa es casi invisible y puede ser pintado junto con el techo
- Medidas del orificio para la instalación 125x125 mm.



65

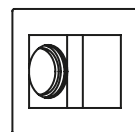

70 120

88

120





Incassi Gypsolyte • Gypsolyte fixtures

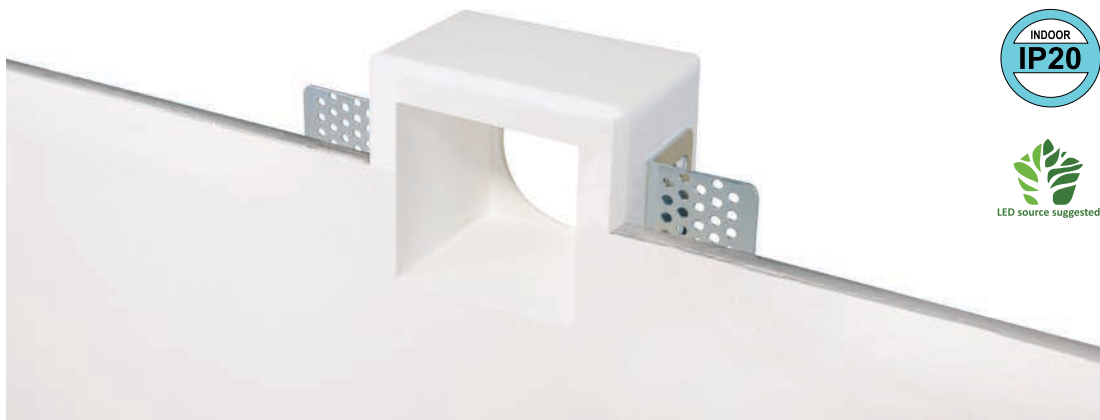

Type	Part n°	Dimensions mm	Standard	Colour	 mm	Packing box dimensions (mm)	Packing box (kg)
BEAT Q1B	<b>B9284G050Q1B</b>	80x80x53h	MR16	White	83x83	125x125x100	0,45

Vedere pagina 168 per i kit che includono la lampadina LED - See page 168 for kits including LED lamp

**Incasso in Gypsolyte per controsoffitti (per moduli LED)**

- Incasso invisibile per controsoffitti
- Dopo aver rasato a gesso il controsoffitto, l'incasso risulta parte integrante del soffitto stesso e può essere tinteggiato
- Apertura per installazione 83x83 mm.
- Adatto a moduli LED standard MR16

**Gypsolyte fitting for counter ceiling (for LED modules)**

- Invisible fitting for counter ceilings
- Once the counter ceiling is finished with smoothing plaster, the fitting is almost invisible and can be painted together with the ceiling
- Installation hole mm 83x83
- Suitable for standard MR16 LED modules

**Einbaustrahler aus Gypsolyte für Unterdecken (für Led-Modulen geeignet)**

- Unsichtbare Einbaustrahler für Unterdecken
- Sobald die Unterdecke durch Gips glatt gemacht ist, wird der Einbaustrahler fast unsichtbar und kann zusammen mit der Unterdecke gemalt werden
- Montageöffnung 83x83 mm.
- Für Standard MR16 LED-Module geeignet

**Encastrable en Gypsolyte pour plafond (pour modules à LED)**

- Encastrable invisible pour faux plafond
- Après avoir lissé le faux-plafond, le boîtier encastrable devient partie intégrante du faux-plafond lui même et peut être peint
- Ouverture dans le plafond pour l'installation: 83x83 mm.
- Adapté aux modules LED MR16 standard

**Cazoleta para falso techo (para módulos de LED) in Gypsolyte**

- Cazoleta para falso techo Gypsolyte (para módulos de LED)
- Cazoleta invisible para falsos techos
- Una vez terminado el falso techo con yeso la carcasa es casi invisible y puede ser pintado junto con el techo
- Medidas del orificio para la instalación 83x83 mm.
- Apropiado para módulos estándar de LED MR16

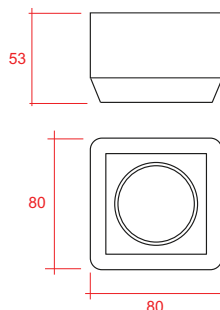



Incassi Gypsolyte • Gypsolyte fixtures



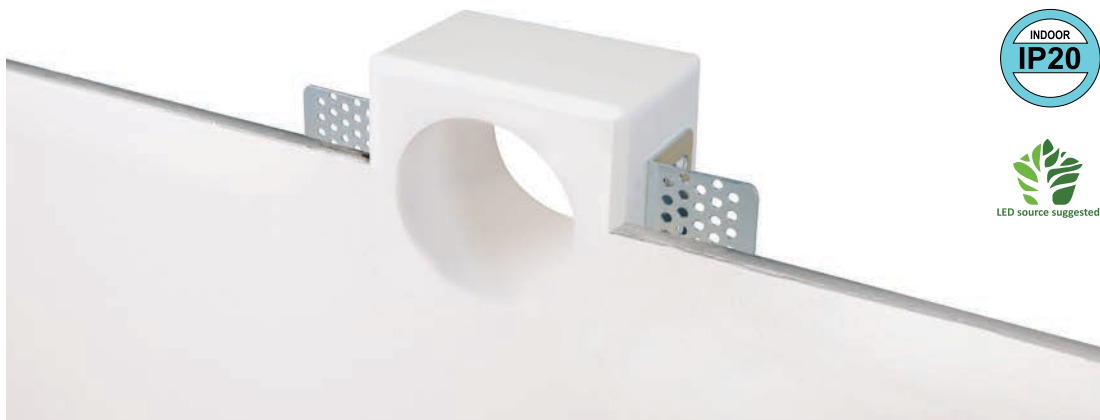

Type	Part n°	Dimensions mm	Standard	Colour	 mm	Packing box dimensions (mm)	Packing box (kg)
SOUL T1B	<b>B9285G050T1B</b>	80x80x53h	MR16	White	83x83	125x125x100	0,45

Vedere pagina 168 per i kit che includono la lampadina LED - See page 168 for kits including LED lamp

**Incasso in Gypsolyte per controsoffitti (per moduli LED)**

- Incasso invisibile per controsoffitti
- Dopo aver rasato a gesso il controsoffitto, l'incasso risulta parte integrante del soffitto stesso e può essere tinteggiato
- Apertura per installazione 83x83 mm.
- Adatto a moduli LED standard MR16

**Gypsolyte fitting for counter ceiling (for LED modules)**

- Invisible fitting for counter ceilings
- Once the counter ceiling is finished with smoothing plaster, the fitting is almost invisible and can be painted together with the ceiling
- Installation hole mm 83x83
- Suitable for standard MR16 LED modules

**Einbaustrahler aus Gypsolyte für Unterdecken (für Led-Modulen geeignet)**

- Unsichtbare Einbaustrahler für Unterdecken
- Sobald die Unterdecke durch Gips glatt gemacht ist, wird der Einbaustrahler fast unsichtbar und kann zusammen mit der Unterdecke gemalt werden
- Montageöffnung 83x83 mm.
- Für Standard MR16 LED-Module geeignet

**Encastrable en Gypsolyte pour plafond (pour modules à LED)**

- Encastrable invisible pour faux plafond
- Après avoir lissé le faux-plafond, le boîtier encastrable devient partie intégrante du faux-plafond lui même et peut être peint
- Ouverture dans le plafond pour l'installation: 83x83 mm.
- Adapté aux modules LED MR16 standard

**Cazoleta para falso techo (para módulos de LED) in Gypsolyte**

- Cazoleta para falso techo Gypsolyte (para módulos de LED)
- Cazoleta invisible para falsos techos
- Una vez terminado el falso techo con yeso la carcasa es casi invisible y puede ser pintado junto con el techo
- Medidas del orificio para la instalación 83x83 mm.
- Apropriado para módulos estándar de LED MR16

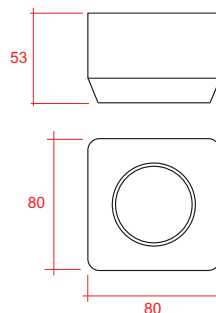



Incassi Gypsolyte • Gypsolyte fixtures

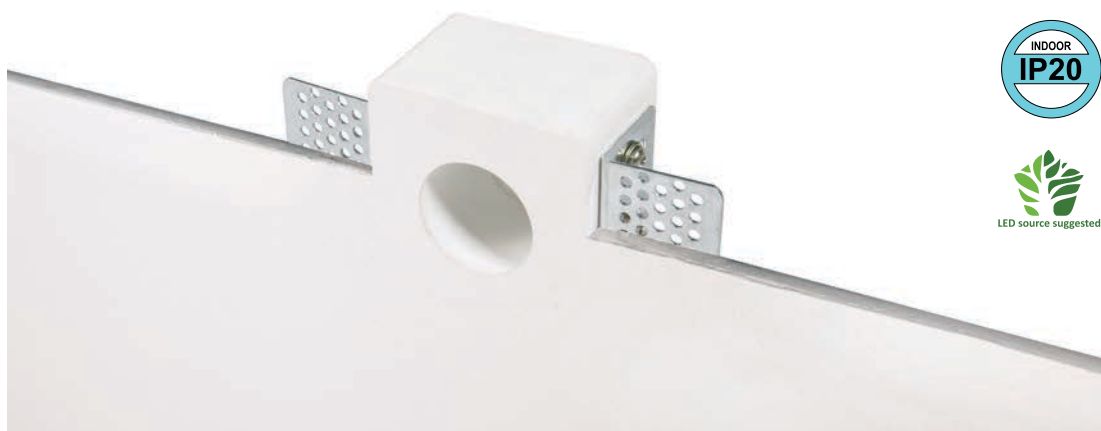

Type	Part n°	Dimensions mm	Standard	Colour	 mm	Packing box dimensions (mm)	Packing box (kg)
SNAP Q1B	<b>B9286G035Q1B</b>	60x60x37h	MR8	White	63x63	100x105x110	0,25

Verdere pagina 168 per i kit che includono la lampadina LED - See page 168 for kits including LED lamp

 **Incasso in Gypsolyte per controsoffitti (per moduli LED)**

- Incasso invisibile per controsoffitti
- Dopo aver rasato a gesso il controsoffitto, l'incasso risulta parte integrante del soffitto stesso e può essere tinteggiato
- Apertura per installazione 63x63 mm.
- Adatto a moduli LED standard MR8 (con adattatore **BAT30X23500B**)

 **Gypsolyte fitting for counter ceiling (for LED modules)**

- Invisible fitting for counter ceilings
- Once the counter ceiling is finished with smoothing plaster, the fitting is almost invisible and can be painted together with the ceiling
- Installation hole mm 63x63
- Suitable for standard MR8 LED modules (with adapter **BAT30X23500B**)

 **Einbaustrahler aus Gypsolyte für Unterdecken (für Led-Modulen geeignet)**

- Unsichtbare Einbaustrahler für Unterdecken
- Sobald die Unterdecke durch Gips glatt gemacht ist, wird der Einbaustrahler fast unsichtbar und kann zusammen mit der Unterdecke gemalt werden
- Montageöffnung 63x63 mm.
- Für Standard MR8 LED-Module geeignet (mit Adaptator **BAT30X23500B**)

 **Encastrable en Gypsolyte pour plafond (pour modules à LED)**

- Encastrable invisible pour faux plafond
- Après avoir lissé le faux-plafond, le boîtier encastrable devient partie intégrante du faux-plafond lui même et peut être peint
- Ouverture dans le plafond pour l'installation: 63x63 mm.
- Adapté aux modules LED MR8 standard (avec adaptateur **BAT30X23500B**)

 **Cazoleta para falso techo (para módulos de LED) in Gypsolyte**

- Cazoleta para falso techo Gypsolyte (para módulos de LED)
- Cazoleta invisible para falsos techos
- Una vez terminado el falso techo con yeso la carcasa es casi invisible y puede ser pintado junto con el techo
- Medidas del orificio para la instalación 63x63 mm.
- Apropriadado para módulos estándar de LED MR8 (con adaptador **BAT30X23500B**)

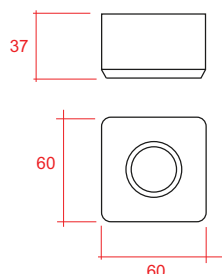

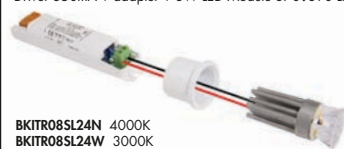

Optional Kit:  
Driver 350mA + adapter + 3W LED Module 370+390 Lm



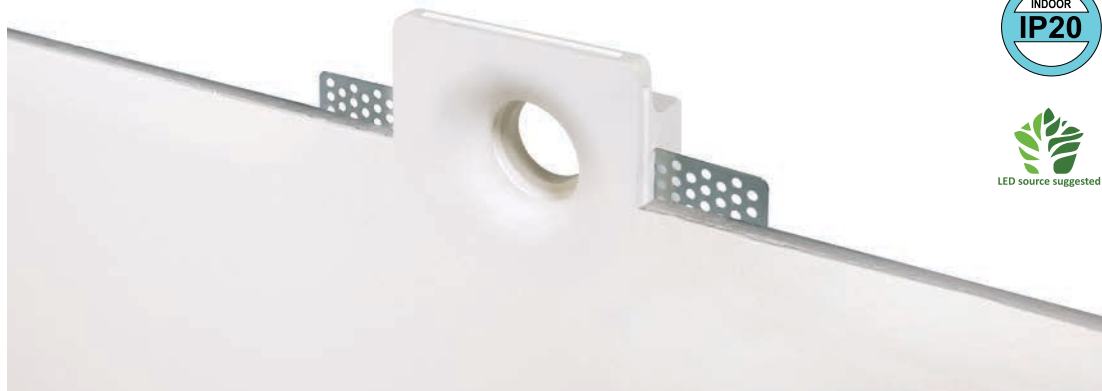

Incassi Gypsolyte • Gypsolyte fixtures



Type	Part n°	Dimensions mm	Standard	Colour	 mm	Packing box dimensions (mm)	Packing box (kg)
LOOP Q1B	<b>B9287G035Q1B</b>	80x80x32h	MR8	White	83x83	157x130x110	0,25

Vedere pagina 168 per i kit che includono la lampadina LED - See page 168 for kits including LED lamp

**Incasso in Gypsolyte per controsoffitti (per moduli LED)**

- Incasso invisibile per controsoffitti
- Dopo aver rasato a gesso il controsoffitto, l'incasso risulta parte integrante del soffitto stesso e può essere tinteggiato
- Apertura per installazione 83x83 mm.
- Adatto a moduli LED standard MR8 (con adattatore **BAT30X23500B**)

**Gypsolyte fitting for counter ceiling (for LED modules)**

- Invisible fitting for counter ceilings
- Once the counter ceiling is finished with smoothing plaster, the fitting is almost invisible and can be painted together with the ceiling
- Installation hole mm 83x83
- Suitable for standard MR8 LED modules (with adapter **BAT30X23500B**)

**Einbaustrahler aus Gypsolyte für Unterdecken (für Led-Modulen geeignet)**

- Unsichtbare Einbaustrahler für Unterdecken
- Sobald die Unterdecke durch Gips glatt gemacht ist, wird der Einbaustrahler fast unsichtbar und kann zusammen mit der Unterdecke gemalt werden
- Montageöffnung 83x83 mm.
- Für Standard MR8 LED-Module geeignet (mit Adaptator **BAT30X23500B**)

**Encastrable en Gypsolyte pour plafond (pour modules à LED)**

- Encastrable invisible pour faux plafond
- Après avoir lissé le faux-plafond, le boîtier encastrable devient partie intégrante du faux-plafond lui même et peut être peint
- Ouverture dans le plafond pour l'installation: 83x83 mm.
- Adapté aux modules LED MR8 standard (avec adaptateur **BAT30X23500B**)

**Cazoleta para falso techo (para módulos de LED) in Gypsolyte**

- Cazoleta para falso techo Gypsolyte (para módulos de LED)
- Cazoleta invisible para falsos techos
- Una vez terminado el falso techo con yeso la carcasa es casi invisible y puede ser pintado junto con el techo
- Medidas del orificio para la instalación 83x83 mm.
- Apropriadado para módulos estándar de LED MR8 (con adaptador **BAT30X23500B**)

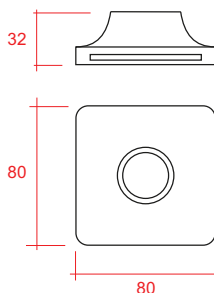
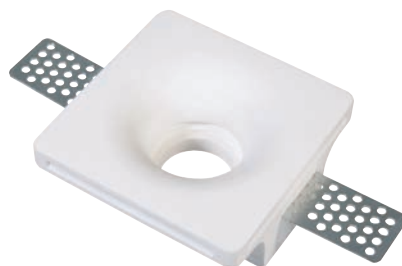

Optional Kit:  
Driver 350mA + adapter + 3W LED Module 370+390 Lm

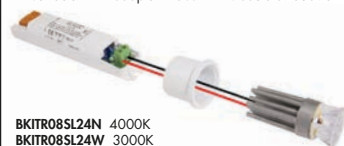



Strutture Gypsolyte • Gypsolyte fixtures



Type	Part n°	Dimensions mm	Standard	Colour	Packing box dimensions (mm)	Packing box (kg)
NEOS SMALL	<b>B9262G050Q1B</b>	71x71x90h	MR16	White	120x120x135h	0,47
NEOS MEDIUM	<b>B9263G050Q1B</b>	71x71x129h	MR16	White	120x120x180h	0,64
NEOS LARGE	<b>B9264G050Q1B</b>	71x71x169h	MR16	White	120x120x210h	0,84

Vedere pagina 168 per i kit che includono la lampadina LED - See page 168 for kits including LED lamp

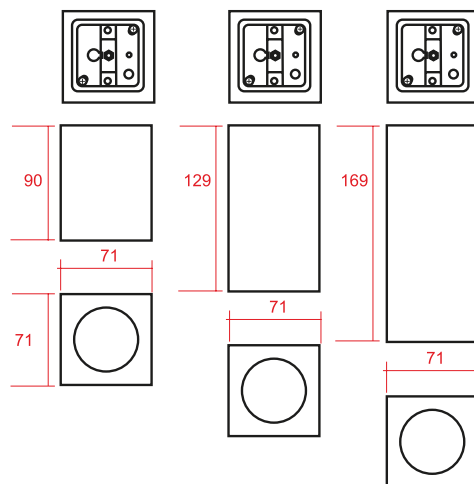

**Alloggiamento da soffitto in Gypsolyte**

- Struttura in Gypsolyte
- Adatto a moduli LED standard MR16
- Installazione a soffitto

**Gypsolyte fixture for ceiling**

- Structure in Gypsolyte
- Suitable for standard MR16 LED modules
- To be installed on ceiling

**Deckeneinbau aus Gypsolyte**

- Körper aus Gypsolyte
- Für Standard MR16 LED
- Module geeignet- Deckeneinsatz

**Structure pour plafond en Gypsolyte**

- Corps en Gypsolyte
- Adapté aux modules LED MR16 standard
- Installation au plafond

**Estructura para techo**

- Estructura de Gypsolyte
- Apropriado para modulos estandar LED MR16
- Instalacion para techo





Strutture Gypsolyte • Gypsolyte fixtures





Type	Part n°	Dimensions mm	Standard	Colour	Packing box dimensions (mm)	Packing box (kg)
ARGO SMALL	<b>B9268G050T1B</b>	Ø70x90h	MR16	White	120x120x135h	0,46
ARGO MEDIUM	<b>B9269G050T1B</b>	Ø70x130h	MR16	White	120x120x180h	0,61
ARGO LARGE	<b>B9270G050T1B</b>	Ø70x170h	MR16	White	120x120x210h	0,76

Vedere pagina 168 per i kit che includono la lampadina LED - See page 168 for kits including LED lamp

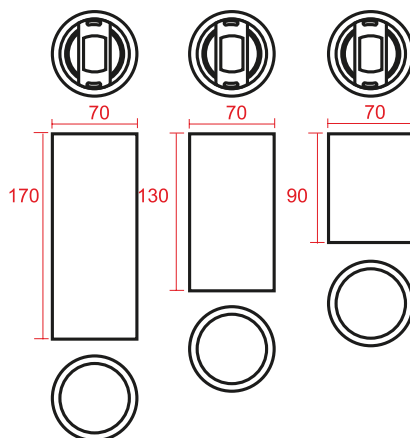

**Alloggiamento da soffitto in Gypsolyte**

- Struttura in Gypsolyte
- Adatto a moduli LED standard MR16
- Installazione a soffitto

**Gypsolyte fixture for ceiling**

- Structure in Gypsolyte
- Suitable for standard MR16 LED modules
- To be installed on ceiling

**Deckeneinbau aus Gypsolyte**

- Körper aus Gypsolyte
- Für Standard MR16 LED
- Module geeignet- Deckeneinsatz

**Structure pour plafond en Gypsolyte**

- Corps en Gypsolyte
- Adapté aux modules LED MR16 standard
- Installation au plafond

**Estructura para techo**

- Estructura de Gypsolyte
- Apropriado para modulos estandar LED MR16
- Instalacion para techo



# ROUND

QUALIKO<sup>srl</sup>  
PROFESSIONAL LIGHT COMPONENTS



Incassi LED • LED downlights



RAL 9010



24 Volt  
Safety Voltage



Versione DALI disponibile a richiesta  
DALI version available on request



Vedere pagina 168 per i kit che includono il driver LED - See page 168 for kits including LED driver



Type	Part N°	Dimensions (mm)	Colour	°Kelvin	Lumen	Power (W)	Installation hole (mm)	Packing box dimensions (mm)	Weight (kg)
ROUND 95 NW	BD09524TNW1B	Ø 95x28h	Natural White	4200°K	395	7	Ø 80	200x150x60h	0,21
ROUND 95 WW	BD09524TWW1B	Ø 95x28h	Warm White	3000°K	372	7	Ø 80	200x150x60h	0,21
ROUND 140 NW	BD14024TNW1B	Ø 140x28h	Natural White	4200°K	695	10	Ø 120	240x180x60h	0,33
ROUND 140 WW	BD14024TWW1B	Ø 140x28h	Warm White	3000°K	656	10	Ø 120	240x180x60h	0,33
ROUND 170 NW	BD17024TNW1B	Ø 170x31h	Natural White	4200°K	1066	14	Ø 145	260x200x60h	0,43
ROUND 170 WW	BD17024TWW1B	Ø 170x31h	Warm White	3000°K	1006	14	Ø 145	260x200x60h	0,43
ROUND 200 NW	BD20024TNW1B	Ø 200x31h	Natural White	4200°K	1195	16	Ø 180	330x230x60h	0,57
ROUND 200 WW	BD20024TWW1B	Ø 200x31h	Warm White	3000°K	1127	16	Ø 180	330x230x60h	0,57
ROUND 275 NW	BD27524TNW1B	Ø 275x31h	Natural White	4200°K	2167	27	Ø 250	380x340x60h	1,00
ROUND 275 WW	BD27524TWW1B	Ø 275x31h	Warm White	3000°K	2044	27	Ø 250	380x340x60h	1,00
ROUND 330 NW	BD33024TNW1B	Ø 330x31h	Natural White	4200°K	2876	34	Ø 310	470x360x60h	1,70
ROUND 330 WW	BD33024TWW1B	Ø 330x31h	Warm White	3000°K	2713	34	Ø 310	470x360x60h	1,70

### Incasso a LED tondo extrapiatto

- Cornice e struttura in alluminio verniciato
- Grande omogeneità luminosa
- Funziona in bassa tensione con trasformatore 24V DC specifico (fornito a richiesta)
- Consumo limitato
- Lunga durata

### Round extra flat recessed LED fixture

- Structure and frame in lacquered aluminium
- Extra flat
- Safety low voltage with specific 24V DC drivers (supplied on request)
- Limited consumption

### Runde extraflache LED Einbaustrahler

- Rahme und Körper aus lackiertem Aluminium
- NV-betrieb durch besonderen 24VDC Transformator (auf Anfrage geliefert)
- Begrenzter Verbrauch
- Lange lebensdauer

### Encastrable à LED rond extra plat

- Encadrement et corps en aluminium verni
- Luminosité très homogène
- Il marche en basse tension avec un transformateur 24V DC (livré sur demande)
- Consommation limitée
- Longue durée de vie

### Focos empotrables a LED extra plano

- Estructura y marco de aluminio pintado
- Excelente homogeneidad luminica
- Alta seguridad por funcionamiento a baja tension, con drivers específicos de 24VDC (bajo demanda)
- Bajo consume
- Larga vida



Incassi LED • LED downlights

Made in Italy



Versione DALI disponibile a richiesta  
DALI version available on request



Vedere pagina 168 per i kit che includono il driver LED - See page 168 for kits including LED driver



Type	Part N°	Dimensions (mm)	Colour	Lumen (lm)	Voltage Max (V)	Current Max (mA)	Beam °	Power Max (W)	Installation hole (mm)	Packing box dimensions (mm)	Weight (kg)
ORION 135 NW	<b>BD135CCTNW0B</b>	Ø 135x70h	NW 4000°K	940	19	700	80°	13	Ø 105	150x145x80	0,30
ORION 160 NW	<b>BD160CCTNW0B</b>	Ø 160x75h	NW 4000°K	1207	21	700	80°	15	Ø 130	210x190x110	0,45
ORION 190 NW	<b>BD190CCTNW0B</b>	Ø 190x95h	NW 4000°K	1595	25	700	80°	17	Ø 160	210x210x125	0,75
ORION 228 NW	<b>BD228CCTNW0B</b>	Ø 228x100h	NW 4000°K	2340	37	700	80°	26	Ø 200	255x250x130	1,20
ORION 135 WW	<b>BD135CCTWW0B</b>	Ø 135x70h	WW 3000°K	890	19	700	80°	13	Ø 105	150x145x80	0,30
ORION 160 WW	<b>BD160CCTWW0B</b>	Ø 160x75h	WW 3000°K	1150	21	700	80°	15	Ø 130	210x190x110	0,45
ORION 190 WW	<b>BD190CCTWW0B</b>	Ø 190x95h	WW 3000°K	1515	25	700	80°	17	Ø 160	210x210x125	0,75
ORION 228 WW	<b>BD228CCTWW0B</b>	Ø 228x100h	WW 3000°K	2223	37	700	80°	26	Ø 200	255x250x130	1,20

## Incasso a LED tondo ad alta potenza

- Cornice estetica e struttura dissipante in alluminio
- Grande omogeneità luminosa
- Per installazioni di tipo professionale
- Funziona in bassa tensione con trasformatore elettronico specifico a corrente costante (fornito a richiesta)
- Lunga durata

## Round extra powerful recessed LED downlight

- Dissipating structure and aesthetic frame in aluminum
- High brightness homogeneity
- For professional use
- Safety low voltage with specific constant current driver (supplied on request)
- Long life time

## LED Rundeinbaustrahler

- Ästhetische Rahme und Kühlkörper aus Aluminium
- Große Lichthomogenität
- Für berufliche Installationen geeignet
- Betrieb auf Niedervolt durch besonderen elektronischen Transformator auf Konstantstrom (nur auf Anfrage)
- Lange Lebensdauer

## Encastrement LED rond haute puissance

- Encadrement esthétique et structure dissipante en aluminium
- Grande homogénéité lumineuse
- Pour installations de type professionnel
- Fonctionne à basse tension avec un transformateur électronique spécifique à courant constant (fourni sur demande)
- Longue durée de vie

## Focos empotrables a LED de alta potencia

- Estructura de disipación y marco estético en aluminio
- Alta y homogénea luminosidad
- Para uso profesional
- Baja tensión con convertidor de corriente constante específico (suministrado bajo demanda)
- Larga duración





Incassi LED • LED downlights



Vedere pagina 168 per i kit che includono il driver LED - See page 168 for kits including LED driver



Type	Part N°	Dimensions (mm)	Colour	Lumen (lm)	Voltage Max (V)	Current Max (mA)	Beam °	Power Max (W)	Installation hole (mm)	Packing box dimensions (mm)	Weight (kg)
LAKE SMALL NW	<b>BDCL102A08NB</b>	Ø 80x30h	NW 4000°K	1000	38	185	60°	8	Ø 70	115x110x75	0,25
LAKE SMALL WW	<b>BDCL102A08WB</b>	Ø 80x30h	WW 3000°K	990	38	185	60°	8	Ø 70	115x110x75	0,25
LAKE LARGE NW	<b>BDCL102A13NB</b>	Ø 110x50h	NW 4000°K	1690	38	300	60°	13	Ø 95	135x125x110	0,45
LAKE LARGE WW	<b>BDCL102A13WB</b>	Ø 110x50h	WW 3000°K	1640	38	300	60°	13	Ø 95	135x125x110	0,45

### Incasso a LED tondo ad alta potenza IP65 - CRI>80

- Cornice estetica e struttura dissipante in alluminio
- Orientabile
- Grande omogeneità luminosa
- Per installazioni di tipo professionale
- Funziona in bassa tensione con trasformatore elettronico specifico a corrente costante (fornito a richiesta)
- Lunga durata

### Focos empotrables a LED de alta potencia IP65 - CRI>80

- Estructura de disipación y marco estético en aluminio
- Ajustable
- Alta y homogénea luminosidad
- Para uso profesional
- Baja tensión con convertidor de corriente constante específico (suministrado bajo demanda)
- Larga duración

### Round IP65 extra powerful recessed LED downlight - CRI>80

- Dissipating structure and aesthetic frame in aluminum
- Adjustable
- High brightness homogeneity
- For professional use
- Safety low voltage with specific constant current driver (supplied on request)
- Long life time

### IP65 LED Rundenbastrahler - CRI>80

- Ästhetische Rahme und Kühlkörper aus Aluminium
- Schwenkbar
- Große Lichthomogenität
- Für berufliche Installationen geeignet
- Betrieb auf Niedervolt durch besonderen elektronischen Transformator auf Konstantstrom (nur auf Anfrage)
- Lange Lebensdauer

### Encastrement LED rond haute puissance IP65 - CRI>80

- Encadrement esthétique et structure dissipante en aluminium
- Orientable
- Grande homogénéité lumineuse
- Pour installations de type professionnel
- Fonctionne à basse tension avec un transformateur électronique spécifique à courant constant (fourni sur demande)
- Longue durée de vie



# OPERA

QUALIKO<sup>srl</sup>  
PROFESSIONAL LIGHT COMPONENTS



Incassi LED • LED downlights



# OPERA Incassi LED • LED downlights

QUALIKO

Made in Italy



Versione DALI disponibile a richiesta  
DALI version available on request



Vedere pagina 168 per i kit che includono il driver LED - See page 168 for kits including LED driver

CE III EMC IP52 RoHS



Type	Part N°	Dimensions (mm)	Colour	Lumen (lm)	Voltage Max (V)	Current Max (mA)	Beam °	Power Max (W)	Installation hole (mm)	Packing box dimensions (mm)	Weight (kg)
OPERA Small NW	BD19BAS0TNWB	Ø 152x125h	NW 4000°K	1935	37	500	40°	19	Ø 138	170x170x130	0,65
OPERA Large NW	BD27BAS0TNWB	Ø 186x150h	NW 4000°K	2396	38	700	50°	27	Ø 170	200x200x170	1,15
OPERA Small WW	BD19BAS0TWWB	Ø 152x125h	WW 3000°K	1811	37	500	40°	19	Ø 138	170x170x130	0,65
OPERA Large WW	BD27BAS0TWWB	Ø 186x150h	WW 3000°K	2037	38	700	50°	27	Ø 170	200x200x170	1,15

## Incasso a LED orientabile ad alta potenza

- Orientabile da 0° a 60°
- Grande omogeneità luminosa
- Per installazioni di tipo professionale
- Funziona in bassa tensione con trasformatore elettronico specifico (fornito a richiesta)
- Lunga durata

## Adjustable round extra powerful recessed LED downlight

- Adjustable from 0° to 60°
- High brightness homogeneity
- For professional use
- Safety low voltage with specific driver (supplied on request)
- Long life time

## Rund High Power LED-Einbastrahler (schwenkbar)

- Schwenkbar ab 0° zu 60°
- Große Lichthomogenität
- Für berufliche Installationen geeignet
- Betrieb auf Niedervolt durch besonderen elektronischen Transformator auf Konstantstrom (nur auf Anfrage)
- Lange Lebensdauer

## Encastrable à LED rond orientable à haute puissance

- Orientable de 0° à 60°
- Grande homogénéité lumineuse
- Pour installations de type professionnel
- Fonctionne à basse tension avec un transformateur électronique

- spécifique à courant constant (fourni sur demande)
- Longue durée de vie

## Focos empotrables a LED de alta potencia (ajustable)

- Ajustable de 0° a 60°
- Alta y homogenea luminosidad
- Para uso profesional
- Baja tension con convertidor de corriente constante especifico (suministrado bajo demada)
- Larga duracion





Incassi LED • LED downlights



Versione DALI disponibile a richiesta  
DALI version available on request



Vedere pagina 168 per i kit che includono il driver LED - See page 168 for kits including LED driver



Type	Part N°	Dimensions (mm)	Colour	Lumen (Lm)	Voltage Max (V)	Current Max (mA)	Beam °	Power Max (W)	Installation hole (mm)	Packing box dimensions (mm)	Weight (kg)
KARMA Small NW	<b>BD13BASOQNW</b>	100x100x67h	NW 4000°K	1246	37	350	40°	13	85x85	110x170x120	0,35
KARMA Large NW	<b>BD28BASOQNW</b>	145x145x110h	NW 4000°K	2513	38	700	50°	27	138x138	180x180x140	1,25
KARMA Small WW	<b>BD13BASOQWW</b>	100x100x67h	WW 3000°K	1185	37	350	40°	13	85x85	110x170x120	0,35
KARMA Large WW	<b>BD28BASOQWW</b>	145x145x110h	WW 3000°K	2263	38	700	50°	27	138x138	180x180x140	1,25

### Incasso a LED quadrato orientabile ad alta potenza

- Orientabile da 0° a 80°
- Grande omogeneità luminosa
- Per installazioni di tipo professionale
- Funziona in bassa tensione con trasformatore elettronico specifico (fornito a richiesta)
- Lunga durata

### Square extra powerful recessed adjustable LED downlight

- Adjustable from 0° to 80°
- High brightness homogeneity
- For professional use
- Safety low voltage with specific driver (supplied on request)
- Long life time

### 4-eckige High Power LED-Einbaustrahler (schwenkbar)

- Schwenkbar ab 0° zu 80°
- Große Lichthomogenität
- Für berufliche Installationen geeignet
- Betrieb auf Niedervolt durch besonderen elektronischen Transformator auf Konstantstrom (nur auf Anfrage)
- Lange Lebensdauer

### Encastrable à LED carré orientable à haute puissance

- Orientable de 0° à 80°
- Grande homogénéité lumineuse
- Pour installations de type professionnel
- Fonctionne à basse tension avec un transformateur électronique

- spécifique à courant constant (fourni sur demande)
- Longue durée de vie

### Focos empotrables a LED de alta potencia

- Ajustable de 0° a 80°
- Alta y homogénea luminosidad
- Para uso profesional
- Baja tension con convertidor de corriente constante específico (suministrado bajo demanda)
- Larga duración



# EASY CCT Round

QUALIKO<sup>srl</sup>  
PROFESSIONAL LIGHT COMPONENTS

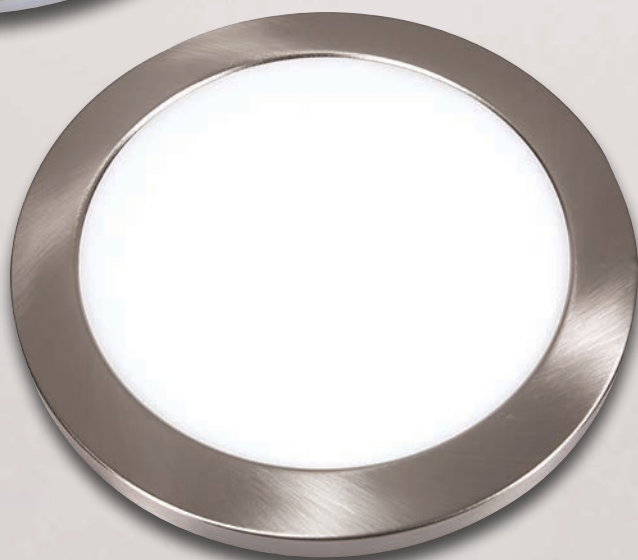

Incassi LED • LED downlights



**CONNECT  
230V  
DIRECT**

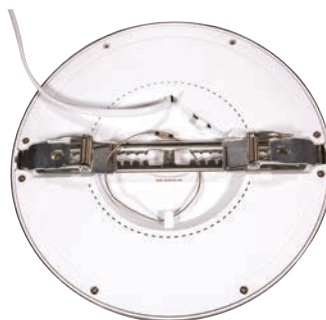

CE EMC IP20 RoHS

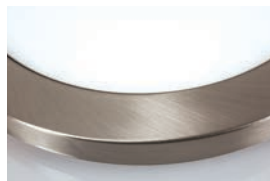

Type	Part N°	Dimensions (mm)	Colour	Lumen (Lm)	Input V	Beam °	Power Max (W)	Installation hole (mm)	Packing box dimensions (mm)	Weight (kg)
EASY CCT RD 12W	<b>BPR165MPL12B</b>	Ø 164x15h	3000 - 4000 - 6000K	921	200÷240	110°	12	Ø 55÷125	170x180x40h	0,33
	<b>BPRING165CHR</b>	Chrome magnetic ring for EASY CCT RD 12W (optional)								
	<b>BPRING165NKL</b>	Brushed Nickel magnetic ring for EASY CCT RD 12W (optional)								
EASY CCT RD 24W	<b>BPR290MPL24B</b>	Ø 292x15h	3000 - 4000 - 6000K	2158	200÷240	110°	24	Ø 55÷250	300x310x45h	0,85
	<b>BPRING290CHR</b>	Chrome magnetic ring for EASY CCT RD 24W (optional)								
	<b>BPRING290NKL</b>	Brushed Nickel magnetic ring for EASY CCT RD 24W (optional)								

- Incasso a LED tondo ad alta potenza 230V CCT**
- Selettore per scelta colore (3000K - 4000K - 6000K)
  - Installazione semplice e veloce
  - Funziona direttamente a tensione di rete con alimentatore incorporato - Lunga durata
  - Staffa per installazione regolabile per fori Ø 55÷125 mm (EASY 12) e Ø 55÷250 mm (EASY 24)
  - Anelli decorativi magnetici Cromo e Nickel spazzolato (optional)

- Round extra powerful 230V recessed CCT LED downlight**
- Switch for color setting (3000K - 4000K - 6000K)
  - Easy and quick installation
  - Works directly with mains voltage (Built-in driver) - Long life time
  - Adjustable bracket for installation in Ø 55÷125 mm (EASY 12) and Ø 55÷250 mm (EASY 24) holes
  - Decorative magnetic rings available Chrome and brushed Nickel (optional)

- CCT LED Rundeinbaustrahler 230V**
- Switch für Farbauswahl (3000K - 4000K - 6000K)
  - Einfache und schnelle Installation
  - Betrieb direkt auf 230V mit ein gebautem Led-Treiber
  - Lange Lebensdauer
  - Halteneigung zum verstellbaren Einbau für Bohrungen mit Ø 55÷125 mm (EASY 12) und Ø 55÷250 mm (EASY 24)
  - Dekorative magnetische Ringe aus gebürstetem Chrome und Nickel (optional)

- Encastrement LED rond CCT haute puissance 230V**
- Programmeur de teintes (3000K - 4000K - 6000K)
  - Installation simple et rapid
  - Alimentation intégrée, branchement direct sur le réseau

- Longue durée de vie
- Support pour installation orientable.
- Trous: Ø 55÷125 mm (EASY 12) et Ø 55÷250 mm (EASY 24)
- Enjoliveurs magnétiques décoratives en Chrome et Nickel brossé (optional)

- Focos empotrables a LED de alta potencia 230V CCT**
- Selector de colores (3000K - 4000K - 6000K)
  - Instalación rápida y fácil
  - Alimentación directa 230V (convertidor integrado)
  - Larga duración
  - Soporte para instalación ajustable para orificios de Ø 55÷125 mm (EASY 12) y Ø 55÷250 mm (EASY 24)
  - Anillos magnéticos decorativo Cromo y Nickel (opcional)

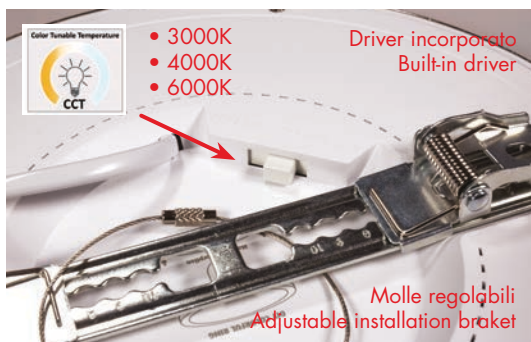

# EASY CCT Square

QUALIKO<sup>srl</sup>  
PROFESSIONAL LIGHT COMPONENTS



Incassi LED • LED downlights

# EASY CCT SQUARE Incassi LED • LED downlights

QUALIKO



Type	Part N°	Dimensions (mm)	Colour	Lumen (Lm)	Input V	Beam °	Power Max (W)	Installation hole (mm)	Packing box dimensions (mm)	Weight (kg)
EASY CCT SQ 12W	<b>BPS165MPL12B</b> <b>BPSRING165CH</b> <b>BPSRING165NK</b>	164x164x15h	3000 - 4000 - 6000K	1050	100÷240AC	110°	12	Ø 55÷125	170x185x45h	0,38
EASY CCT SQ 24W	<b>BPS290MPL24B</b> <b>BPSRING290CH</b> <b>BPSRING290NK</b>	292x292x15h	3000 - 4000 - 6000K	2200	100÷240AC	110°	24	Ø 55÷250	305x315x50h	1,10

## 🇮🇹 Incasso a LED quadrato ad alta potenza 230V CCT

- Selettore per scelta colore (3000K - 4000K - 6000K)
- Installazione semplice e veloce
- Funziona direttamente a tensione di rete con alimentatore incorporato - Lunga durata
- Staffa per installazione regolabile per fori Ø 55÷125 mm (EASY 12) e Ø 55÷250 mm (EASY 24)
- Cornici decorative magnetiche Cromo e Nickel spazzolato (optional)

## 🇬🇧 Square extra powerful 230V recessed CCT LED downlight

- Switch for color setting (3000K - 4000K - 6000K)
- Easy and quick installation
- Works directly with mains voltage (Built-in driver) - Long life time
- Adjustable bracket for installation in Ø 55÷125 mm (EASY 12) and Ø 55÷250 mm (EASY 24) holes
- Decorative magnetic frame available Chrome and brushed Nickel (optional)

## 🇩🇪 Viereckiger Einbaustrahler HV 230V CCT

- Switch für Farbauswahl (3000K - 4000K - 6000K)
- Einfache und schnelle Installation
- Betrieb direkt auf 230V mit ein gebautem Led-Treiber
- Lange Lebensdauer
- Haltenung zum verstellbaren Einbau für Bohrungen mit Ø 55÷125 mm (EASY 12) und Ø 55÷250 mm (EASY 24)
- Dekorative magnetische Rahme aus gebürstetem Chrome und Nickel (optional)

## 🇫🇷 Encastrable carré LED haute puissance 230V CCT

- Programmeur de teintes (3000K - 4000K - 6000K)
- Installation simple et rapid
- Alimentation intégrée, branchement direct sur le réseau

- Longue durée de vie
- Support pour installation orientable.
- Trous: Ø 55÷125 mm (EASY 12) et Ø 55÷250 mm (EASY 24)
- Enjoliveurs magnétiques décoratives en Chrome et Nickel brossé (optional)

## 🇪🇸 Focos empotrables cuadrados a LED de alta potencia 230V CCT

- Selector de colores (3000K - 4000K - 6000K)
- Instalación rápida y fácil
- Alimentación directa 230V (convertidor integrado)
- Larga duración
- Soporte para instalación ajustable para orificios de Ø 55÷125 mm (EASY 12) y Ø 55÷250 mm (EASY 24)
- Cornisas cuadradas magnéticas decorativas Cromo y Nickel (opcional)

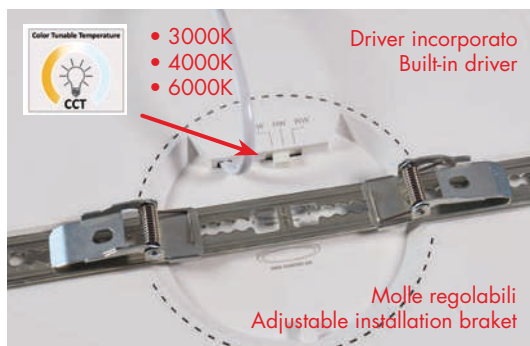



Incassi LED • LED downlights





CE EMC IP20 RoHS

Type	Part N°	Dimensions (mm)	Colour	Lumen (lm)	Input V	Beam °	Power Max (W)	Installation hole (mm)	Packing box dimensions (mm)	Weight (kg)
TUNE CCT 6W	<b>BDPL0806CCTB</b>	Ø 115x32h	3000 - 4200 - 6000K	480	175÷240	120°	6	Ø 105	119x119x47h	0,12
TUNE CCT 12W	<b>BDPL0812CCTB</b>	Ø 170x32h	3000 - 4200 - 6000K	960	175÷240	120°	12	Ø 155	174x174x47h	0,21

- Incasso a LED tondo ad alta potenza 230V CCT**
- Selettore per scelta colore (3000K - 4200K - 6000K)
  - Installazione semplice e veloce
  - Funziona direttamente a tensione di rete con alimentatore incorporato
  - Lunga durata

- Round extra powerful 230V recessed CCT LED downlight**
- Switch for color setting (3000K - 4200K - 6000K)
  - Easy and quick installation
  - Works directly with mains voltage (Built-in driver)
  - Long life time

- CCT LED Rundenbastrahler 230V**
- Switch für Farbauswahl (3000K - 4200K - 6000K)
  - Einfache und schnelle Installation
  - Betrieb direkt auf 230V mit ein gebautem Led-Treiber
  - Lange Lebensdauer

- Encastrement LED rond CCT haute puissance 230V**
- Programmeur de teintes (3000K - 4200K - 6000K)
  - Installation simple et rapid
  - Alimentation intégrée, branchement direct sur le réseau
  - Longue durée de vie

- Focos empotrables a LED de alta potencia 230V CCT**
- Selector de colores (3000K - 4200K - 6000K)
  - Instalación rápida y fácil
  - Alimentación directa 230V (convertidor integrado)
  - Larga duración

Connettere direttamente a 175÷240V  
Connect direct to 175÷240V

**CONNECT  
230V  
DIRECT**

Driver incorporato  
Built-in driver



- 3000K
- 4200K
- 6000K



# LED PANEL DRI

60x60

QUALIKO<sup>srl</sup>  
PROFESSIONAL LIGHT COMPONENTS

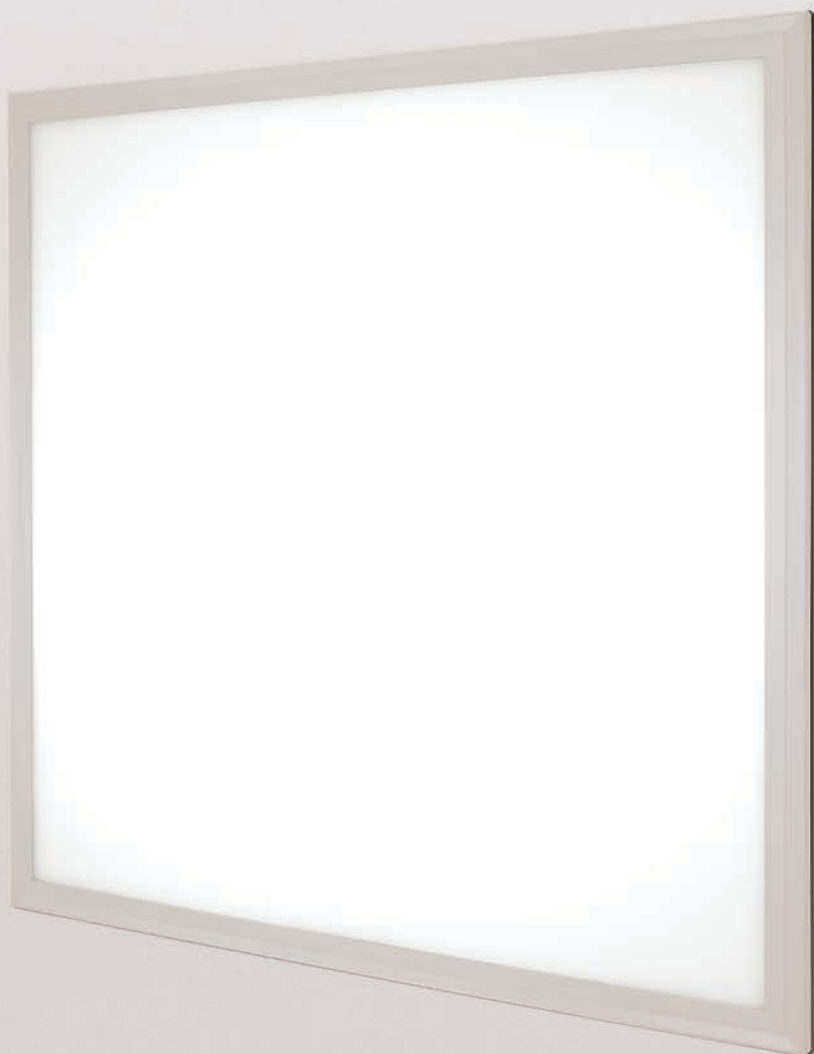

Pannelli LED • LED panels

# LED PANEL DRI 60x60 Pannelli LED • LED panels

QUALIKO



CE EMC IP20 RoHS

Optional: suspension kit - Part N°: BPLKIT4X150C



Optional: ceiling kit - Part N°: BPLKITCEIL1B

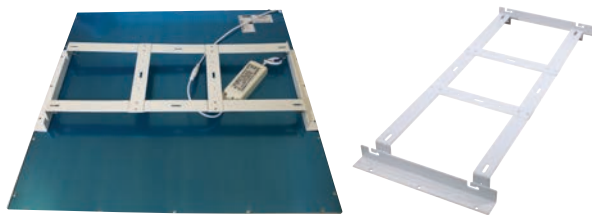

Optional: wall kit - Part N°: BPLKITWALL0B

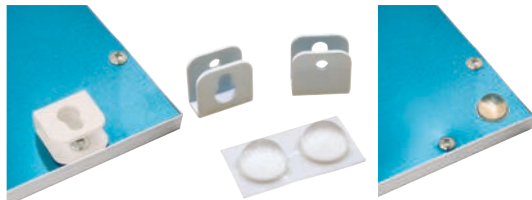

Optional: spring kit Part N°: BPLKITSPRING



Optional: closed ceiling kit (60x60 only)  
Part N°: BPLKITBOX00B White



Type	Part N°	Dimensions (mm)	Input (V)	Colour	Frame colour	°Kelvin	Lumen	Power (W)	Packing box dimensions (mm)	Weight (kg)
60x60 CW	<b>BPL6060DRICB</b>	595x595x10,5h	200±240	Cool White	White	6000°K	3918	36	670x620x30h	3,7
60x60 NW	<b>BPL6060DRINB</b>	595x595x10,5h	200±240	Natural White	White	4200°K	3407	36	670x620x30h	3,7
60x60 WW	<b>BPL6060DRIWB</b>	595x595x10,5h	200±240	Warm White	White	3000°K	2895	36	670x620x30h	3,7
60x60 UGR NW	<b>BPL60UGDRNB</b>	595x595x10,5h	200±240	Natural White	White	4200°K	3855	36	670x620x30h	3,7

## 🇮🇹 Pannello LED 60x60 DRI

- Cornice e struttura in alluminio
- Adatto per sostituire incassi standard per tubi fluo
- Grande omogeneità luminosa
- Funziona in bassa tensione con trasformatore 1A incluso
- Versione UGR <19 disponibile

## 🇬🇧 LED panel 60x60 DRI

- Structure and frame in aluminum
- Suitable for replacing standard fixtures for fluo tubes
- Great homogeneity of light
- Safety low voltage with 1A drivers included
- UGR <19 version available

## 🇩🇪 LED-Tafel 60x60 DRI

- Rahme und Körper aus Aluminium
- Für direkten Ersatz von standard Leuchtstoffröhren geeignet
- Groß Homogenität des Lichts- Dicke 10,5 mm
- 1A Led-Treiber dabei geliefert
- Ausführung UGR <19 verfügbar

## 🇫🇷 Panneau LED 60x60 DRI

- Encadrement et corps en aluminium
- Approprié pour le remplacement des encastrables standard à tubes fluo
- Luminosité très homogène

- Il marche en basse tension avec un convertisseur 1A livré avec
- Version UGR <19 disponible

## 🇪🇸 Panel LED 60x60 DRI

- Estructura y marco de aluminio
- Adecuado para remplazo directo de lampara estandar con tubos de fluorescencia
- Excelente homogeneidad luminica
- Alta seguridad por funcionamiento a baja tension, con drivers especificos de 1A (incluido)
- Versión UGR <19 disponible

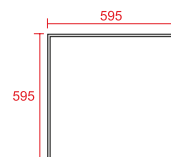

Versione DALI disponibile a richiesta  
DALI version available on request

# LED PANEL

60x60 • 60x120

QUALIKO<sup>srl</sup>  
PROFESSIONAL LIGHT COMPONENTS

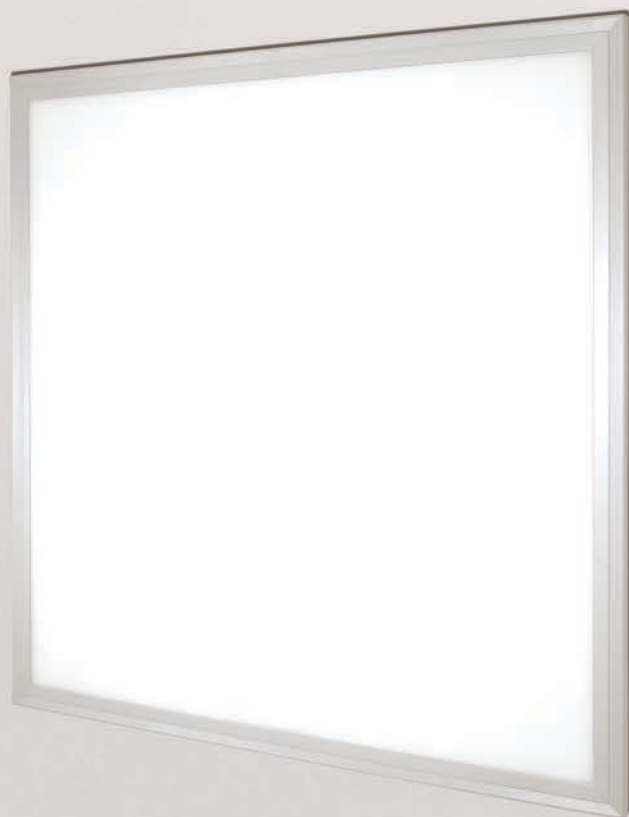
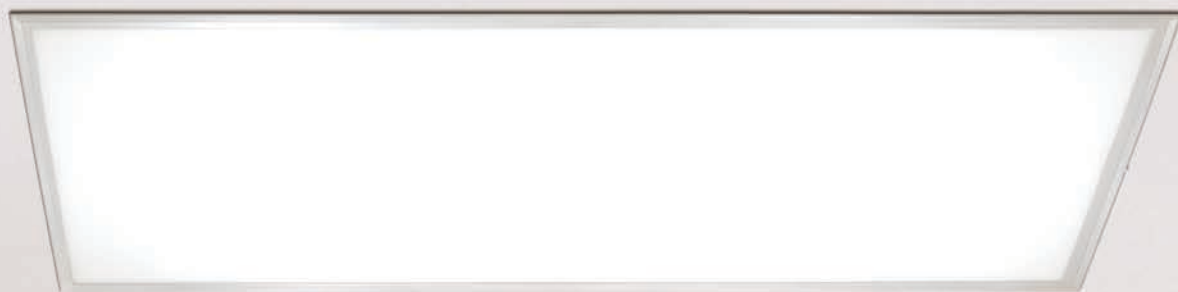

Pannelli LED • LED panels



Standard: for modular ceilings

Molle BPLKITSPRING

Optional: ceiling kit

Part N°: BPLKITCEIL1B

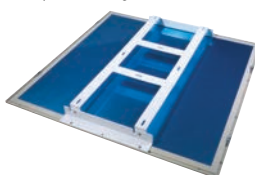

Optional: suspension kit

Part N°: BPLKIT4X150C



Part N°: BPLKITWALLOB



Optional: closed ceiling kit (60x60 only)  
Part N°: BPLKITBOX00B White



Type	Part N°	Dimensions (mm)	Input (V)	Colour	Frame colour	°Kelvin	Lumen	Power (W)	Packing box dimensions (mm)	Weight (kg)
60x60 CW	<b>BPL60600EACW</b>	595x595x10,5h	24 VDC	Cool White	Aluminum	6000°K	4322	42	650x650x40h	4,2
60x60 NW	<b>BPL60600EANW</b>	595x595x10,5h	24 VDC	Natural White	Aluminum	4200°K	4078	42	650x650x40h	4,2
60x60 WW	<b>BPL60600EAWW</b>	595x595x10,5h	24 VDC	Warm White	Aluminum	3000°K	3761	42	650x650x40h	4,2
60x120 NW	<b>BPL60120EANW</b>	1195x595x14h	24 VDC	Natural White	Aluminum	4200°K	6470	85	1350x660x60h	10,5
60x120 WW	<b>BPL60120EAWW</b>	1195x595x14h	24 VDC	Warm White	Aluminum	3000°K	6082	85	1350x660x60h	10,5

## 🇮🇹 Pannello LED 60x60 - 60x120

- Cornice e struttura in alluminio
- Adatto per sostituire incassi standard per tubi fluo
- Grande omogeneità luminosa
- Funziona in bassa tensione con trasformatore 24V DC specifico (fornito a richiesta)
- Consumo limitato

- Luminosité très homogène

- Il marche en basse tension avec un transformateur 24V DC (livré sur demande) - Consommation limitée

## 🇬🇧 LED panel 60x60 - 60x120

- Structure and frame in aluminum
- Suitable for replacing standard fixtures for fluo tubes
- Great homogeneity of light
- Safety low voltage with specific 24V DC drivers (supplied on request)
- Limited consumption

## 🇪🇸 Panel LED 60x60 - 60x120

- Estructura y marco de aluminio
- Adecuado para replazo directo de lampara estandar con tubos de fluorescencia
- Excelente homogeneidad luminica
- Alta seguridad por funcionamiento a baja tension, con drivers especificos de 24VDC (bajo demanda) - Bajo consume

## 🇩🇪 LED-Tafel 60x60 - 60x120

- Rahme und Körper aus Aluminium
- Für direkten Ersatz von standard Leuchtstoffröhren geeignet
- Groß Homogenität des Lichts
- NV-Betrieb durch besonderen 24VDC Transformator (auf Anfrage geliefert)
- Begrenzter Verbrauch

## 🇫🇷 Panneau LED 60x60 - 60x120

- Encadrement et corps en aluminium
- Approprié pour le remplacement des encastrables standard à tubes fluo



Versione DALI disponibile a richiesta  
DALI version available on request

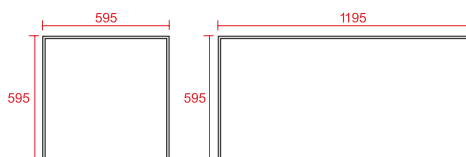

# LED PANEL

30x30 • 30x60 • 30x120

**QUALIKO**  
PROFESSIONAL LIGHT COMPONENTS srl



Pannelli LED • LED panels

# LED PANEL 30x30 • 30x60 • 30x120 Pannelli LED • LED panels **QUALIKO**

Standard: for modular ceilings



Molle BPLKITSRING



Optional: ceiling kit

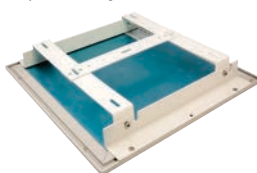

Part N°: BPLKITCEILOB



Optional: suspension kit



Part N°: BPLKIT4X150C



Optional: wall kit



Part N°: BPLKITWALLOB

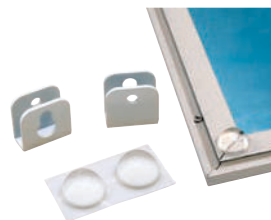

**24 Volt**  
Safety Voltage



Vedere pagina 168 per i kit che includono il driver LED - See page 168 for kits including LED driver

CE III EMC IP52 RoHS

Type	Part N°	Dimensions (mm)	Input (V)	Colour	°Kelvin	Lumen	Power (W)	Packing box dimensions (mm)	Weight (kg)
30x30 CW	<b>BPL30300EACW</b>	295x295x10,5h	24 VDC	Cool White	6000°K	698	10	350x310x40h	1,1
30x30 NW	<b>BPL30300EANW</b>	295x295x10,5h	24 VDC	Natural White	4200°K	659	10	350x310x40h	1,1
30x30 WW	<b>BPL30300EAWW</b>	295x295x10,5h	24 VDC	Warm White	3000°K	619	10	350x310x40h	1,1
30x60 CW	<b>BPL30600EACW</b>	595x295x10,5h	24 VDC	Cool White	6000°K	1550	22	620x350x40h	1,9
30x60 NW	<b>BPL30600EANW</b>	595x295x10,5h	24 VDC	Natural White	4200°K	1450	22	620x350x40h	1,9
30x60 WW	<b>BPL30600EAWW</b>	595x295x10,5h	24 VDC	Warm White	3000°K	1376	22	620x350x40h	1,9
30x120 CW	<b>BPL30120EACW</b>	1195x295x10,5h	24 VDC	Cool White	6000°K	3510	42	1200x350x40h	4,0
30x120 NW	<b>BPL30120EANW</b>	1195x295x10,5h	24 VDC	Natural White	4200°K	3390	42	1200x350x40h	4,0
30x120 WW	<b>BPL30120EAWW</b>	1195x295x10,5h	24 VDC	Warm White	3000°K	3187	42	1200x350x40h	4,0

## 🇮🇹 Pannello LED 30x30 - 30x60 - 30x120

- Cornice e struttura in alluminio
- Adatto per sostituire incassi standard per tubi fluo
- Grande omogeneità luminosa- Spessore 10,5 mm
- Funziona in bassa tensione con trasformatore 24V DC specifico (fornito a richiesta)
- Consumo limitato

## 🇬🇧 LED panel 30x30 - 30x60 - 30x120

- Structure and frame in aluminium
- Suitable for replacing standard fixtures for fluo tubes
- Great homogeneity of light
- Thickness 10,5 mm
- Safety low voltage with specific 24V DC drivers (supplied on request)
- Limited consumption

## 🇩🇪 LED-Tafel 30x30 - 30x60 - 30x120

- Rahme und Körper aus Aluminium
- Für direkten Ersatz von standard Leuchtstoffröhren geeignet
- Groß Homogenität des Lichts- Dicke 10,5 mm
- NV-betrieb durch besonderen 24VDC Transformator (auf Anfrage geliefert)
- Begrenzter Verbrauch

## 🇫🇷 Panneau LED 30x30 - 30x60 - 30x120

- Encadrement et corps en aluminium
- Approprié pour le remplacement des encastrables standard à tubes fluo

- Luminosità très homogène
- Épaisseur 10,5 mm
- Il marche en basse tension avec un transformateur 24V DC (livré sur demande) - Consommation limitée

## 🇪🇸 Panel LED 30x30 - 30x60 - 30x120

- Estructura y marco de aluminio
- Adecuado para remplazo directo de lampara estandar con tubos de fluorescencia
- Excelente homogeneidad luminica
- Grosor 10,5 mm
- Alta seguridad por funcionamiento a baja tension, con drivers especificos de 24VDC (bajo demanda) - Bajo consume

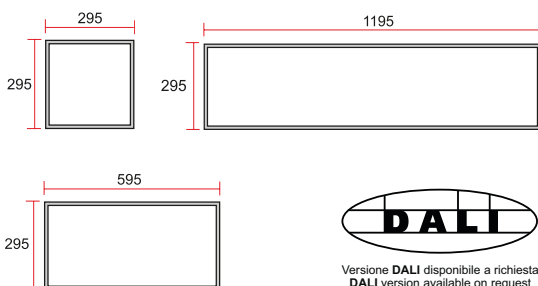

Versione DALI disponibile a richiesta  
DALI version available on request

# FRAMELESS EVO

60x60

QUALIKO<sup>srl</sup>  
PROFESSIONAL LIGHT COMPONENTS



Pannelli LED • LED panels



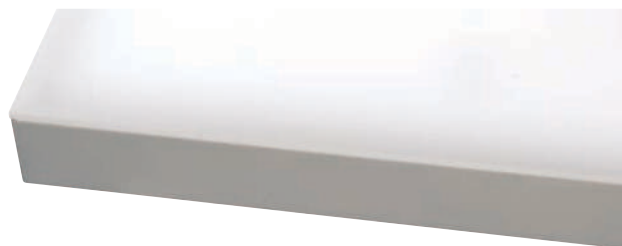

Standard: for modular ceilings



Molle BPLKITSRING



Optional: ceiling kit

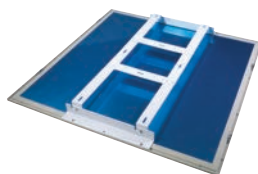

Part N°: BPLKITCEIL1B



Optional: suspension kit

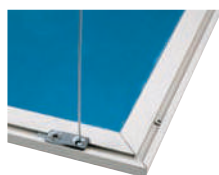

Part N°: BPLKIT4X150C



Optional: wall kit



Part N°: BPLKITWALLOB



Type	Part N°	Dimensions (mm)	Input (V)	Colour	°Kelvin	Lumen	Power (W)	Packing box dimensions (mm)	Weight (kg)
60x60 FRAMELESS DRI CW	<b>BPL6060FRDRC</b>	595x595x18h	200+240	Cool White	6000°K	4322	42	650x650x40h	4,2
60x60 FRAMELESS DRI NW	<b>BPL6060FRDRN</b>	595x595x18h	200+240	Natural White	4200°K	4078	42	650x650x40h	4,2
60x60 FRAMELESS DRI WW	<b>BPL6060FRDRW</b>	595x595x18h	200+240	Warm White	3000°K	3761	42	650x650x40h	4,2

## 🇮🇹 Pannelli FRAMELESS

- Struttura in alluminio senza cornice
- I pannelli si possono affiancare al fine di creare intere pareti senza interruzioni
- Adatto per sostituire incassi standard per tubi fluo
- Grande omogeneità luminosa - Spessore 18 mm
- Funziona in bassa tensione con trasformatore 1A incluso
- Consumo limitato

## 🇬🇧 FRAMELESS panel

- Aluminum body without frame
- Panels can be installed side by side without interruptions
- Suitable for replacing standard fixtures for fluo tubes
- Great homogeneity of light - Thickness 18 mm
- Safety low voltage with 1A drivers included
- Limited consumption

## 🇩🇪 Panele FRAMELESS

- Struktur aus Aluminium ohne Rahme
- Die Led-Panelen können verbunden werden, um ganze Wände ohne Unterbrechung und mit großer Farb- und Helligkeitsverteilung zu erstellen
- Für direkten Ersatz von standard Leuchtstoffröhren geeignet
- Groß Homogenität des Lichts - Dicke 18 mm
- 1A Led-Treiber dabei geliefert
- Begrenzter Verbrauch

## 🇫🇷 Panneaux LED FRAMELESS

- Structure en aluminium sans encadrement
- Les panneaux peuvent être assemblés afin de créer des parois sans interruptions
- Approprié pour le remplacement des encastrables standard à tubes fluo
- Luminosité très homogène - Épaisseur 18 mm
- Il marche en basse tension avec un convertisseur 1A livré avec
- Consommation limitée

## 🇪🇸 Paneles sin marco

- Cuerpo de aluminio sin marco
- Los paneles pueden instalarse uno al lado del otro sin interrupciones
- Adecuado para remplazo directo de lampara estandar con tubos de fluorescencia
- Excelente homogeneidad luminica - Grosor 18 mm
- Alta seguridad por funcionamiento a baja tension, con drivers especificos de 1A (incluido)
- Bajo consumo

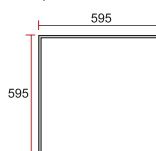

Versione DALI disponibile a richiesta  
DALI version available on request

# PAN HOLE

60x60

QUALIKO  
PROFESSIONAL LIGHT COMPONENTS srl



Cornice LED • LED Frame

# PAN HOLE 60x60 Cornice LED • LED Frame

QUALIKO<sup>®</sup>



Versione DALI disponibile a richiesta  
DALI version available on request



CE EMC IP20 RoHS



Type	Part N°	Dimensions (mm)	Input (V)	Colour	Frame colour	°Kelvin	Lumen	Power (W)	Packing box dimensions (mm)	Weight (kg)
PAN HOLE 60x60 NW	<b>BPLHOLEDRINW</b>	593x593x15h	220÷240	Natural White	Aluminum	4000°K	3200	40	610x55x45h	0,65
PAN HOLE 60x60 WW	<b>BPLHOLEDRIWW</b>	593x593x15h	220÷240	Warm White	Aluminum	3000°K	3200	40	610x55x45h	0,65

## Cornice LED 60x60

- Cornice componibile in quattro parti
- Per utilizzo in controsoffitti modulari standard
- Grande luminosità
- Funziona in bassa tensione con trasformatore 1A incluso
- Consumo limitato

## LED Frame 60x60

- Connectable four parts frame
- Suitable for standard modular counterceilings
- High light flux
- Safety low voltage with 1A drivers included
- Limited consumption

## LED-Rahme 60x60

- 4-teil komponible Led-rame modularen
- Für Verwendung in falschen Decken
- Hone Lichtsausbeute
- 1A Led-Treiber dabei geliefert
- Begrenzter Verbrauch

## Corniche LED 60x60

- Corniche de 4 elements à composer
- Utilisation en faux plafond modulaire standard
- Haute Luminosité
- Il marche en basse tension avec un convertisseur 1A livré avec
- Consommation limitée

## Marco LED 60x60

- Marco modular en 4 partes
- Para utilizar en falsos techos modulares estándar
- Excelente flujo luminoso
- Alta seguridad por funcionamiento a baja tension, con drivers especificos de 1A (incluido)
- Bajo consume

# LED PANEL RGB

QUALIKO<sup>srl</sup>  
PROFESSIONAL LIGHT COMPONENTS



Pannelli LED • LED panels



Vedere pagina 168 per i kit che includono il driver LED - See page 168 for kits including LED driver

Part N°: BPLKITCEILOB for 30x30  
Part N°: BPLKITCEI1B for 60x60 - 60x120

Standard: for modular ceilings



Molle BPLKITSRING



Optional: ceiling kit

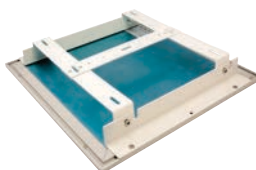

Part N°: BPLKITCEILOB



Optional: suspension kit

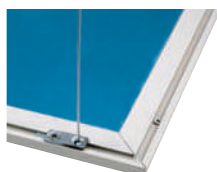

Part N°: BPLKIT4X150C



Optional: wall kit

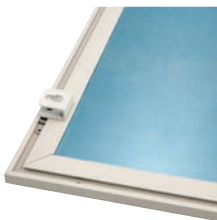

Part N°: BPLKITWALLOB

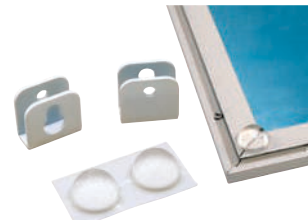

Type	Part N°	Dimensions (mm)	Input (V)	Colour	Power (W)	Packing box dimensions (mm)	Weight (kg)
30x30 RGB	<b>BPL30300EARG</b>	295x295x10,5h	24 VDC	RGB	10	350x310x40h	1,1
60x60 RGB	<b>BPL60600EARG</b>	595x595x10,5h	24 VDC	RGB	42	650x650x30h	4,2
60x120 RGB	<b>BPL60120EARG</b>	1195x595x14h	24 VDC	RGB	55	1350x660x60h	10,5

### Pannello LED RGB

- Cornice e struttura in alluminio
- Adatto per sostituire incassi standard per tubi fluo
- Grande omogeneità luminosa- Spessore 10,5 mm
- Funziona in bassa tensione con driver QLT mod. RBOX424 (fornito a richiesta)
- Consumo limitato: 60x120 55W - 60x60 42W - 30x30 10W

### Panneau LED RGB

- Encadrement et corps en aluminium
- Approprié pour le remplacement des encastrables standard à tubes fluo
- Luminosité très homogène - Épaisseur 10,5 mm
- Il marche en basse tension avec QLT RBOX424 (livré sur demande)
- Consommation limitée: 60x120 55W - 60x60 42W - 30x30 10W

### LED panel RGB

- Structure and frame in aluminum
- Suitable for replacing standard fixtures for fluo tubes
- Great homogeneity of light
- Thickness 10,5 mm
- Safety low voltage with QLT RBOX424 (supplied on request)
- Limited consumption: 60x120 55W - 60x60 42W - 30x30 10W

### Panel LED RGB

- Estructura y marco de aluminio
- Adecuado para remplazo directo de lampara estandar con tubos de fluorescencia
- Excelente homogeneidad luminica
- Grosor 10,5 mm
- Alta seguridad por funcionamiento a baja tension, con drivers QLT RBOX424 (bajo demanda)
- Bajo consume: 60x120 55W - 60x60 42W - 30x30 10W

### LED-Tafel RGB

- Rahme und Körper aus Aluminium
- Für direkten Ersatz von standard Leuchtstoffröhren geeignet
- Groß Homogenität des Lichts
- Dicke 10,5 mm
- NV-betrieb durch besonderen QLT RBOX424 (auf Anfrage geliefert)
- Begrenzter Verbrauch: 60x120 55W - 60x60 42W - 30x30 10W

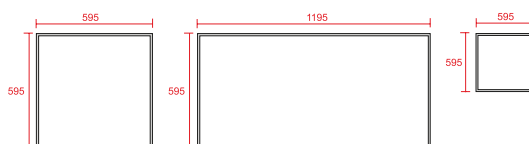

# WALLY

QUALIKO  
PROFESSIONAL LIGHT COMPONENTS  
srl

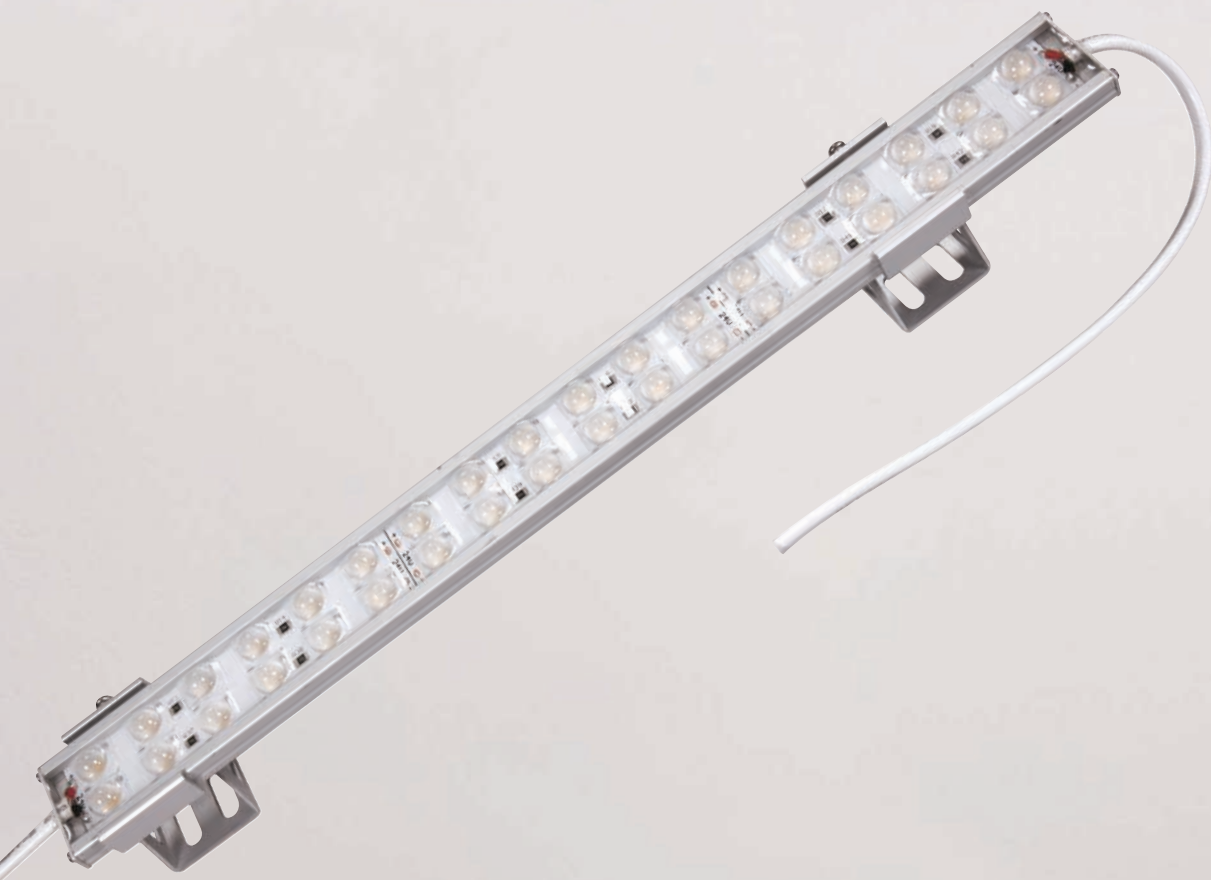

Mini lavamuro LED • Mini LED wall washer



Versione DALI disponibile a richiesta  
DALI version available on request

Vedere pagina 168 per i kit che includono il driver LED - See page 168 for kits including LED driver

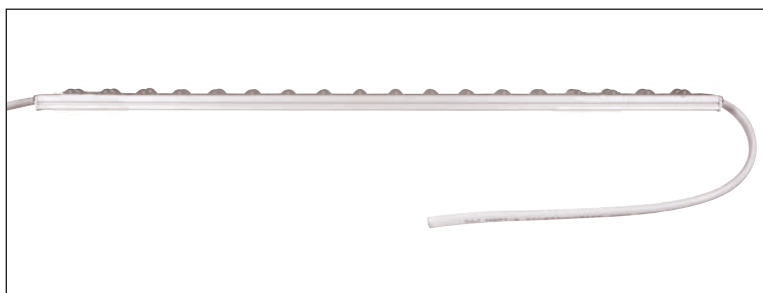

Type	Part N°	Dimensions (mm)	Beam (°)	Input (V)	Power (W)	Flux (Lm)	°Kelvin	Packing box dimensions (mm)	Weight (kg)
WALLY 30 25° NW	<b>BAW225L3009N</b>	300x30x7h	25	24 VDC	9±1	678	4000°	350x37x24	0,25
WALLY 30 25° WW	<b>BAW225L3009W</b>	300x30x7h	25	24 VDC	9±1	594	3000°	350x37x24	0,25
WALLY 30 45° NW	<b>BAW245L3009N</b>	300x30x7h	45	24 VDC	9±1	698	4000°	350x37x24	0,25
WALLY 30 45° WW	<b>BAW245L3009W</b>	300x30x7h	45	24 VDC	9±1	602	3000°	350x37x24	0,25
WALLY 120 25° NW	<b>BAW22512035N</b>	1200x30x7h	25	24 VDC	35±1	2557	4000°	1258x37x24	0,55
WALLY 120 25° WW	<b>BAW22512035W</b>	1200x30x7h	25	24 VDC	35±1	2227	3000°	1258x37x24	0,55
WALLY 120 45° NW	<b>BAW24512035N</b>	1200x30x7h	45	24 VDC	35±1	2574	4000°	1258x37x24	0,55
WALLY 120 45° WW	<b>BAW24512035W</b>	1200x30x7h	45	24 VDC	35±1	2271	3000°	1258x37x24	0,55

**BAW2ROTBRACK** adjustable tilt bracket - 1 piece - optional

### **Proiettore LED lineare per illuminazione radente**

- Adatto all'uso sia interno che esterno (IP65)
- Disponibile con due fasci luminosi: 25° e 45°
- Dimensioni estremamente compatte.
- Staffa ad inclinazione regolabile opzionale.

### **Linear LED wallwasher**

- Suitable for both indoor and outdoor use (IP65)
- Available with two light beams: 25° and 45°
- Extremely compact dimensions
- Optional adjustable tilt bracket

### **Linearer LED-Fluter für Weidebeleuchtung (Wallwasher)**

- Geeignet für den innen- und Außenbereich (IP65)
- Verfügbar mit zwei Lichtstrahlen: 25° und 45°
- Extrem kompakte Abmessungen
- Optionale einstellbare Neigungshalterung

### **Projecteur linéaire à LED pour éclairage rasant (Wallwasher)**

- Approprié pour une utilisation et à l'intérieur (IP65)
- Disponible en deux faisceaux lumineux: 25° et 45°
- Taille super compacte
- Support pour installation orientable (Optional)

### **Proyector lineal LED (bañador de pared)**

- Para uso tanto en interiores como en exteriores (IP65)
- Disponible con dos haces de luz: 25° y 45°
- Dimensiones extremadamente compactas
- Soporte de inclinación ajustable opcional

# WALLY RGB

QUALIKO<sup>srl</sup>  
PROFESSIONAL LIGHT COMPONENTS



Mini lavamuro LED • Mini LED wall washer



# WALLY RGB Mini lavamuro LED • Mini LED wall washer

QUALIKO

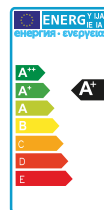

24 Volt  
Safety Voltage



Vedere pagina 168 per i kit che includono il driver LED - See page 168 for kits including LED driver

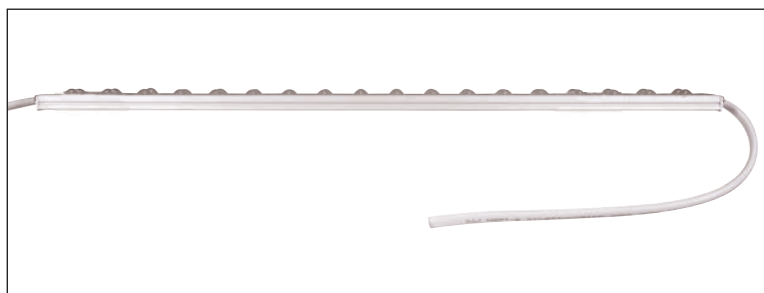

Type	Part N°	Dimensions (mm)	Color	Beam (°)	Input (V)	Power (W)	Flux (Lm)	Packing box dimensions (mm)	Weight (kg)
WALLY 30 25° RGB	<b>BAW225L3009R</b>	300x30x7h	RGB	25	24 VDC	9±1	223	350x37x24	0,25
WALLY 30 45° RGB	<b>BAW245L3009R</b>	300x30x7h	RGB	45	24 VDC	9±1	228	350x37x24	0,25
WALLY 120 25° RGB	<b>BAW22512035R</b>	1200x30x7h	RGB	25	24 VDC	35±1	845	1258x37x24	0,55
WALLY 120 45° RGB	<b>BAW24512035R</b>	1200x30x7h	RGB	45	24 VDC	35±1	866	1258x37x24	0,55
<b>BAW2ROTBRACK</b>		adjustable tilt bracket - 1 piece - optional							

## Proiettore LED RGB lineare per illuminazione radente

- Adatto all'uso sia interno che esterno (IP65)
- Disponibile con due fasci luminosi: 25° e 45°
- Dimensioni estremamente compatte.
- Staffa ad inclinazione regolabile opzionale.

## Linear RGB LED wallwasher

- Suitable for both indoor and outdoor use (IP65)
- Available with two light beams: 25° and 45°
- Extremely compact dimensions
- Optional adjustable tilt bracket

## Linearer RGB LED-Fluter für Weidebeleuchtung (Wallwasher)

- Geeignet für den innen- und Außenbereich (IP65)
- Verfügbar mit zwei Lichtstrahlen: 25° und 45°
- Extrem kompakte Abmessungen
- Optionale einstellbare Neigungshalterung

## Projecteur linéaire à LED RGB pour éclairage rasant (Wallwasher)

- Approprié pour une utilisation et à l'intérieur (IP65)
- Disponible en deux faisceaux lumineux: 25° et 45°
- Taille super compacte
- Support pour installation orientable (Optional)

## Proyector linear LED RGB (bañador de pared)

- Para uso tanto en interiores como en exteriores (IP65)
- Disponible con dos haces de luz: 25° y 45°
- Dimensiones extremadamente compactas
- Soporte de inclinación ajustable opcional

# FLAX EVO

QUALIKO  
PROFESSIONAL LIGHT COMPONENTS  
srl



Plafoniere stagne LED • LED waterproof fixtures



Type	Part N°	Dimensions (mm)	Input (V)	Net weight kg	Flux (Lm)	°Kelvin	Power +/- (W Max)	Power Factor
FLAX EVO 60	<b>BSCWP20620NW</b>	655x80x56h	100÷277	0,70	2587	4000°	20	>0,95
FLAX EVO 120	<b>BSCWP21240NW</b>	1255x80x56h	100÷277	1,25	5175	4000°	40	>0,95
FLAX EVO 150	<b>BSCWP21548NW</b>	1555x80x56h	100÷277	1,53	6298	4000°	48	>0,95

**🇮🇹 Plafoniera stagna LED IP65**

- Sostituisce la tradizionale plafoniera stagna fluorescente
- Schermo in Policarbonato.
- Applicazioni tipiche: uffici, aree produttive, supermercati, laboratori, etc.
- CRI>80

**🇬🇧 LED waterproof IP65 fitting**

- Ideal replacement for traditional fluo waterproof fitting
- Polycarbonate cover.
- Typical applications: offices, manufacturing areas, supermarkets, laboratories, etc.
- CRI>80

**🇩🇪 IP65 wassergedichte Led-Leuchte**

- Für Ersatz von Standard wassergedichten Leuchtstofflampen geeignet
- Schirm aus Polycarbonat.
- Typische Anwendungen: Büros, Industriegebieten, Labors, Supermärkten usw
- CRI>80

**🇫🇷 Plafonnier étanche à LED IP65**

- Remplace le plafonnier étanche avec fluorescence
- Reflecteur en polycarbonate.
- Utilisations typiques: bureaux, usines, supermarchés, laboratoires
- CRI>80

**🇪🇸 Luminarias estancas LED IP65**

- Ideal para reemplazar luminarias estancas fluorescentes
- Pantalla de Policarbonato.
- Instalaciones típicas: oficinas, fábricas, supermercados, laboratorios, etc.
- CRI>80



Plafoniere stagne LED • LED waterproof fixtures



**For T8 LED tubes ONE SIDE INPUT ONLY (NOT INCLUDED)**



IP65 IK08 RoHS



Type	Part N°	Dimensions (mm)	Net weight kg	Suggested LED tube (one side input)	Packing Unit (pcs)	Packing unit dimensions (mm)	Packing unit weight Gross (kg)
FUTURA 60	<b>BS1X0600000B</b>	655x90x90h	0,8	1x60 cm	10	680x190x350h	10,0
FUTURA 120	<b>BS1X1200000B</b>	1265x90x90h	1,5	1x120 cm	6	1290x190x220h	8,1
FUTURA 150	<b>BS1X1500000B</b>	1565x90x90h	1,8	1x150 cm	6	1590x190x220h	13,0
FUTURA TWIN 60	<b>BS2X0600000B</b>	655x125x90h	1,0	2x60 cm	8	680x270x280h	10,6
FUTURA TWIN 120	<b>BS2X1200000B</b>	1265x125x90h	2,0	2x120 cm	6	1290x210x270h	13,0
FUTURA TWIN 150	<b>BS2X1500000B</b>	1565x125x90h	2,4	2x150 cm	6	1590x210x270h	17,4

**🇮🇹 Plafoniera stagna LED IP65 per tubi LED**

- Per utilizzo esclusivo con tubi elettronici a LED alimentati su di un solo lato
- Sostituisce la tradizionale plafoniera stagna fluorescente
- Schermo in Policarbonato, clips di chiusura INOX
- Applicazioni tipiche: uffici, aree produttive, supermercati, laboratori, etc.

**🇬🇧 LED tube waterproof IP65 fitting**

- To be used with LED electronic tubes with single side input only
- Ideal replacement for traditional fluo waterproof fitting
- Polycarbonate cover, closing clips in stainless steel
- Typical applications: offices, manufacturing areas, supermarkets, laboratories, etc.

**🇩🇪 IP65 wassergedichte Led-Leuchte**

- Nur mit Led-Leuchten mit einseitiger speisung verwenden
- Für Ersatz von Standard wassergedichten Leuchtstofflampen geeignet
- Schirm aus Polycarbonat und Verschlussklammern aus Edelstahl
- Typische Anwendungen: Büros, Industriegebieten, Labors, Supermärkten usw

**🇫🇷 Plafonnier étanche à LED IP65 pour tubes a LED**

- Utilisation qu'avec des tubes électroniques a LED alimentés d'une seule côté
- Remplace le plafonnier étanche avec fluorescence
- Reflecteur en polycarbonate, clips de fermeture en INOX
- Utilisations typiques: bureaux, usines, supermarchés, laboratoires

**🇪🇸 Luminarias estancas para tubos LED IP65**

- Use sólo tubos electrónicos de LED alimentados en un solo lado
- Ideal para reemplazar luminarias estancas fluorescentes
- Pantalla de Policarbonato, clips de acero inoxidable
- Instalaciones típicas: oficinas, fábricas, supermercados, laboratorios, etc.

# ZERO

QUALIKO<sup>srl</sup>  
PROFESSIONAL LIGHT COMPONENTS



Plafoniere LED • LED fixtures

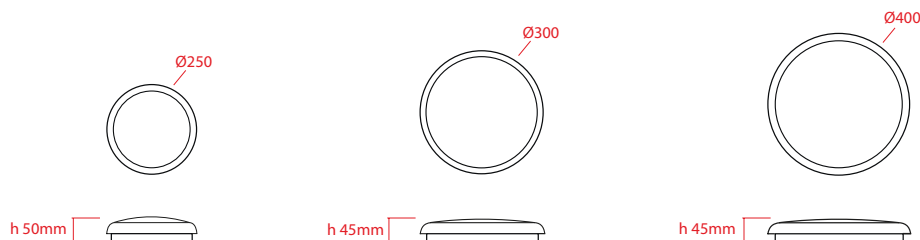

Type	Part N°	Dimensions (mm)	Light Colour	° Kelvin (±10%)	Lumen	Power (W)	Input (V)	CRI	IP	Packing box dimensions (mm)	Weight (kg)
ZERO 25 NW	<b>BZERO25012NW</b>	Ø250	NW	4100°K	1043	12	100÷240 AC	>85	54	260x260x60	0,80
ZERO 30 NW	<b>BZERO30025NW</b>	Ø300	NW	4100°K	2287	25	100÷240 AC	>85	54	310x310x55	1,15
ZERO 40 NW	<b>BZERO40030NW</b>	Ø400	NW	4100°K	2674	30	100÷240 AC	>85	54	410x410x60	1,75
ZERO 25 WW	<b>BZERO25012WW</b>	Ø250	WW	3000°K	982	12	100÷240 AC	>85	54	260x260x60	0,80
ZERO 30 WW	<b>BZERO30025WW</b>	Ø300	WW	3000°K	2276	25	100÷240 AC	>85	54	310x310x55	1,15
ZERO 40 WW	<b>BZERO40030WW</b>	Ø400	WW	3000°K	2348	30	100÷240 AC	>85	54	410x410x60	1,75

**Plafoniera LED per uso esterno IP54**

- Struttura in Policarbonato bianco e schermo in PMMA
- Grande omogeneità luminosa
- Funziona in bassa tensione con trasformatore incorporato
- Consumo molto limitato
- Lunga durata

**IP54 LED fixture for outdoor use**

- Structure and frame in Polycarbonate, PMMA screen
- Homogeneous light output
- Safety low voltage with specific included driver
- Limited consumption
- Long life time

**LED Anbau-Leuchte für Außeninstallation IP54**

- Struktur in weißem Polycarbonat und PMMA Bildschirm
- Homogenes Licht
- NV-Betrieb durch besonderen Transformator
- Begrenzter Verbrauch
- Lange Lebensdauer

**Plafonniers LED pour l'extérieur IP54**

- Corps en Polycarbonate blanc et reflecteur en PMMA
- Luminosité très homogène
- Il marche en basse tension avec alimentation intégrée
- Consommation très limitée
- Longue durée de vie

**Lamparas de techo/pared LED IP54**

- Estructura de policarbonado blanco y pantalla en PMMA
- Excelente homogeneidad luminica
- Alta seguridad por funcionamiento a baja tension, con transformador integrado
- Consumo muy limitado
- Larga vida





Plafoniere LED • LED fixtures



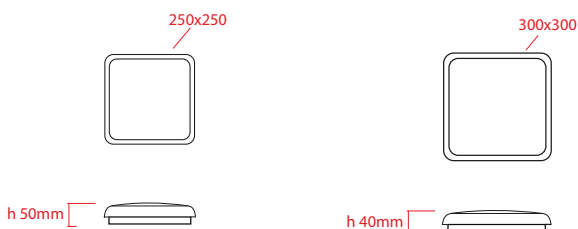

Type	Part N°	Dimensions (mm)	Light Colour	° Kelvin (±10%)	Lumen	Power (W)	Input (V)	CRI	IP	Packing box dimensions (mm)	Weight (kg)
JAZZ 25 NW	<b>BJAZZQ2512NW</b>	250x250	NW	4200°K	1100	12	100÷240 AC	>85	54	260x260x60	0,90
JAZZ 30 NW	<b>BJAZZQ3025NW</b>	300x300	NW	4200°K	2062	25	100÷240 AC	>85	54	310x310x60	1,23
JAZZ 25 WW	<b>BJAZZQ2512WW</b>	250x250	WW	3000°K	1200	12	100÷240 AC	>85	54	260x260x60	0,90
JAZZ 30 WW	<b>BJAZZQ3025WW</b>	300x300	WW	3000°K	1938	25	100÷240 AC	>85	54	310x310x60	1,23

**🇮🇹 Plafoniera LED per uso esterno IP54**

- Struttura in Policarbonato bianco e schermo in PMMA
- Grande omogeneità luminosa
- Funziona in bassa tensione con trasformatore incorporato
- Consumo molto limitato
- Lunga durata

**🇬🇧 IP54 LED fixture for outdoor use**

- Structure and frame in Polycarbonate, PMMA screen
- Homogeneous light output
- Safety low voltage with specific included driver
- Limited consumption
- Long life time

**🇩🇪 LED Anbau-Leuchte für Außeninstallation IP54**

- Struktur in weißem Polycarbonat und PMMA Bildschirm
- Homogenes Licht
- NV-Betrieb durch besonderen Transformator
- Begrenzter Verbrauch
- Lange Lebensdauer

**🇫🇷 Plafonniers LED pour l'extérieur IP54**

- Corps en Polycarbonate blanc et réflecteur en PMMA
- Luminosité très homogène
- Il marche en basse tension avec alimentation intégrée
- Consommation très limitée
- Longue durée de vie

**🇪🇸 Lamparas de techo/pared LED IP54**

- Estructura de policarbonado blanco y pantalla en PMMA
- Excelente homogeneidad luminica
- Alta seguridad por funcionamiento a baja tension, con transformador integrado
- Consumo muy limitado
- Larga vida



# BILLY CCT

QUALIKO<sup>srl</sup>  
PROFESSIONAL LIGHT COMPONENTS



Plafoniere LED • LED fixtures

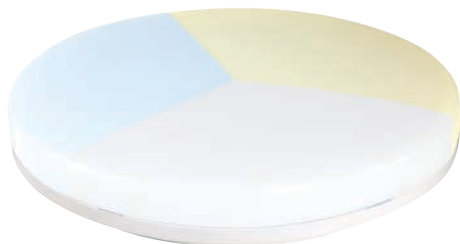

CE EMC IP54 IK08 RoHS

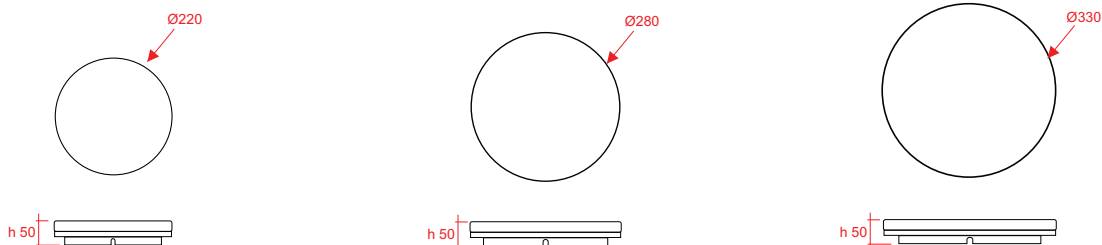

Type	Part N°	Dimensions (mm)	° Kelvin (±10%)	Lumen	Power (W)	Input (V)	CRI	IP	Packing box dimensions (mm)	Weight (kg)
BILLY 12 CCT	<b>BCL120112CCT</b>	Ø220x50h	3000 - 4000 - 5700K	1490	12±1	175÷240 AC	>80	IP54	225x225x55h	0,45
BILLY 18 CCT	<b>BCL120118CCT</b>	Ø280x50h	3000 - 4000 - 5700K	2150	18±1	175÷240 AC	>80	IP54	285x285x55h	0,73
BILLY 24 CCT	<b>BCL120124CCT</b>	Ø330x50h	3000 - 4000 - 5700K	3200	24±1	175÷240 AC	>80	IP54	335x335x55h	0,98

**Plafoniere LED CCT**

- Selettore per scelta colore (3000K - 4000K - 5700K)
- Struttura in Policarbonato bianco e schermo in PMMA
- Grande omogeneità luminosa
- Funziona in bassa tensione con trasformatore incorporato
- Consumo molto limitato
- Lunga durata

**CCT LED Fixture**

- Switch for color setting (3000K - 4000K - 5700K)
- Structure and frame in Polycarbonate, PMMA screen
- Homogeneous light output
- Safety low voltage with specific included driver
- Limited consumption
- Long life time

**Led Anbau-Leuchte CCT**

- Switch für Farbauswahl (3000K - 4000K - 5700K)
- Struktur in weißem Polycarbonat und PMMA Bildschirm
- Homogenes Licht
- NV-Betrieb durch besonderen Transformator
- Begrenzter Verbrauch
- Lange Lebensdauer

**Plafonniers LED CCT**

- Programmeur de teintes (3000K - 4000K - 5700K)
- Corps en Polycarbonate blanc et réflecteur en PMMA
- Luminosité très homogène
- Il marche en basse tension avec alimentation intégrée
- Consommation très limitée
- Longue durée de vie

**Lamparas de techo/pared LED CCT**

- Selector de colores (3000K - 4000K - 5700K)
- Estructura de policarbonado blanco y pantalla en PMMA
- Excelente homogeneidad luminica
- Alta seguridad por funcionamiento a baja tension, con transformador integrado
- Consumo muy limitado
- Larga vida

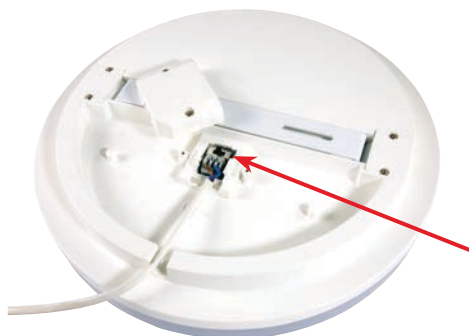

- 3000K
- 4000K
- 5700K



Plafoniere LED • LED fixtures



CE EMC IP65 IK08 RoHS

Type	Part N°	Dimensions (mm)	Light Colour	° Kelvin (±10%)	Lumen	Power (W)	Input (V)	CRI	IP	Weight (kg)
PIXY ROUND 12	BPIXY12RO40B	Ø 190x80h	NW	4000°K	960	12±1	220÷240 AC	>80	IP65	0,25
PIXY OVAL 12	BPIXY12OV40B	216x118x79h	NW	4000°K	960	12±1	220÷240 AC	>80	IP65	0,25

**Plafoniera LED IP65**

- Struttura in Policarbonato bianco e schermo in PMMA
- Grande omogeneità luminosa
- Funziona in bassa tensione con trasformatore incorporato
- Consumo molto limitato
- Lunga durata

**IP65 LED fixture**

- Structure and frame in Polycarbonate, PMMA screen
- Homogeneous light output
- Safety low voltage with specific included driver
- Limited consumption
- Long life time

**LED Anbau-Leuchte IP65**

- Struktur in weißem Polycarbonat und PMMA Bildschirm
- Homogenes Licht
- NV-Betrieb durch besonderen Transformator
- Begrenzter Verbrauch
- Lange Lebensdauer

**Plafonniers LED IP65**

- Corps en Polycarbonate blanc et reflecteur en PMMA
- Luminosité très homogène
- Il marche en basse tension avec alimentation intégrée
- Consommation très limitée
- Longue durée de vie

**Lamparas de techo/pared LED IP65**

- Estructura de policarbonado blanco y pantalla en PMMA
- Excelente homogeneidad luminica
- Alta seguridad por funcionamiento a baja tension, con transformador integrado
- Consumo muy limitado
- Larga vida



Plafoniere LED • LED fixtures

Made in Italy



CE EMC IP52 RoHS

Type	Part N°	Dimensions (mm)	Light Colour	° Kelvin (±10%)	Lumen	Power (W)	Input (V)	P.F.	CRI	Packing box dimensions (mm)	Weight (kg)
ZEUS Small NW	<b>BPC130CCTNW</b>	Ø130x105h	NW	4200°K	835	11	100÷240 AC	>0,60	>80	130x130x120h	0,55
ZEUS Med NW	<b>BPC165CCTNW</b>	Ø165x120h	NW	4200°K	1623	20	100÷240 AC	>0,85	>80	180x180x130h	0,85
ZEUS Large NW	<b>BPC200CCTNW</b>	Ø200x130h	NW	4200°K	2344	29	100÷240 AC	>0,93	>80	210x210x140h	1,25
ZEUS Small WW	<b>BPC130CCTWW</b>	Ø130x105h	WW	3000°K	785	11	100÷240 AC	>0,60	>80	130x130x120h	0,55
ZEUS Med WW	<b>BPC165CCTWW</b>	Ø165x120h	WW	3000°K	1525	20	100÷240 AC	>0,85	>80	180x180x130h	0,85
ZEUS Large WW	<b>BPC200CCTWW</b>	Ø200x130h	WW	3000°K	2203	29	100÷240 AC	>0,93	>80	210x210x140h	1,25

## Plafoniera LED

- Struttura in alluminio verniciato
- Grande omogeneità luminosa
- Funziona in bassa tensione con trasformatore incorporato
- Consumo molto limitato
- Lunga durata

## LED ceiling fixture

- Painted aluminum structure
- Homogeneous light output
- Safety low voltage with specific included driver
- Limited consumption
- Long life time

## LED Anbau-Leuchte

- Structure en aluminium vernis
- Luminosité très homogène
- Il marche en basse tension avec alimentation intégrée
- Consommation tres limitée
- Longue durée de vie

## Plafonniers LED

- Corps en Polycarbonate blanc et reflecteur en PMMA
- Luminosité très homogène
- Il marche en basse tension avec alimentation intégrée
- Consommation tres limitée
- Longue durée de vie

## Lamparas de techo/pared LED

- Estructura de aluminio pintado
- Excelente homogeneidad luminica
- Alta seguridad por funcionamiento a baja tension, con transformador integrado
- Consumo muy limitado
- Larga vida

# HIGH BAY EVO3

QUALIKO<sup>srl</sup>  
PROFESSIONAL LIGHT COMPONENTS



Campane LED • LED High Bay





CE EMC IK08 IP65 RoHS



Inclination micro adjustment



Optional: Installation bracket Part N°: BCBRACKEVO2N  
Optional: Installation bracket Part N°: BCBRACKEVO3N



Type	Part N°	Dimensions (mm)	Input V	Weight kg	Flux (Lm)	° Kelvin	Power (W max)	Beam	CRI
HB EVO2 100	BC100EV2040N	Ø 338x165h	200÷240	4,50	12950	4000°K	100	110°	>80
HB EVO3 150	BC150FPSEV3N	Ø 299x139h	100÷277	2,85	22000	4000°K	150	90°	>80
HB EVO3 200	BC200FPSEV3N	Ø 347x142h	100÷277	4,00	28800	4000°K	200	90°	>80

### 🇮🇹 Campana a LED IP65

- LED ad alta efficienza Lumileds
- Power Factor > 0,95
- Temperatura ambiente operativa -40°C÷+60°C
- Assenza di UV, IR, mercurio e sodio
- Accensione istantanea
- Applicazioni tipiche: magazzini, aree produttive, supermercati, palestre, lavorazione cibi, celle frigorifere, etc.

### 🇬🇧 High power IP65 LED High Bay

- Lumileds high efficiency LED
- Power factor >0,95- No UV, IR, mercury or sodium
- Operating temperature -40°C÷+60°C
- Instant ON-OFF
- Typical applications: warehouse, manufacturing, floodlighting, gymnasium, food processing, cold storage, etc.

### 🇩🇪 High power LED High Bay IP65

- High Brightness LED Lumileds
- Leistungsfaktor: >0,95
- Betriebstemperatur: -40°C÷+60°C
- Abwesenheit von UV, IR, Quecksilber und Natrium
- Sofortanschaltung
- Typische Anwendungen: Lagerhallen, Produktionsstätten, Supermärkten, Fitness Centre, Lebensmittelverarbeitung, Kühlhaus usw.

### 🇫🇷 Suspension à LED haute efficacité IP65

- Facteur de puissance > 0,95 - LED Lumileds
- Absence de UV, IR, mercure et sodium
- Température ambiante de fonctionnement -40°C÷+60°C
- Allumage immédiate
- Applications: magasins, usines, supermarchés, gymnases, chambres frigorifiques, etc.

### 🇪🇸 Campanas industriales con LED de alta potencia IP65

- Led Lumileds de alta eficiencia
- Factor de potencia > 0,95
- Temperatura de funcionamiento -40°C÷+60°C
- No UV, IR, Mercurio o sodio
- Encendido y apagado instantáneo
- Aplicaciones típicas: Almacenes, fábricas, supermercados, gimnasios, almacenes de frío, etc.



# GIANT EVO

QUALIKO<sup>srl</sup>  
PROFESSIONAL LIGHT COMPONENTS



Proiettori LED • LED floods



Type	Part N°	Dimensions (mm)	Weight kg	Flux (lm)	°Kelvin	Input Voltage (V)	Power Max (W)	Power Factor	Packing box Dimensions (mm)
GIANT EVO 60	<b>BFL060EVO40G</b>	325x90x90h	3,20	6932	4000°	200÷240	60	>0,95	430x270x150
GIANT EVO 120	<b>BFL120EVO40G</b>	325x90x170h	4,70	15605	4000°	200÷240	120	>0,95	430x270x240
GIANT EVO 180	<b>BFL180EVO40G</b>	325x90x250h	5,60	20142	4000°	200÷240	180	>0,95	430x340x330
GIANT EVO 240	<b>BFL240EVO40G</b>	325x90x330h	6,70	26376	4000°	200÷240	240	>0,95	475x430x210
GIANT EVO 300	<b>BFL300EVO40G</b>	325x90x410h	8,40	34710	4000°	200÷240	300	>0,95	615x430x210

\*Standard a stock fascio 90°. Disponibili a richiesta fasci 60° o 40° (non a stock)

\*Standard on stock beam 90°. Available on request beam 60° or 40° (not on stock)

## Proiettore LED

- Proiettore orientabile led alta potenza
- Luxeon 3030 LED
- Involucro IP65 - Fascio luminoso 90° standard
- Temperatura ambiente operativa -40°C÷+50°C
- Per uso professionale
- CRI >80

## LED flood

- Adjustable LED high power flood
- Luxeon 3030 LED
- IP65 enclosure - Light beam 90° standard
- Operating temperature -40°C÷+50°C
- For professional use
- CRI >80

## LED-Projektor

- Einstellbar High Brightness LED-Projektor
- Luxeon 3030 LED
- IP65 - Standard Ausstrahlwinkel 90°
- Betriebstemperatur: -40°C÷+50°C
- Nur für berufliche Anwendung
- CRI >80

## Projecteur LED

- Projecteur orientable led à haute puissance
- Luxeon 3030 LED
- IP65 - Faisceau 90° standard
- Température ambiante de fonctionnement -40°C÷+50°C
- Usage professionnel
- CRI >80

## Projector LED

- Projector LED ajustable de alta potencia
- Luxeon 3030 LED
- Caja IP65 - Haz luminoso 90° estandar
- Temperatura de funcionamiento -40°C÷+50°C
- Para uso profesional
- CRI >80

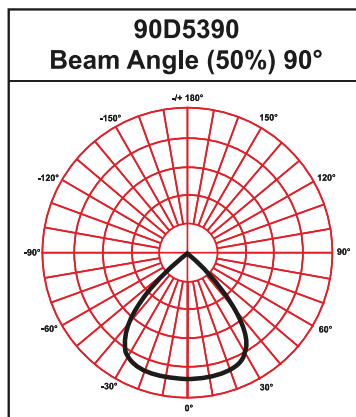

STANDARD

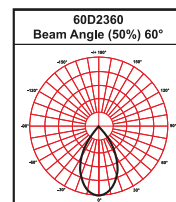
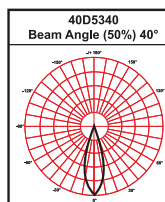

ON REQUEST





Proiettori LED • LED floods



**KANSAS 80**  
8872 Lumen

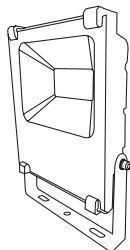

**KANSAS 50**  
5736 Lumen

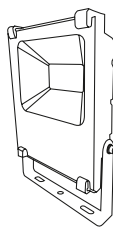

**KANSAS 30**  
3397 Lumen

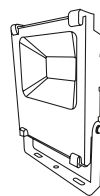

**KANSAS 10**  
750 Lumen

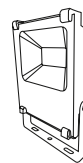

Type	Part N°	Dimensions (mm)	Weight kg	Flux (lm)	°Kelvin	Input Voltage (V)	Power (W max)	Power Factor	Packing box dimensions (mm)
KANSAS 10	<b>BFXTO110400N</b>	130x110x50h	0,51	750	4000°	200±240	10	>0,9	180x135x55h
KANSAS 30	<b>BFXTO330400N</b>	175x156x56h	1,00	3397	4000°	200±240	30	>0,9	280x180x90h
KANSAS 50	<b>BFXTO550400N</b>	235x200x66h	1,93	5736	4000°	200±240	50	>0,9	310x240x75h
KANSAS 80	<b>BFXTO880400N</b>	285x250x69h	2,90	8872	4000°	200±240	80	>0,9	370x280x110h

**Proiettore LED**

- Proiettore orientabile led alta potenza
- Alimentazione 200÷240V-AC 50÷60Hz
- Involucro IP65 verniciato con epossidica nera
- Temperatura ambiente operativa -20°C ÷ +50C°
- Per uso professionale
- CRI >80

**LED flood**

- Adjustable LED high power projector
- Power supply 200÷240V AC 50-60Hz
- IP65 enclosure painted with black epoxy
- Operating temperature -20°C ÷ +50C°
- For professional use
- CRI >80

**LED-Projektor**

- Einstellbar High Brightness LED-Projektor
- Eingang: 200÷240VAC 50÷60Hz
- Schwarz Epoxy lackierte Gehäuse - IP65
- Betriebstemperatur: -20°C ÷ +50C°
- Nur für berufliche Anwendung
- CRI >80

**Projecteur LED**

- Projecteur orientable Led à haute puissance
- Alimentation 200÷240V-AC 50÷60Hz
- Finition avec du vernis epoxy noir - IP65
- Température ambiante de fonctionnement -20°C ÷ +50C°
- Usage professionnel
- CRI >80

**Proyector LED**

- Proyector ajustable de alta potencia
- Fuente de alimentación de 200÷240V AC 50-60Hz
- Caja IP65 pintada con epoxi negro
- Temperatura de funcionamiento -20°C ÷ +50C°
- Para uso profesional
- CRI >80



Proiettori LED • LED floods



**SLIM EVO 10**  
**864 Lumen**

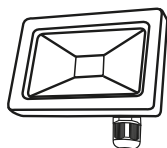

**SLIM EVO 30**  
**2448 Lumen**

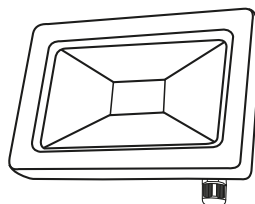

Type	Part N°	Dimensions	Weight kg	Lumen	*Kelvin	Input Voltage (V)	Power (W max)	Power Factor	Packing box Dimensions (mm)
SLIM EVO 10 White	<b>BFL101EVO10B</b>	113xx81x35	0,31	864	4000	200+240	10	>0,9	131x123x40
SLIM EVO 30 White	<b>BFL101EVO30B</b>	185x135x35	0,75	2448	4000	200+240	30	>0,9	203x170x40

**Proiettore LED**

- Proiettore orientabile LED ad alta luminosità
- Nuovo design semplice, pulito, discreto. Adatto anche per usi interni
- Scocca in alluminio pressofuso, colore bianco
- Grado di protezione IP65
- CRI >80

**LED Flood**

- High flux LED Flood
- New clean minimal design. Suitable both for indoor and outdoor
- IP 65 die cast aluminium body, painted in white epoxy
- CRI >80

**LED-Projektor**

- High Power schwenkbar Projektor
- Neu und klares Design - Auch für Inneninstallation geeignet
- Gussaluminiumkörper, Weiss
- Schutzgrad IP 65
- CRI >80

**Projecteur LED**

- Projecteur orientable LED haute luminosité
- Nouveau design simple, net, discret.
- Adapté également à l'usage interne
- Corps en aluminium moulé sous pression, disponible en blanc
- Degré de protection IP65
- CRI >80

**Proyector LED**

- Proyector LED de alto flujo lumínico
- Nuevo diseño sencillo y minimalista. Apropriado para aplicaciones

de interior o exterior

- Cuerpo en aluminio fundido IP65, acabado en pintura epoxy blanco
- CRI >80



# ALASKA EVO

QUALIKO<sup>srl</sup>  
PROFESSIONAL LIGHT COMPONENTS



Lampioni LED • LED Street Lights





Type	Part N°	Dimensions (mm)	Weight kg	Input (V)	Flux (Lm)	°Kelvin	Power (W max)	Surge protection	Pole Ø (mm)	Packing box dimensions (mm)	Packing box Weight (kg)
ALASKA EVO 40	<b>BLT107EVO40G</b>	414X125x90h	1,9	100÷240	5152 Lm	4000°	40	15KV	45+67	460x230x140	2,3

### LED street light

- Lampione stradale a Led asse orizzontale
- Power factor >0,95
- Involucro IP67 verniciato con epossidica grigia
- Temperatura ambiente operativa -40°C ÷ +50°C

### LED street light

- Led street light horizontal axis
- Power factor >0,95- IP67 case and epoxy grey painting
- Working range: -40°C ÷ +50°C

### Street light LED

- Led Straßenleuchte auf horizontale Achse
- Leistungsfaktor: >0,95
- Graue Epoxy-Lackierung – IP67
- Betriebstemperatur: -40°C ÷ +50°C

### LED street light

- Lampadaire à Led axe horizontal
- Facteur de puissance: >0,95
- Finition avec du vernis epoxy gris – IP67
- Température de fonctionnement: -40°C ÷ +50°C

### LED street light

- Alumbrado public Led, eje horizontal
- Factor de potencia: >0,95
- Caja IP67 y pintura de epoxy gris
- Temperatura de funcionamiento: -40°C ÷ +50°C

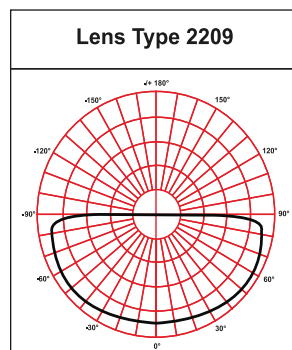
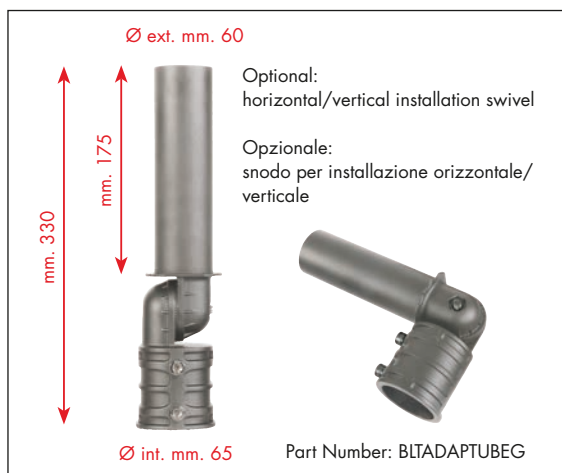

# TEXAS EVO

QUALIKO<sup>srl</sup>  
PROFESSIONAL LIGHT COMPONENTS



Lampioni LED • LED Street Lights



Type	Part N°	Dimensions (mm)	Weight kg	Input (V)	Flux (Lm)	*Kelvin	Power (W max)	Surge protection	Pole Ø (mm)	Packing box dimensions (mm)	Packing box Weight (kg)
TEXAS EVO 60	<b>BLT111EVO40G</b>	435X190x80h	2,7	100÷240	6483 Lm	4000°	60	15KV	57±63	490x260x150	3,30

### LED street light

- Lampione stradale a Led asse orizzontale
- Power factor >0,95
- Involucro IP67 verniciato con epossidica grigia
- Temperatura ambiente operativa -40°C ÷ +50°C

### LED street light

- Led street light horizontal axis
- Power factor >0,95- IP67 case and epoxy grey painting
- Working range: -40°C ÷ +50°C

### Street light LED

- Led Straßenleuchte auf horizontale Achse
- Leistungsfaktor: >0,95
- Graue Epoxy-Lackierung – IP67
- Betriebstemperatur: -40°C ÷ +50°C

### LED street light

- Lampadaire à Led axe horizontal
- Facteur de puissance: >0,95
- Finition avec du vernis epoxy gris – IP67
- Température de fonctionnement: -40°C ÷ +50°C

### LED street light

- Alumbrado public Led, eje horizontal
- Factor de potencia: >0,95
- Caja IP67 y pintura de epoxy gris
- Temperatura de funcionamiento: -40°C ÷ +50°C

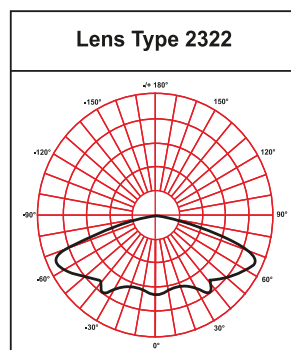
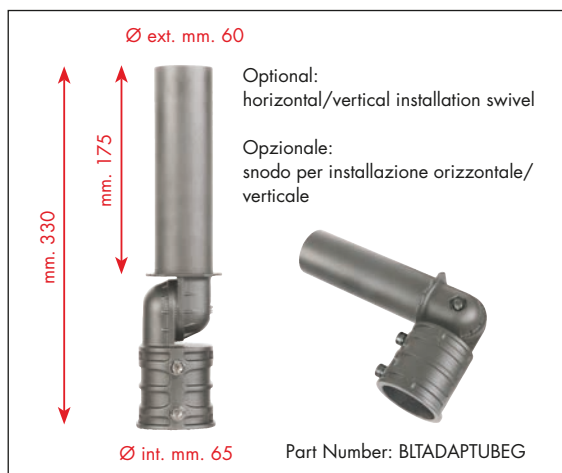

# SWING

QUALIKO<sup>srl</sup>  
PROFESSIONAL LIGHT COMPONENTS



Spot LED orientabile • Adjustable LED ceiling spot



Vedere pagina 168 per i kit che includono la lampadina LED - See page 168 for kits including LED lamp



Type	Part N°	Dimensions (mm)	Standard	Colour	Packing box dimensions (mm)	Packing box weight (kg)
SWING BLACK	<b>BJ1402050T1N</b>	Ø57,5x190h	MR16	Black	100x75x255h	0,46
SWING WHITE	<b>BJ1402050T1B</b>	Ø57,5x190h	MR16	White	100x75x255h	0,46

- Spot LED Orientabile**
- Struttura in alluminio – Colore bianco o nero
  - Orientabile su due assi
  - Installazione a parete o plafone
  - Portalampada GU10 incluso

- Adjustable LED spot**
- Aluminum structure - White or black color
  - Adjustable on two axes
  - Wall or ceiling installation
  - GU10 lamp holder included

- Einstellbarer LED-Spot**
- Aluminiumstruktur - Weiße oder schwarze Farbe
  - Einstellbar auf zwei Achsen
  - Wand- oder Deckenmontage
  - GU10 Lampenfassung enthalten

- Spot à LED orientable**
- Corps en aluminium – Couleur blanche ou noire
  - Orientable sur deux axes
  - Fixation sur le mur ou au plafond
  - Équipé de douille GU10

- Punto LED ajustable**
- Estructura de aluminio - Color blanco o negro
  - Ajustable en dos ejes.
  - Instalación en pared o techo
  - Portalámparas GU10 incluido

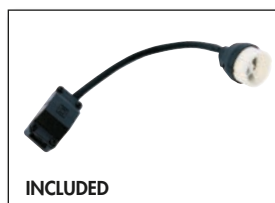
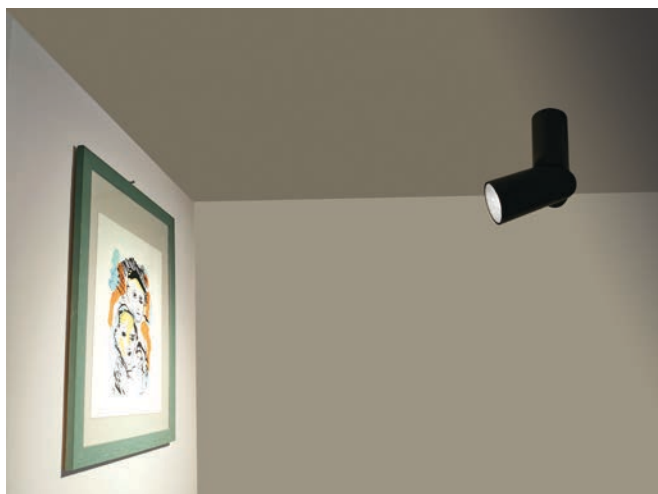



Incassi Alluminio • Aluminium fixtures



Type	Part N°	Dimensions (mm)	Standard	Colour	 (mm)	Packing box dimensions (mm)	Packing box weight (kg)
GLAM SQUARE	<b>B15010150Q1B</b>	82x82x35h	MR16	White	70x70	115x95x65h	0,160
GLAM ROUND	<b>B15010950T1B</b>	Ø82x35h	MR16	White	Ø70	115x95x65h	0,160
GLAM ROUND	<b>B15010950T1N</b>	Ø82x35h	MR16	Black	Ø70	115x95x65h	0,160

Vedere pagina 168 per i kit che includono la lampadina LED - See page 168 for kits including LED lamp

 **Faretti per incasso in Alluminio (per Moduli LED)**

- Corpo in alluminio
- Fonte luminosa arretrata anti-abbagliamento
- Per utilizzo in controsoffitti, fissaggio con molle

 **Recessed Aluminium light fixtures (for LED Modules)**

- Aluminium body
- Recessed light source - No dazzle
- To be used in counter ceilings

 **Aluminium-Einbaustrahler (für LED-Module)**

- Aluminiumkörper
- Einbaulichtquelle - Keine Blendung
- Einsatz in Hängedecken, Befestigung durch Sprenglingen

 **Spots encastrables en Aluminium (pour platine LED)**

- Corps en aluminium
- Source lumineuse en retrait - Anti-éblouissement
- Pour utilisation en faux-plafond, fixation avec ressorts

 **Focos empotrables de Aluminio (para Módulos de LED)**

- Cuerpo de aluminio
- Foco empotrable - No deslumbra
- Para ser utilizado en techo



# FLIP

QUALIKO  
PROFESSIONAL LIGHT COMPONENTS  
srl



Incassi Alluminio • AluminiumFixtures





Type	Part N°	Dimensions (mm)	Standard	Colour	 (mm)	Packing box dimensions (mm)	Packing box weight (kg)
FLIP SMALL	<b>B40080050T1B</b>	Ø89,5x61,5h	MR16	White	Ø70,5	115x95x65h	0,44
FLIP LARGE	<b>B80040111T1B</b>	Ø148x62,5h	AR111	White	Ø120	155x155x65h	0,75

Vedere pagina 168 per i kit che includono la lampadina LED - See page 168 for kits including LED lamp

## FLIP SMALL B40080050T1B

### Faretti per incasso in Alluminio (per Moduli LED)

- Corpo in alluminio
- Fonte luminosa arretrata anti-abbagliamento
- Per utilizzo in controsoffitti, fissaggio con molle

### Recessed Aluminium light fixtures (for LED Modules)

- Aluminum body
- Recessed light source - No dazzle
- To be used in counter ceilings

### Aluminium-Einbaustrahler (für LED-Module)

- Aluminiumkörper
- Einbaulichthequelle - Keine Blendung
- Einsatz in Hängedecken, Befestigung durch Sprengringen

### Spots encastrables en Aluminium (pour platine LED)

- Corps en aluminium
- Source lumineuse en retrait - Anti-éblouissement
- Pour utilisation en faux-plafond, fixation avec ressorts

### Focos empotrables de Aluminio (para Módulos de LED)

- Cuerpo de aluminio
- Foco empotrable - No deslumbra
- Para ser utilizado en techo

## FLIP LARGE B80040111T1B

### Faretti per incasso in Alluminio (per Moduli LED)

- Corpo in alluminio
- Fonte luminosa arretrata anti-abbagliamento
- Per utilizzo in controsoffitti, fissaggio con molle

### Recessed Aluminium light fixtures (for LED Modules)

- Aluminum body
- Recessed light source - No dazzle
- To be used in counter ceilings

### Aluminium-Einbaustrahler (für LED-Module)

- Aluminiumkörper
- Einbaulichthequelle - Keine Blendung
- Einsatz in Hängedecken, Befestigung durch Sprengringen

### Spots encastrables en Aluminium (pour platine LED)

- Corps en aluminium
- Source lumineuse en retrait - Anti-éblouissement
- Pour utilisation en faux-plafond, fixation avec ressorts

### Focos empotrables de Aluminio (para Módulos de LED)

- Cuerpo de aluminio
- Foco empotrable - No deslumbra
- Para ser utilizado en techo



Incassi Alluminio • Aluminium fixtures



Type	Part N°	Dimensions (mm)	Standard	Colour	 (mm)	Packing box dimensions (mm)	Packing box weight (kg)
MAYA T1A	<b>B10221050T1A</b>	Ø93	MR16	Aluminium	80	100x100x50h	0,16
MAYA T1N	<b>B10231050T1N</b>	Ø93	MR16	Black	80	100x100x50h	0,16
MAYA T1B	<b>B10221050T1B</b>	Ø93	MR16	White	80	100x100x50h	0,16

Vedere pagina 168 per i kit che includono la lampadina LED - See page 168 for kits including LED lamp

 **Faretti per incasso in Alluminio (per Moduli LED)**

- Corpo in alluminio
- Orientabile
- Per utilizzo in controsoffitti, fissaggio con molle

 **Recessed Aluminium light fixtures (for LED Modules)**

- Aluminium body
- Adjustable
- To be used in counter ceilings

 **Aluminium-Einbaustrahler (für LED-Module)**

- Aluminiumkörper
- Schwenkbar
- Einsatz in Hängedecken, Befestigung durch Sprengringen

 **Spots encastrables en Aluminium (pour platine LED)**

- Corps en aluminium
- Orientable
- Pour utilisation en faux-plafond, fixation avec ressorts

 **Focos empotrables de Aluminio (para Módulos de LED)**

- Cuerpo de aluminio
- Ajustable
- Para ser utilizado en techo

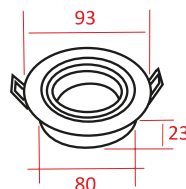

# BABEL

QUALIKO  
PROFESSIONAL LIGHT COMPONENTS  
srl



Incassi Alluminio • Aluminium fixtures



Type	Part N°	Dimensions (mm)	Standard	Colour	 (mm)	Packing box dimensions (mm)	Packing box weight (kg)
BABEL Q1A	<b>B10421050Q1A</b>	93x93x23h	MR16	Aluminium	Ø80	115x100x45h	0,16
BABEL Q2A	<b>B18293050Q2A</b>	175x90x23h	MR16	Aluminium	160x80	185x160x45h	0,34
BABEL Q1N	<b>B10423050Q1N</b>	93x93x23h	MR16	Black	Ø80	115x100x45h	0,16
BABEL Q2N	<b>B11824050Q2N</b>	175x90x23h	MR16	Black	160x80	185x160x45h	0,34
BABEL Q1B	<b>B10421050Q1B</b>	93x93x23h	MR16	White	Ø80	115x100x45h	0,16
BABEL Q2B	<b>B18293050Q2B</b>	175x90x23h	MR16	White	160x80	185x160x45h	0,34

Vedere pagina 168 per i kit che includono la lampadina LED - See page 168 for kits including LED lamp

 **Faretti per incasso in Alluminio (per Moduli LED)**

- Corpo in alluminio
- Orientabile
- Per utilizzo in controsoffitti, fissaggio con molle

 **Recessed Aluminium light fixtures (for LED Modules)**

- Aluminium body
- Adjustable
- To be used in counter ceilings

 **Aluminium-Einbaustrahler (für LED-Module)**

- Aluminiumkörper
- Schwenkbar
- Einsatz in Hängedecken, Befestigung durch Sprengringen

 **Spots encastrables en Aluminium (pour platine LED)**

- Corps en aluminium
- Orientable
- Pour utilisation en faux-plafond, fixation avec ressorts

 **Focos empotrables de Aluminio (para Módulos de LED)**

- Cuerpo de aluminio
- Ajustable
- Para ser utilizado en techo

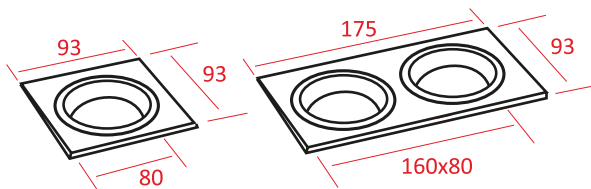

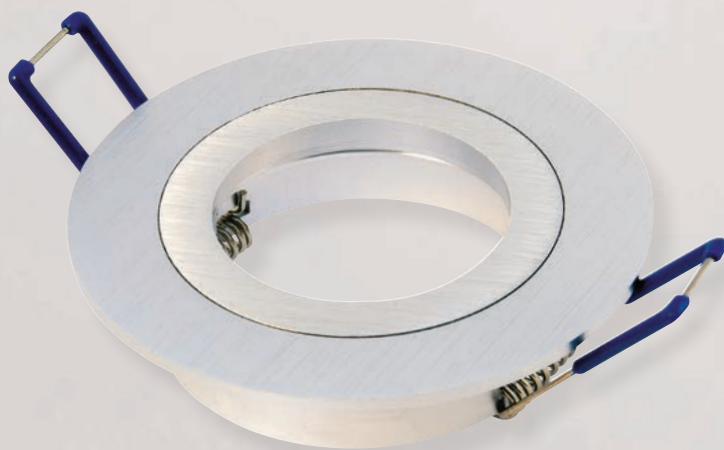

Incassi Alluminio • Aluminium fixtures



Vedere pagina 168 per i kit che includono la lampadina LED - See page 168 for kits including LED lamp



Type	Part N°	Dimensions (mm)	Standard	Colour	 (mm)	Packing box dimensions (mm)	Packing box weight (kg)
BASIC 50	<b>B11265E50T1A</b>	Ø78	MR16	Aluminium	Ø60	95x75x45h	0,090
BASIC 35	<b>B10701E35T1A</b>	Ø53	MR11	Aluminium	Ø43	95x80x50h	0,055

 **Faretti per incasso in Alluminio (per Moduli LED)**

- Corpo in alluminio
- Orientamento fisso
- Per utilizzo in controsoffitti, fissaggio con molle

 **Recessed Aluminium light fixtures (for LED Modules)**

- Aluminum body
- Not Adjustable
- To be used in counter ceilings

 **Aluminium-Einbaustrahler (für LED-Module)**

- Aluminiumkörper
- Starr
- Einsatz in Hängedecken, Befestigung durch Sprengringen

 **Spots encastrables en Aluminium (pour platine LED)**

- Corps en aluminium
- Orientation fixée
- Pour utilisation en faux-plafond, fixation avec ressorts

 **Focos empotrables de Aluminio (para Módulos de LED)**

- Cuerpo de aluminio
- No ajustable
- Para ser utilizado en techo

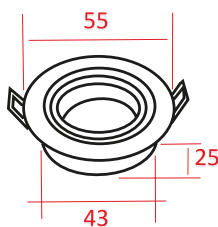

**BASIC 35**

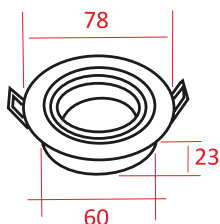

**BASIC 50**



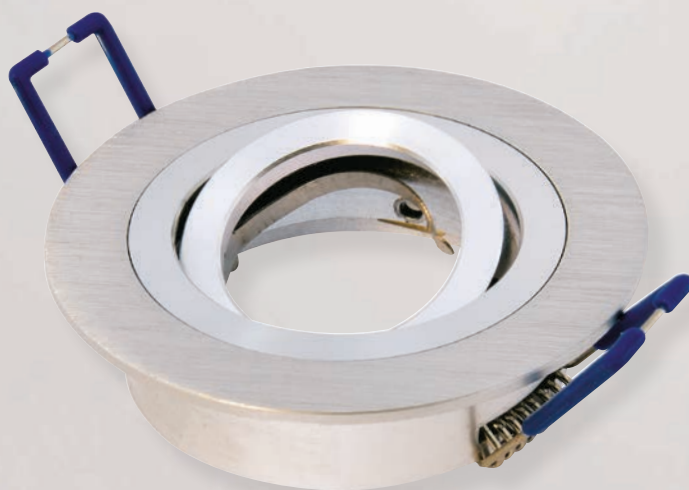
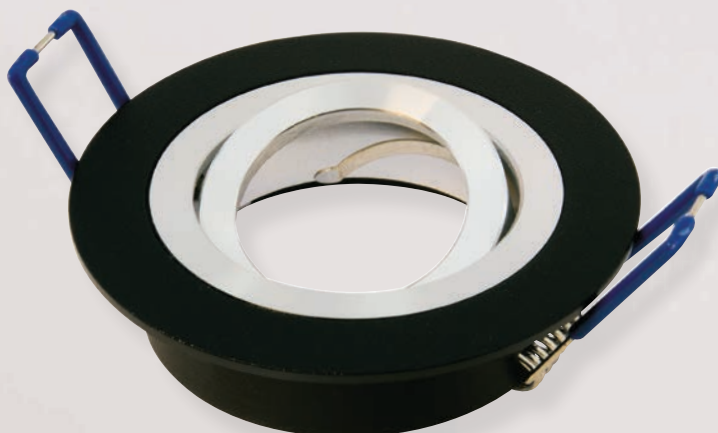

Incassi Alluminio • Aluminium fixtures





Type	Part N°	Dimensions (mm)	Standard	Colour	 (mm)	Packing box dimensions (mm)	Packing box weight (kg)
INKA T1A	B13506035T1A	Ø70	MR11	Aluminium	Ø60	100x80x45h	0,080
INKA T1N	B13505035T1N	Ø70	MR11	Black	Ø60	100x80x45h	0,080



 **Faretti per incasso in Alluminio (per Moduli LED)**

- Corpo in alluminio
- Orientabile
- Per utilizzo in controsoffitti, fissaggio con molle

 **Recessed Aluminium light fixtures (for LED Modules)**

- Aluminum body
- Adjustable
- To be used in counter ceilings

 **Aluminium-Einbaustrahler (für LED-Module)**

- Aluminiumkörper
- Schwenkbar
- Einsatz in Hängedecken, Befestigung durch Sprengringen

 **Spots encastrables en Aluminium (pour platine LED)**

- Corps en aluminium
- Orientable
- Pour utilisation en faux-plafond, fixation avec ressorts

 **Focos empotrables de Aluminio (para Módulos de LED)**

- Cuerpo de aluminio
- Ajustable
- Para ser utilizado en techo

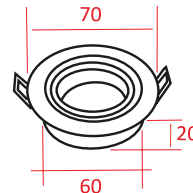



Incassi Alluminio • Aluminium fixtures



Type	Part N°	Dimensions (mm)	Standard	Colour	 (mm)	Packing box dimensions (mm)	Packing box weight (kg)
TEBE Q1A	<b>B13601035Q1A</b>	70x70x19h	MR11	Aluminium	Ø60	95x80x40h	0,090
TEBE Q1B	<b>B13601035Q1B</b>	70x70x19h	MR11	White	Ø60	95x80x40h	0,090
TEBE Q1N	<b>B13608035Q1N</b>	70x70x19h	MR11	Black	Ø60	95x80x40h	0,090
TEBE Q2A	<b>B13621035Q2A</b>	140x70x19h	MR11	Aluminium	125x60	160x110x45h	0,185
TEBE Q2N	<b>B13628035Q2N</b>	140x70x19h	MR11	Black	125x60	160x110x45h	0,185



 **Faretti per incasso in Alluminio (per Moduli LED)**

- Corpo in alluminio
- Orientabile
- Per utilizzo in controsoffitti, fissaggio con molle

 **Recessed Aluminium light fixtures (for LED Modules)**

- Aluminium body
- Adjustable
- To be used in counter ceilings

 **Aluminium-Einbaustrahler (für LED-Module)**

- Aluminiumkörper
- Schwenkbar
- Einsatz in Hängedecken, Befestigung durch Sprengringen

 **Spots encastrables en Aluminium (pour platine LED)**

- Corps en aluminium
- Orientable
- Pour utilisation en faux-plafond, fixation avec ressorts

 **Focos empotrables de Aluminio (para Módulos de LED)**

- Cuerpo de aluminio
- Ajustable
- Para ser utilizado en techo

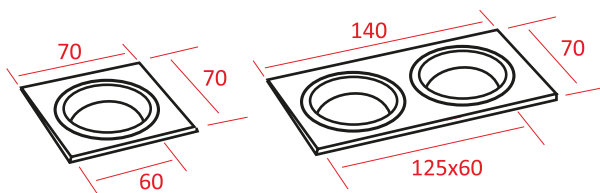

# ECLYPSE

QUALIKO  
PROFESSIONAL LIGHT COMPONENTS  
srl



Incassi Alluminio • Aluminium fixtures



Type	Part N°	Dimensions (mm)	Standard	Colour	 (mm)	Packing box dimensions (mm)	Packing box weight (kg)
ECLYPSE T1A	<b>B39100111T1A</b>	Ø180	AR111	Aluminium	Ø145	210x190x45h	0,380
ECLYPSE T1N	<b>B39400111T1N</b>	Ø180	AR111	Black	Ø145	210x190x45h	0,380
ECLYPSE T1B	<b>B39100111T1B</b>	Ø180	AR111	White	Ø145	210x190x45h	0,380

Vedere pagina 168 per i kit che includono la lampadina LED e il driver - See page 168 for kits including LED lamp and driver

 **Faretti per incasso in Alluminio (per Moduli LED)**

- Corpo in alluminio
- Orientabile
- Per utilizzo in controsoffitti, fissaggio con molle

 **Recessed Aluminium light fixtures (for LED Modules)**

- Aluminum body
- Adjustable
- To be used in counter ceilings

 **Aluminium-Einbaustrahler (für LED-Module)**

- Aluminiumkörper
- Schwenkbar
- Einsatz in Hängedecken, Befestigung durch Sprengingen

 **Spots encastrables en Aluminium (pour platine LED)**

- Corps en aluminium
- Orientable
- Pour utilisation en faux-plafond, fixation avec ressorts

 **Focos empotrables de Aluminio (para Módulos de LED)**

- Cuerpo de aluminio
- Ajustable
- Para ser utilizado en techo

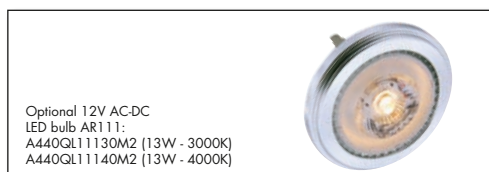
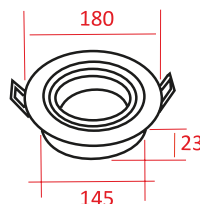



Incassi Alluminio • Aluminium fixtures



Type	Part N°	Dimensions (mm)	Standard	Colour	Ø (mm)	Packing box dimensions (mm)	Packing box weight (kg)
ZENITH Q1A	<b>B31100111Q1A</b>	180x180x23	AR111	Aluminium	Ø145	210x190x45h	0,320
ZENITH Q2A	<b>B32100111Q2A</b>	360x180x23	AR111	Aluminium	315x145	365x210x45h	0,800
ZENITH Q3A	<b>B33100111Q3A</b>	530x180x23	AR111	Aluminium	495x145	540x210x45h	1,170
ZENITH Q1B	<b>B31100111Q1B</b>	180x180x23	AR111	White	Ø145	210x190x45h	0,320
ZENITH Q2B	<b>B32100111Q2B</b>	360x180x23	AR111	White	315x145	365x210x45h	0,800
ZENITH Q3B	<b>B33100111Q3B</b>	530x180x23	AR111	White	495x145	540x210x45h	1,170

Vedere pagina 168 per i kit che includono la lampadina LED e il driver - See page 168 for kits including LED lamp and driver

**Italy** Faretto per incasso in Alluminio (per Moduli LED)

- Corpo in alluminio
- Orientabile
- Per utilizzo in controsoffitti, fissaggio con molle

**UK** Recessed Aluminium light fixtures (for LED Modules)

- Aluminium body
- Adjustable
- To be used in counter ceilings

**Germany** Aluminium-Einbaustrahler (für LED-Module)

- Aluminiumkörper
- Schwenkbar
- Einsatz in Hängedecken, Befestigung durch Sprengringen

**France** Spots encastrables en Aluminium (pour platine LED)

- Corps en aluminium
- Orientable
- Pour utilisation en faux-plafond, fixation avec ressorts

**Spain** Focos empotrables de Aluminio (para Módulos de LED)

- Cuerpo de aluminio
- Ajustable
- Para ser utilizado en techo

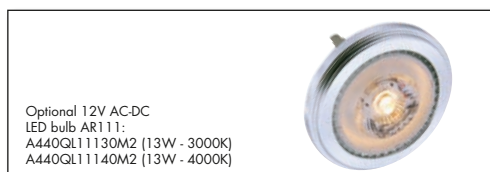
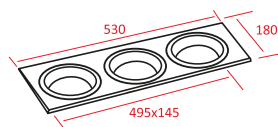
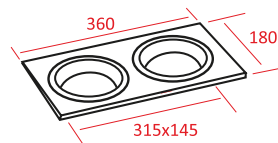
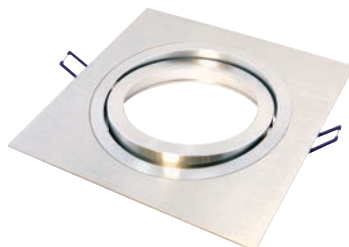
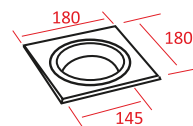

# LAMPADINE LED

QUALIKO  
PROFESSIONAL LIGHT COMPONENTS  
srl



Lampadine LED • LED bulbs





CE EMC ErP RoHS

Type	Part N°	Dimensions (mm)	Beam angle	CRI	Colour	°Kelvin	Lumen	Power W	Dimming Triac	Weight Kg
GU10 4000K	<b>BLCT7GU1040D</b>	Ø 50x57h	36°	>80	Natural White	4000°K	700	7	5 ÷ 95%	0,047
GU10 3000K	<b>BLCT7GU1030D</b>	Ø 50x57h	36°	>80	Warm White	3000°K	670	7	5 ÷ 95%	0,047

### Lampadina LED GU10 dimmerabile

- Compatibile con la maggior parte di dimmer a TRIAC
- Vita stimata 20000 h
- Corpo in plastica termica e dissipatore interno in alluminio
- Temperatura ambiente da -20°C ÷ +40° C
- Protezione surge 700V
- LED Samsung SMD 2835
- **Quantità minima vendibile 20 pezzi**

### GU10 dimmable LED bulb

- Compatible with most TRIAC dimmers
- Estimated life 20000 h
- Body in thermal plastic and internal heat sink in aluminum
- Ambient temperature from -20 °C ÷ +40 °C
- 700V surge protection
- Samsung SMD 2835 LED
- **Minimum salable quantity 20 pieces**

### Dimmbare GU10 Led-Lampe

- Mit der Mehrheit der Phasenanschnittsdimmer kompatibel
- Lebensdauer: 20000 h
- Thermoleitfähiger Kunststoffkörper und integriertem Alukühlkörper
- Ta: -20°C ÷ +40° C
- Surge-Schutz 700V
- LED Samsung SMD 2835
- **Mindestverkaufsmenge 20 Stück**

### Lampe à LED GU10 dimmable

- Compatible avec la plupart des dimmer TRIAC
- Durée de vie: 20000 h
- Corps en matière thermique et dissipateur interne en aluminium
- Température ambiante de -20°C à +40° C
- Protection surge 700V

- LED Samsung SMD 2835
- **Quantité minimal vendable 20 pièces**

### Bombilla LED regulable GU10

- Compatible con la mayoría de los reguladores TRIAC
- Vida estimada 20000 h
- Cuerpo en plástico térmico y disipador de calor interno en aluminio
- Temperatura ambiente de -20°C ÷ +40°C
- Protección contra sobretensiones de 700V
- Samsung SMD 2835LED
- **Cantidad mínima vendible 20 piezas**



# KITS con alimentatori e/o fonti luminose including drivers and/or light sources

QUALIKO

## Lampade LED • LED Lamps

BFLYFIT270PW	FLYLINE	PAG. N° 2	Warm White 2700K	Including: A41H24210A27 + A40PBF10000B
BFLYFIT300PW	FLYLINE	PAG. N° 2	Warm White 3000K	Including: A41H24210A30 + A40PBF10000B
BFLYFIT400PN	FLYLINE	PAG. N° 2	Natural White 4000K	Including: A41H24210A40 + A40PBF10000B

## Incassi Gypsolyte • Gypsolyte fixtures

CB9129G50Q1W	ARAGON	PAG. N° 54	Warm White 3000K	Including: BPORTGU1020N + BLC7GU1030D
CB9129G50Q1N	ARAGON	PAG. N° 54	Natural White 4000K	Including: BPORTGU1020N + BLC7GU1040D
CB9247G11Q1W	ARAGON XL	PAG. N° 56	Warm White 3000K	Including: A40QL11130M2 + A10MT030000B
CB9247G11Q1N	ARAGON XL	PAG. N° 56	Natural White 4000K	Including: A40QL11140M2 + A10MT030000B
CB9128GV5Q1W	ARAGON GLASS	PAG. N° 58	Warm White 3000K	Including: BPORTGU1020N + BLC7GU1030D
CB9128GV5Q1N	ARAGON GLASS	PAG. N° 58	Natural White 4000K	Including: BPORTGU1020N + BLC7GU1040D
CB9222G50Q1W	ARAGON FLAT	PAG. N° 60	Warm White 3000K	Including: BPORTGU1020N + BLC7GU1030D
CB9222G50Q1N	ARAGON FLAT	PAG. N° 60	Natural White 4000K	Including: BPORTGU1020N + BLC7GU1040D
CB9223G50Q2W	ARAGON TWIN	PAG. N° 62	Warm White 3000K	Including: 2x BPORTGU1020N + 2x BLC7GU1030D
CB9223G50Q2N	ARAGON TWIN	PAG. N° 62	Natural White 4000K	Including: 2x BPORTGU1020N + 2x BLC7GU1040D
CB9130G50T1W	OBLO'	PAG. N° 64	Warm White 3000K	Including: BPORTGU1020N + BLC7GU1030D
CB9130G50T1N	OBLO'	PAG. N° 64	Natural White 4000K	Including: BPORTGU1020N + BLC7GU1040D
CB9248G11T1W	OBLO' XL	PAG. N° 66	Warm White 3000K	Including: A40QL11130M2 + A10MT030000B
CB9248G11T1N	OBLO' XL	PAG. N° 66	Natural White 4000K	Including: A40QL11140M2 + A10MT030000B
CB9132V50T1W	OBLO' GLASS	PAG. N° 68	Warm White 3000K	Including: BPORTGU1020N + BLC7GU1030D
CB9132V50T1N	OBLO' GLASS	PAG. N° 68	Natural White 4000K	Including: BPORTGU1020N + BLC7GU1040D
CB9224G50T1W	OBLO' FLAT	PAG. N° 70	Warm White 3000K	Including: BPORTGU1020N + BLC7GU1030D
CB9224G50T1N	OBLO' FLAT	PAG. N° 70	Natural White 4000K	Including: BPORTGU1020N + BLC7GU1040D
CB9131G50Q1W	SLIDE	PAG. N° 72	Warm White 3000K	Including: BPORTGU1020N + BLC7GU1030D
CB9131G50Q1N	SLIDE	PAG. N° 72	Natural White 4000K	Including: BPORTGU1020N + BLC7GU1040D
CB9229G50Q1W	DIAGONAL	PAG. N° 74	Warm White 3000K	Including: BPORTGU1020N + BLC7GU1030D
CB9229G50Q1N	DIAGONAL	PAG. N° 74	Natural White 4000K	Including: BPORTGU1020N + BLC7GU1040D
CB9284G50Q1W	BEAT	PAG. N° 76	Warm White 3000K	Including: BPORTGU1020N + BLC7GU1030D
CB9284G50Q1N	BEAT	PAG. N° 76	Natural White 4000K	Including: BPORTGU1020N + BLC7GU1040D
CB9285G50T1W	SOUL	PAG. N° 78	Warm White 3000K	Including: BPORTGU1020N + BLC7GU1030D
CB9285G50T1N	SOUL	PAG. N° 78	Natural White 4000K	Including: BPORTGU1020N + BLC7GU1040D
CB9286G35Q1W	SNAP	PAG. N° 80	Warm White 3000K	Including: BKITR08SL24W
CB9286G35Q1N	SNAP	PAG. N° 80	Natural White 4000K	Including: BKITR08SL24N
B9287G35Q1W	LOOP	PAG. N° 82	Warm White 3000K	Including: BKITR08SL24W
B9287G35Q1N	LOOP	PAG. N° 82	Natural White 4000K	Including: BKITR08SL24N
CB9262G50Q1W	NEOS SMALL	PAG. N° 84	Warm White 3000K	Including: BPORTGU1020N + BLC7GU1030D
CB9262G50Q1N	NEOS SMALL	PAG. N° 84	Natural White 4000K	Including: BPORTGU1020N + BLC7GU1040D
CB9263G50Q1W	NEOS MEDIUM	PAG. N° 84	Warm White 3000K	Including: BPORTGU1020N + BLC7GU1030D
CB9263G50Q1N	NEOS MEDIUM	PAG. N° 84	Natural White 4000K	Including: BPORTGU1020N + BLC7GU1040D
CB9264G50Q1W	NEOS LARGE	PAG. N° 84	Warm White 3000K	Including: BPORTGU1020N + BLC7GU1030D
CB9264G50Q1N	NEOS LARGE	PAG. N° 84	Natural White 4000K	Including: BPORTGU1020N + BLC7GU1040D
CB9268G50T1W	ARGO SMALL	PAG. N° 86	Warm White 3000K	Including: BPORTGU1020N + BLC7GU1030D
CB9268G50T1N	ARGO SMALL	PAG. N° 86	Natural White 4000K	Including: BPORTGU1020N + BLC7GU1040D
CB9269G50T1W	ARGO MEDIUM	PAG. N° 86	Warm White 3000K	Including: BPORTGU1020N + BLC7GU1030D
CB9269G50T1N	ARGO MEDIUM	PAG. N° 86	Natural White 4000K	Including: BPORTGU1020N + BLC7GU1040D
CB9270G50T1W	ARGO LARGE	PAG. N° 86	Warm White 3000K	Including: BPORTGU1020N + BLC7GU1030D
CB9270G50T1N	ARGO LARGE	PAG. N° 86	Natural White 4000K	Including: BPORTGU1020N + BLC7GU1040D

## Incassi LED • LED Downlights

CBD0950TNW1B	ROUND 95	PAG. N° 88	Natural White 4200K	Including: Driver A40PDV24000B
CBD1400TNW1B	ROUND 140	PAG. N° 88	Natural White 4200K	Including: Driver A40PDV24000B
CBD1700TNW1B	ROUND 170	PAG. N° 88	Natural White 4200K	Including: Driver A40PDV24000B
CBD2000TNW1B	ROUND 200	PAG. N° 88	Natural White 4200K	Including: Driver A40PDV24000B
CBD2750TNW1B	ROUND 275	PAG. N° 88	Natural White 4200K	Including: Driver A40FB036000B
CBD3300TNW1B	ROUND 330	PAG. N° 88	Natural White 4200K	Including: Driver A40FB036000B

CBD0950TWW1B	ROUND 95	PAG. N° 88	Warm White 3000K	Including: Driver A40PDV24000B
CBD1400TWW1B	ROUND 140	PAG. N° 88	Warm White 3000K	Including: Driver A40PDV24000B
CBD1700TWW1B	ROUND 170	PAG. N° 88	Warm White 3000K	Including: Driver A40PDV24000B
CBD2000TWW1B	ROUND 200	PAG. N° 88	Warm White 3000K	Including: Driver A40PDV24000B
CBD2750TWW1B	ROUND 275	PAG. N° 88	Warm White 3000K	Including: Driver A40FB036000B
CBD3300TWW1B	ROUND 330	PAG. N° 88	Warm White 3000K	Including: Driver A40FB036000B

# KITS con alimentatori e/o fonti luminose including drivers and/or light sources

QUALIKO

CBD135CTNW0B	ORION 135	PAG. N° 90	Natural White 4000K	Including: Driver A40PD309000B
CBD160CTNW0B	ORION 160	PAG. N° 90	Natural White 4000K	Including: Driver A40PD309000B
CBD190CTNW0B	ORION 190	PAG. N° 90	Natural White 4000K	Including: Driver A40PD309000B
CBD228CTNW0B	ORION 228	PAG. N° 90	Natural White 4000K	Including: Driver A40MCS03000B
CBD135CTWW0B	ORION 135	PAG. N° 90	Warm White 3000K	Including: Driver A40PD309000B
CBD160CTWW0B	ORION 160	PAG. N° 90	Warm White 3000K	Including: Driver A40PD309000B
CBD190CTWW0B	ORION 190	PAG. N° 90	Warm White 3000K	Including: Driver A40PD309000B
CBD228CTWW0B	ORION 228	PAG. N° 90	Warm White 3000K	Including: Driver A40MCS03000B
CBDCL10208WB	LAKE SMALL	PAG. N° 92	Warm White 3000K	Including: Driver A40PLK18500B
CBDCL10213WB	LAKE LARGE	PAG. N° 92	Warm White 3000K	Including: Driver A40PLK30000B
CBDCL10208NB	LAKE SMALL	PAG. N° 92	Natural White 4000K	Including: Driver A40PLK18500B
CBDCL10213NB	LAKE LARGE	PAG. N° 92	Natural White 4000K	Including: Driver A40PLK30000B
CBD19BASTNW0B	OPERA 190	PAG. N° 94	Natural White 4000K	Including: Driver A40PDMC0000B
CBD27BASTNW0B	OPERA 270	PAG. N° 94	Natural White 4000K	Including: Driver A40MCS03000B
CBD19BASTWW0B	OPERA 190	PAG. N° 94	Warm White 3000K	Including: Driver A40PDMC0000B
CBD27BASTWW0B	OPERA 270	PAG. N° 94	Warm White 3000K	Including: Driver A40MCS03000B
CBD13BASTNW0B	KARMA 130	PAG. N° 96	Natural White 4000K	Including: Driver A40PD312000B
CBD28BASTNW0B	KARMA 280	PAG. N° 96	Natural White 4000K	Including: Driver A40MCS03000B
CBD13BASTWW0B	KARMA 130	PAG. N° 96	Warm White 3000K	Including: Driver A40PD312000B
CBD28BASTWW0B	KARMA 280	PAG. N° 96	Warm White 3000K	Including: Driver A40MCS03000B

## Pannelli LED • LED Panels

CBPL6060EACW	60x60 Alu frame	PAG. N° 104	Cool White 6000K	Including: Driver A40PBF06000B
CBPL6060EANW	60x60 Alu frame	PAG. N° 104	Natural White 4200K	Including: Driver A40PBF06000B
CBPL6060EAWW	60x60 Alu frame	PAG. N° 104	Warm White 3000K	Including: Driver A40PBF06000B
CBPL6012EANW	60x120 Alu frame	PAG. N° 106	Natural White 4200K	Including: Driver A40PBF10000B
CBPL6012EAWW	60x120 Alu frame	PAG. N° 106	Warm White 3000K	Including: Driver A40PBF10000B
CBPL3030EACW	30x30 Alu frame	PAG. N° 108	Cool White 6000K	Including: Driver A40PDV24000B
CBPL3030EANW	30x30 Alu frame	PAG. N° 108	Natural White 4200K	Including: Driver A40PDV24000B
CBPL3030EAWW	30x30 Alu frame	PAG. N° 108	Warm White 3000K	Including: Driver A40PDV24000B
CBPL3060EACW	30x60 Alu frame	PAG. N° 108	Cool White 6000K	Including: Driver A40FB036000B
CBPL3060EANW	30x60 Alu frame	PAG. N° 108	Natural White 4200K	Including: Driver A40FB036000B
CBPL3060EAWW	30x60 Alu frame	PAG. N° 108	Warm White 3000K	Including: Driver A40FB036000B
CBPL30120ECW	30x120 Alu frame	PAG. N° 108	Cool White 6000K	Including: Driver A40PBF06000B
CBPL30120ENW	30x120 Alu frame	PAG. N° 108	Natural White 4200K	Including: Driver A40PBF06000B
CBPL30120EWW	30x120 Alu frame	PAG. N° 108	Warm White 3000K	Including: Driver A40PBF06000B
CBPL3030EARG	30x30 Alu frame	PAG. N° 114	RGB	Including: Driver/Controller A40RGBOX424B
CBPL6060EARG	60x60 Alu frame	PAG. N° 114	RGB	Including: Driver/Controller A40RGBOX424B
CBPL6012EARG	60x120 Alu frame	PAG. N° 114	RGB	Including: Driver/Controller A40RGBOX424B

## Plafoniere LED • LED Fixtures

CBAW2253009N	WALLY 30 25°	PAG. N° 116	Natural White 4000K	Including: Driver A40PDV24000B
CBAW2453009N	WALLY 30 45°	PAG. N° 116	Natural White 4000K	Including: Driver A40PDV24000B
CBAW2251235N	WALLY 120 25°	PAG. N° 116	Natural White 4000K	Including: Driver A40FB036000B
CBAW2451235N	WALLY 120 45°	PAG. N° 116	Natural White 4000K	Including: Driver A40FB036000B
CBAW2253009W	WALLY 30 25°	PAG. N° 116	Warm White 3000K	Including: Driver A40PDV24000B
CBAW2453009W	WALLY 30 45°	PAG. N° 116	Warm White 3000K	Including: Driver A40PDV24000B
CBAW2251235W	WALLY 120 25°	PAG. N° 116	Warm White 3000K	Including: Driver A40FB036000B
CBAW2451235W	WALLY 120 45°	PAG. N° 116	Warm White 3000K	Including: Driver A40FB036000B

# KITS con alimentatori e/o fonti luminose including drivers and/or light sources

QUALIKO™

CBAW2253009R	WALLY 30 25° RGB	PAG. N° 118	RGB	Including: Driver/Controller A40RGBOX424B
CBAW2453009R	WALLY 30 45° RGB	PAG. N° 118	RGB	Including: Driver/Controller A40RGBOX424B
CBAW2251235R	WALLY 120 25° RGB	PAG. N° 118	RGB	Including: Driver/Controller A40RGBOX424B
CBAW2251235R	WALLY 120 45° RGB	PAG. N° 118	RGB	Including: Driver/Controller A40RGBOX424B

## Incassi Alluminio • Aluminium fixtures

CBJ140205TBN	SWING WHITE	PAG. N° 146	Natural White 4000K	Including: BLC7GU1040D
CBJ140205TBW	SWING WHITE	PAG. N° 146	Warm White 3000K	Including: BLC7GU1030D
CBJ140205TNN	SWING BLACK	PAG. N° 146	Natural White 4000K	Including: BLC7GU1040D
CBJ140205TNW	SWING BLACK	PAG. N° 146	Warm White 3000K	Including: BLC7GU1030D
CB1501001QBN	GLAM SQUARE WHITE	PAG. N° 148	Natural White 4000K	Including: BPORTGU1020N + BLC7GU1040D
CB1501001QBW	GLAM SQUARE WHITE	PAG. N° 148	Warm White 3000K	Including: BPORTGU1020N + BLC7GU1030D
CB1501095TBN	GLAM ROUND WHITE	PAG. N° 148	Natural White 4000K	Including: BPORTGU1020N + BLC7GU1040D
CB1501095TBW	GLAM ROUND WHITE	PAG. N° 148	Warm White 3000K	Including: BPORTGU1020N + BLC7GU1030D
CB1501095TNN	GLAM ROUND BLACK	PAG. N° 148	Natural White 4000K	Including: BPORTGU1020N + BLC7GU1040D
CB1501095TNW	GLAM ROUND BLACK	PAG. N° 148	Warm White 3000K	Including: BPORTGU1020N + BLC7GU1030D
CB4008000TBN	FLIP SMALL	PAG. N° 150	Natural White 4000K	Including: BPORTGU1020N + BLC7GU1040D
CB4008000TBW	FLIP SMALL	PAG. N° 150	Warm White 3000K	Including: BPORTGU1020N + BLC7GU1030D
CB8004011TBN	FLIP LARGE	PAG. N° 150	Natural White 4000K	Including: A40QL11140M2 + A10MT030000B
CB8004011TBW	FLIP LARGE	PAG. N° 150	Warm White 3000K	Including: A40QL11130M2 + A10MT030000B
CB102210T0AN	MAYA ALU	PAG. N° 152	Natural White 4000K	Including: BPORTGU1020N + BLC7GU1040D
CB102210T0AW	MAYA ALU	PAG. N° 152	Warm White 3000K	Including: BPORTGU1020N + BLC7GU1030D
CB102210T0BN	MAYA WHITE	PAG. N° 152	Natural White 4000K	Including: BPORTGU1020N + BLC7GU1040D
CB102210T0BW	MAYA WHITE	PAG. N° 152	Warm White 3000K	Including: BPORTGU1020N + BLC7GU1030D
CB102210T0NN	MAYA BLACK	PAG. N° 152	Natural White 4000K	Including: BPORTGU1020N + BLC7GU1040D
CB102210T0NW	MAYA BLACK	PAG. N° 152	Warm White 3000K	Including: BPORTGU1020N + BLC7GU1030D
CB104210Q1AN	BABEL 1 ALU	PAG. N° 154	Natural White 4000K	Including: BPORTGU1020N + BLC7GU1040D
CB104210Q1AW	BABEL 1 ALU	PAG. N° 154	Warm White 3000K	Including: BPORTGU1020N + BLC7GU1030D
CB182930Q2AN	BABEL 2 ALU	PAG. N° 154	Natural White 4000K	Including: 2x BPORTGU1020N + 2x BLC7GU1040D
CB182930Q2AW	BABEL 2 ALU	PAG. N° 154	Warm White 3000K	Including: 2x BPORTGU1020N + 2x BLC7GU1030D
CB104210Q1BN	BABEL 1 WHITE	PAG. N° 154	Natural White 4000K	Including: BPORTGU1020N + BLC7GU1040D
CB104210Q1BW	BABEL 1 WHITE	PAG. N° 154	Warm White 3000K	Including: BPORTGU1020N + BLC7GU1030D
CB182930Q2BN	BABEL 2 WHITE	PAG. N° 154	Natural White 4000K	Including: 2x BPORTGU1020N + 2x BLC7GU1040D
CB182930Q2BW	BABEL 2 WHITE	PAG. N° 154	Warm White 3000K	Including: 2x BPORTGU1020N + 2x BLC7GU1030D
CB104230Q1NN	BABEL 1 BLACK	PAG. N° 154	Natural White 4000K	Including: BPORTGU1020N + BLC7GU1040D
CB104230Q1NW	BABEL 1 BLACK	PAG. N° 154	Warm White 3000K	Including: BPORTGU1020N + BLC7GU1030D
CB118240Q2NN	BABEL 2 BLACK	PAG. N° 154	Natural White 4000K	Including: 2x BPORTGU1020N + 2x BLC7GU1040D
CB118240Q2NW	BABEL 2 BLACK	PAG. N° 154	Warm White 3000K	Including: 2x BPORTGU1020N + 2x BLC7GU1030D
CB11265ET1AN	BASIC 50 ALU	PAG. N° 156	Natural White 4000K	Including: BPORTGU1020N + BLC7GU1040D
CB11265ET1AW	BASIC 50 ALU	PAG. N° 156	Warm White 3000K	Including: BPORTGU1020N + BLC7GU1030D
CB391000T1AN	ECLYPSE ALU	PAG. N° 162	Natural White 4000K	Including: A40QL11140M2 + A10MT030000B
CB391000T1AW	ECLYPSE ALU	PAG. N° 162	Warm White 3000K	Including: A40QL11130M2 + A10MT030000B
CB391000T1BN	ECLYPSE WHITE	PAG. N° 162	Natural White 4000K	Including: A40QL11140M2 + A10MT030000B
CB391000T1BW	ECLYPSE WHITE	PAG. N° 162	Warm White 3000K	Including: A40QL11130M2 + A10MT030000B
CB394000T1BN	ECLYPSE BLACK	PAG. N° 162	Natural White 4000K	Including: A40QL11140M2 + A10MT030000B
CB394000T1BW	ECLYPSE BLACK	PAG. N° 162	Warm White 3000K	Including: A40QL11130M2 + A10MT030000B

# KITS con alimentatori e/o fonti luminose including drivers and/or light sources

QUALIKO™

CB311000Q1AN	ZENITH 1 ALU	PAG. N° 164	Natural White 4000K	Including: A40TR1140M00 + A40SL125000B
CB311000Q1AW	ZENITH 1 ALU	PAG. N° 164	Warm White 3000K	Including: A40TR1130M00 + A40SL125000B
CB321000Q2AN	ZENITH 2 ALU	PAG. N° 164	Natural White 4000K	Including: 2x A40TR1140M00 + 2x A40SL125000B
CB321000Q2AW	ZENITH 2 ALU	PAG. N° 164	Warm White 3000K	Including: 2x A40TR1130M00 + 2x A40SL125000B
CB331000Q3AN	ZENITH 3 ALU	PAG. N° 164	Natural White 4000K	Including: 3x A40TR1140M00 + 3x A40SL125000B
CB331000Q3AW	ZENITH 3 ALU	PAG. N° 164	Warm White 3000K	Including: 3x A40TR1130M00 + 3x A40SL125000B
CB311000Q1BN	ZENITH 1 WHITE	PAG. N° 164	Natural White 4000K	Including: A40TR1140M00 + A40SL125000B
CB311000Q1BW	ZENITH 1 WHITE	PAG. N° 164	Warm White 3000K	Including: A40TR1130M00 + A40SL125000B
CB321000Q2BN	ZENITH 2 WHITE	PAG. N° 164	Natural White 4000K	Including: 2x A40TR1140M00 + 2x A40SL125000B
CB321000Q2BW	ZENITH 2 WHITE	PAG. N° 164	Warm White 3000K	Including: 2x A40TR1130M00 + 2x A40SL125000B
CB331000Q3BN	ZENITH 3 WHITE	PAG. N° 164	Natural White 4000K	Including: 3x A40TR1140M00 + 3x A40SL125000B
CB331000Q3BW	ZENITH 3 WHITE	PAG. N° 164	Warm White 3000K	Including: 3x A40TR1130M00 + 3x A40SL125000B

## Prodotti in esaurimento • Discontinued products

CBD1000QNW1B	SQUARE 100	PAG. N° 172	Natural White 4200K	Including: Driver A40PDV24000B
CBD1000QWW1B	SQUARE 100	PAG. N° 172	Warm White 3000K	Including: Driver A40PDV24000B
CBD1500QNW1B	SQUARE 150	PAG. N° 172	Natural White 4200K	Including: Driver A40PDV24000B
CBDCL10308NB	MIST SMALL	PAG. N° 172	Natural White 4000K	Including: Driver A40PLK18500B
CBDCL10313NB	MIST LARGE	PAG. N° 172	Natural White 4000K	Including: Driver A40PLK30000B
CBD078CTNW0B	BUD 78	PAG. N° 173	Natural White 4000K	Including: Driver A40NICE2060B
CBD098CTNW0B	BUD 98	PAG. N° 173	Natural White 4000K	Including: Driver A40PLK11300B
CBD116CTNW0B	BUD 116	PAG. N° 173	Natural White 4000K	Including: Driver A40PLK11200B
CBD142CTNW0B	BUD 142	PAG. N° 173	Natural White 4000K	Including: Driver A40PDMC0000B
CBD210CTNW0B	BUD 210	PAG. N° 173	Natural White 4000K	Including: Driver A40MCS03000B
CBD098CTWW0B	BUD 98	PAG. N° 173	Warm White 3000K	Including: Driver A40PLK11300B
CBD116CTWW0B	BUD 116	PAG. N° 173	Warm White 3000K	Including: Driver A40PLK11200B
CBD142CTWW0B	BUD 142	PAG. N° 173	Warm White 3000K	Including: Driver A40PDMC0000B
CBD210CTWW0B	BUD 210	PAG. N° 173	Warm White 3000K	Including: Driver A40MCS03000B
CB9259G11Q1W	CUBE	PAG. N° 173	Warm White 3000K	Including: A40QL11130M2 + A10MT030000B
CB9259G11Q1N	CUBE	PAG. N° 173	Natural White 4000K	Including: A40QL11140M2 + A10MT030000B
CB8444G0T2BN	PIPE ROUND	PAG. N° 178	Warm White 3000K	Including: 2x BPORTGU1020N + 2x BLCT7GU1030D
CB8444G0T2BW	PIPE ROUND	PAG. N° 178	Natural White 4000K	Including: 2x BPORTGU1020N + 2x BLCT7GU1040D
CB8443G0T2BN	PIPE SQUARE	PAG. N° 178	Warm White 3000K	Including: 2x BPORTGU1020N + 2x BLCT7GU1030D
CB8443G0T2BW	PIPE SQUARE	PAG. N° 178	Natural White 4000K	Including: 2x BPORTGU1020N + 2x BLCT7GU1040D
CB2308G50Q1W	ARIEL	PAG. N° 178	Warm White 3000K	Including: BLCT7GU1030D
CB2308G50Q1N	ARIEL	PAG. N° 178	Natural White 4000K	Including: BLCT7GU1040D
CB2309G50T1W	PEGASUS	PAG. N° 178	Warm White 3000K	Including: BLCT7GU1030D
CB2309G50T1N	PEGASUS	PAG. N° 178	Natural White 4000K	Including: BLCT7GU1040D



## SQUARE

**Incastro LED quadrato extrapiatto**

- LED ad alta efficienza

**24 Volt**  
Safety Voltage

**Square extra flat recessed LED downlight**

- High efficiency LED



Vedere pagina 168 per i kit che includono il driver LED - See page 168 for kits including LED driver

RAL 9010

Type	Part N°	Dimensions (mm)	Colour	°Kelvin	Lumen	Power (W)	Installation hole (mm)	Packing box dimensions (mm)	Weight (kg)
SQUARE 100 NW	<b>BD10024QNW1B</b>	100x100x28h	Natural White	4200°K	303	6	90x90	200x190x60h	0,26
SQUARE 100 WW	<b>BD10024QWW1B</b>	100x100x28h	Warm White	3000°K	286	6	90x90	200x190x60h	0,26
SQUARE 150 NW	<b>BD15024QNW1B</b>	150x150x28h	Natural White	4200°K	727	11	125x125	250x240x60h	0,46



## MIST

**Incastro LED tondo alta potenza IP65**

- LED ad alta efficienza



**Round IP65 high power recessed LED downlight**

- High efficiency LED

Vedere pagina 168 per i kit che includono il driver LED - See page 168 for kits including LED driver

Type	Part N°	Dimensions (mm)	Colour	Lumen (Lm)	Voltage Max (V)	Current Max (mA)	Beam °	Power Max (W)	Installation hole (mm)	Packing box dimensions (mm)	Weight (kg)
MIST SMALL NW	<b>BDCL103A08NB</b>	∅ 80x30h	NW 4000°K	863	38	185	60°	8	∅ 70	115x110x75	0,25
MIST LARGE NW	<b>BDCL103A13NB</b>	∅ 110x50h	NW 4000°K	1318	38	300	60°	13	∅ 95	135x125x110	0,45



## POP

**Incastro a LED tondo ad alta potenza**

- Installazione semplice e veloce - Funziona direttamente a tensione di rete con alimentatore incorporato - Lunga durata



**Round extra powerful recessed LED downlight**

- Easy and quick installation - Works directly with mains voltage (Built-in driver) - Long life time

Type	Part N°	Dimensions (mm)	Colour	Lumen (Lm)	Input V	Beam °	Power Max (W)	Installation hole (mm)	Packing box dimensions (mm)	Weight (kg)
POP 145 NW	<b>BDL14510NWOB</b>	∅ 145x79h	NW 4000°K	900	100÷240	100°	10	∅ 125	150x150x92h	0,25
POP 175 NW	<b>BDL17513NWOB</b>	∅ 175x85h	NW 4000°K	1200	100÷240	100°	13	∅ 150	180x180x96h	0,35



## BUD

### Incasso a LED tondo ad alta potenza

- Led CITIZEN - Cornice estetica e struttura dissipante in alluminio
- Grande omogeneità luminosa
- Per installazioni di tipo professionale - Funziona in bassa tensione con trasformatore elettronico specifico a corrente costante, fornito a richiesta - Lunga durata



### Round extra powerful recessed LED downlight

- CITIZEN led - Dissipating structure and aesthetic frame in aluminum - High brightness homogeneity
- For professional use - Safety low voltage with specific constant current driver (supplied on request)
- Long life time

Vedere pagina 168 per i kit che includono il driver LED - See page 168 for kits including LED driver

Type	Part N°	Dimensions (mm)	Colour	Lumen (lm)	Voltage Max (V)	Current Max (mA)	Beam °	Power Max (W)	Installation hole (mm)	Packing box dimensions (mm)	Weight (kg)
BUD 78 NW	BD078CCTNWOB	Ø 78x53h	NW 4000°K	324	11	500	46°	6	Ø67	115x96x85	0,13
BUD 98 NW	BD098CCTNWOB	Ø 96x60h	NW 4000°K	606	40	240	40°	10	Ø83	130x120x90	0,21
BUD 116 NW	BD116CCTNWOB	Ø 116x80h	NW 4000°K	998	40	350	20°	14	Ø102	155x125x100	0,31
BUD 142 NW	BD142CCTNWOB	Ø 142x101h	NW 4000°K	1336	40	500	25°	20	Ø122	160x160x130	0,57
BUD 210 NW	BD210CCTNWOB	Ø 210x150h	NW 4000°K	1911	39	700	50°	28	Ø180	215x215x180	1,56
BUD 98 WW	BD098CCTWWOB	Ø 96x60h	WW 3000°K	562	40	240	40°	10	Ø83	130x120x90	0,21
BUD 116 WW	BD116CCTWWOB	Ø 116x80h	WW 3000°K	921	40	350	20°	14	Ø102	155x125x100	0,31
BUD 142 WW	BD142CCTWWOB	Ø 142x101h	WW 3000°K	1299	40	500	25°	20	Ø122	160x160x130	0,57
BUD 210 WW	BD210CCTWWOB	Ø 210x150h	WW 3000°K	1879	39	700	50°	28	Ø180	215x215x180	1,56



## CUBE

### Alloggiamento da soffitto AR111 in Gypsolite

- Orientabile
- Adatto a moduli LED standard AR111
- Installazione a soffitto
- Lampada non inclusa



### Gypsolite AR111 ceiling fixture

- Adjustable
- Suitable for standard AR111 LED modules
- To be installed on ceiling
- Bulb not included

Vedere pagina 168 per i kit che includono il LED driver e lampadina LED  
See page 168 for kits including LED driver and LED bulb

Type	Part n°	Dimensions mm	Standard	Colour	Packing box dimensions (mm)	Packing box (kg)
CUBE	B9259G111Q1B	190x190x220h	AR111	White	290x245x250h	5,10



**NEXT** Lampade LED Gypsolyte • LED Gypsolyte lamps

- Applique LED**
- Struttura in Gypsolyte
  - Grande omogeneità luminosa
  - Funziona in bassa tensione con trasformatore incorporato
  - Consumo molto limitato
  - Lunga durata



- LED wall lamp**
- Structure in Gypsolyte
  - Homogeneous light output
  - Safety low voltage with specific included driver
  - Limited consumption
  - Long life time

Type	Part N°	Input (V)	Power (W)	Lumen	Light Colour	°Kelvin (±10%)	CRI	Dimensions (mm)	Packing box dimensions (mm)	Weight (kg)
NEXT NW	<b>BW8521GLEDNW</b>	100÷250 AC	11±1	1210	NW	4000°K	>80	178X147X125h	230x180x210h	1,20
NEXT WW	<b>BW8521GLEDWW</b>	100÷250 AC	11±1	1190	WW	3000°K	>80	178X147X125h	230x180x210h	1,20
NEXT GOLD NW	<b>BW8521GOLDNW</b>	100÷250 AC	11±1	1210	NW	4000°K	>80	178X147X125h	230x180x210h	1,20
NEXT GOLD WW	<b>BW8521GOLDWW</b>	100÷250 AC	11±1	1190	WW	3000°K	>80	178X147X125h	230x180x210h	1,20



**NEXT** Lampade LED Cemento • LED Concrete lamps

- Applique LED**
- Struttura in Cemento
  - Grande omogeneità luminosa
  - Funziona in bassa tensione con trasformatore incorporato
  - Consumo molto limitato
  - Lunga durata



- LED wall lamp**
- Structure in Concrete
  - Homogeneous light output
  - Safety low voltage with specific included driver
  - Limited consumption
  - Long life time

Type	Part N°	Input (V)	Power (W)	Lumen	Light Colour	°Kelvin (±10%)	CRI	Dimensions (mm)	Packing box dimensions (mm)	Weight (kg)
NEXT	<b>BWC8521LEDNW</b>	100÷250 AC	11±1	1210	NW	4000°K	>80	178X147X125h	230x180x210h	1,20
NEXT	<b>BWC8521LEDWW</b>	100÷250 AC	11±1	1190	WW	3000°K	>80	178X147X125h	230x180x210h	1,20





## CHRONOS Lampade LED Gypsolyte • LED Gypsolyte lamps



### Applique LED

- Struttura in Gypsolyte
- Grande omogeneità luminosa
- Funziona in bassa tensione con trasformatore incorporato
- Consumo molto limitato
- Lunga durata



### LED wall lamp

- Structure in Gypsolyte
- Homogeneous light output
- Safety low voltage with specific included driver
- Limited consumption
- Long life time

Type	Part N°	Input (V)	Power (W)	Lumen	Light Colour	°Kelvin (±10%)	CRI	Dimensions (mm)	Packing box dimensions (mm)	Weight (kg)
CHRONOS	<b>BW8440GLEDNW</b>	100÷250 AC	8±1	940	NW	4000°K	>80	Ø155x59h	200x200x130h	1,00
CHRONOS	<b>BW8440GLEDWW</b>	100÷250 AC	8±1	890	WW	3000°K	>80	Ø155x59h	200x200x130h	1,00
CHRONOS GOLD	<b>BW8440GOLDNW</b>	100÷250 AC	8±1	940	NW	4000°K	>80	Ø155x59h	200x200x130h	1,00
CHRONOS GOLD	<b>BW8440GOLDWW</b>	100÷250 AC	8±1	890	WW	3000°K	>80	Ø155x59h	200x200x130h	1,00



## CHRONOS Lampade LED Cemento • LED Concrete lamps



### Applique LED

- Struttura in Cemento
- Grande omogeneità luminosa
- Funziona in bassa tensione con trasformatore incorporato
- Consumo molto limitato
- Lunga durata



### LED wall lamp

- Structure in Concrete
- Homogeneous light output
- Safety low voltage with specific included driver
- Limited consumption
- Long life time

Type	Part N°	Input (V)	Power (W)	Lumen	Light Colour	°Kelvin (±10%)	CRI	Dimensions (mm)	Packing box dimensions (mm)	Weight (kg)
CHRONOS	<b>BWC8440LEDNW</b>	100÷250 AC	8±1	940	NW	4000°K	>80	Ø155x59h	200x200x130h	1,00
CHRONOS	<b>BWC8440LEDWW</b>	100÷250 AC	8±1	890	WW	3000°K	>80	Ø155x59h	200x200x130h	1,00



## BILLY

### Plafoniere LED IP50

- Struttura in Policarbonato bianco e schermo in PMMA - Grande omogeneità luminosa
- Funziona in bassa tensione con trasformatore incorporato - Consumo molto limitato
- Lunga durata



### IP50 LED Fixture

- Structure and frame in Polycarbonate, PMMA screen - Homogeneous light output
- Safety low voltage with specific included driver - Limited consumption - Long life time

Type	Part N°	Dimensions (mm)	Light Colour	° Kelvin (±10%)	Lumen	Power (W)	Input (V)	CRI	IP	Packing box dimensions (mm)	Weight (kg)
BILLY 10	BIL50241040B	Ø240x65h	NW	4200°K	890	10±1	100÷240 AC	>80	IP50	245x245x69h	0,60



## AQUA

### Plafoniere LED IP54

- Struttura in Policarbonato bianco e schermo in PMMA - Grande omogeneità luminosa
- Funziona in bassa tensione con trasformatore incorporato - Consumo molto limitato
- Lunga durata



### IP54 LED Fixture

- Structure and frame in Polycarbonate, PMMA screen - Homogeneous light output
- Safety low voltage with specific included driver - Limited consumption - Long life time

Type	Part N°	Dimensions (mm)	Light Colour	° Kelvin (±10%)	Lumen	Power (W)	Input (V)	CRI	IP	Packing box dimensions (mm)	Weight (kg)
AQUA 10 NW	BIL271040IPB	Ø270x90h	NW	4200°K	890	10±1	100÷240 AC	>80	IP54	250x250x110h	0,80
AQUA 20 NW	BIL322040IPB	Ø330x100h	NW	4200°K	1680	20±1	100÷240 AC	>80	IP54	360x360x110h	1,10
AQUA 10 WW	BIL271030IPB	Ø270x90h	WW	3000°K	872	10±1	100÷240 AC	>80	IP54	250x250x110h	0,80
AQUA 20 WW	BIL322030IPB	Ø330x100h	WW	3000°K	1646	20±1	100÷240 AC	>80	IP54	360x360x110h	1,10

## TORPEDO



### Plafoniera stagna LED IP65

- Sostituisce la tradizionale plafoniera stagna fluorescente - Corpo in Alluminio.
- Applicazioni tipiche: uffici, aree produttive, supermercati, laboratori, etc.



### LED waterproof IP65 fitting

- Ideal replacement for traditional fluo waterproof fitting - Aluminum body.
- Typical applications: offices, manufacturing areas, supermarkets, laboratories, etc.

Type	Part N°	Dimensions (mm)	Input V	Weight kg	Flux (lm)	° Kelvin	Power (W max)	Beam
TORPEDO 70	BS700000400G	1180x145x65	100÷240	5,90	4430 Lm	4000°K	70	120°



## DAKOTA

### Proiettore LED IP65

- LED ad alta efficienza Bridgelux - Accensione istantanea

### IP65 LED flood

- Bridgelux high efficiency LED - Instant ON-OFF



Type	Part N°	Dimensions (mm)	Weight kg	Flux (lm)	°Kelvin	Power W max)	Packing box dimensions (mm)	Packing box Weight (kg)
DAKOTA 70	<b>BF362870400N</b>	360x285x115h	5,500	5565	4100°	70	365x290x118h	5,800



## SLIM

### Proiettore LED IP65

- LED ad alta efficienza - Accensione istantanea

### IP65 LED flood

- High efficiency LED - Instant ON-OFF



Type	Part N°	Dimensions	Weight kg	Lumen	°Kelvin (W)	Power	IP	Packing box Dimensions (mm)
SLIM 10 Black	<b>BFSLIM10400N</b>	135x90x20	0,55	630	4000	10	IP65	180x145x40
SLIM 10 White	<b>BFSLIM10400B</b>	135x90x20	0,55	630	4000	10	IP65	180x145x40
SLIM 30 Black	<b>BFSLIM30400N</b>	240x163x30	1,70	2250	4000	30	IP65	300x230x60
SLIM 50 Black	<b>BFSLIM50400N</b>	296x208x37	2,70	3700	4000	50	IP65	360x270x80
SLIM 50 White	<b>BFSLIM50400B</b>	296x208x37	2,70	3700	4000	50	IP65	360x270x80



## HIGH BAY (first generation)

### Campana a LED IP54

- LED ad alta efficienza Bridgelux - Power Factor > 0,9 - Accensione istantanea

### IP54 High power LED high bay

- Bridgelux high efficiency LED - Power factor >0,9 - Instant ON-OFF



Type	Part N°	IP	Dimensions (mm)	Input V	Weight kg	LED (Bridgelux)	Flux (lm)	° Kelvin	Campana Bell	Power (W max)	Beam	CRI
HIGH BAY150	<b>BC150B4IP54A</b>	IP54	400x400x560h	90÷264	8,00	4	10500 Lm	4000°K	Aluminium	150	90°	70



## PIPE

- Applicque in Gypsolyte**
- Struttura in Gypsolyte
  - Adatto a moduli LED standard MR16
  - Installazione a parete

- Gypsolyte wall fixture**
- Structure in Gypsolyte
  - Suitable for standard MR16 LED modules
  - To be installed on wall

Vedere pagina 168 per i kit che includono la lampadina LED - See page 168 for kits including LED lamp



Type	Part n°	Dimensions mm	Standard	Colour	Packing box dimensions (mm)	Packing box (kg)
PIPE Round	<b>B8444G050T2B</b>	98x74x249h	2x MR16	White	290x150x120h	1,20
PIPE Square	<b>B8443G050Q2B</b>	98x74x249h	2x MR16	White	290x150x120h	1,20



## ARIEL & PEGASUS

- Sospensione in Gypsolyte**
- Struttura in Gypsolyte

- Gypsolyte pendant fixture**
- Structure in Gypsolyte

Vedere pagina 168 per i kit che includono la lampadina LED - See page 168 for kits including LED lamp



Type	Part n°	Dimensions mm	Standard	Colour	Packing box dimensions (mm)	Packing box (kg)
ARIEL	<b>B2308G050Q1B</b>	70x70x250h	MR16	White	300x180x130h	1,80
PEGASUS	<b>B2309G050T1B</b>	Ø70x250h	MR16	White	300x180x130h	1,30

- Condizioni di Garanzia • Garantie Conditions
- Garantiebedingungen • Conditions de Garantie
- Condiciones de Garantia

**Garanzia a vita sulla sicurezza, 24 mesi operatività e performance**

- La garanzia è valida su tutto il territorio della Comunità Europea e decorre dalla data di fabbricazione indicata sull'etichetta dei prodotti o in fattura. Al di fuori della comunità Europea la garanzia è fornita attraverso l'importatore.
- La garanzia sulla sicurezza elettrica è coperta da assicurazione che prevede il rimborso di tutte le spese sostenute comprese le spese legali e quelle di trasporto e smontaggio del materiale difettoso
- La garanzia sul funzionamento decorre dalla data di fabbricazione e prevede la sostituzione del solo valore della merce entro due anni dalla data di produzione.
- La garanzia copre tutti i difetti di fabbricazione - La garanzia non copre gli eventuali difetti e/o danni per utilizzo non conforme alle istruzioni d'installazione e ai dati di targa o in impianti non conformi alle norme generali di sicurezza.
- La garanzia decade se i prodotti sono stati manomessi o riparati, se ci sono delle controversie sui pagamenti o non vengono fornite le necessarie informazioni atte a determinare la causa dei guasti - La garanzia non è valida per impianti adibiti ad uso militare, aeronautico o medico-sanitario: l'impiego in tali settori deve essere preventivamente autorizzato.
- Non sono contemplate nella garanzia le parti soggette ad usura ( Si considera normale usura il decadimento luminoso dei led nel tempo) - Sono esclusi dalla garanzia i danni causati da eventi atmosferici (fulmini, allagamenti o simili).
- La garanzia riguarda solo il valore del prodotto e non i costi di trasporto e smontaggio o perizia.
- Il materiale difettoso deve essere reso in porto franco nostro stabilimento e dopo specifica autorizzazione scritta. In caso di merce in garanzia verrà resa al cliente senza addebito di spese di trasporto.
- Impianti o apparecchi di illuminazione che comprendono i nostri componenti devono essere provati dal cliente prima della messa in commercio sia per la sicurezza elettrica sia per la compatibilità elettromagnetica, non si risponde per danni causati da impianti non testati preventivamente.
- In caso di controversie il foro competente è quello di Milano

**"All - life" guarantee for safety  
Two years guarantee for working and performances**

- These guarantees are valid for the field of installation in the whole Europe Both these guarantee periods start from the date of production printed on the label.
- Warranty is granted by the Importer in countries out of European Community.
- All products are covered by a special insurance policy (product-civil responsibility) valid worldwide and covering the compensation of damages caused by the product itself, the call-back of the products from the market and their replacement and the hand-user's compensation for an eventual termination of his trade due to a defect of the product.
- Both the guarantees cover products installed in indoor environments and civil systems, provided that temperature instructions and right installation are carefully followed.
- The guarantees cover all production defects imputable to the manufacturer but not the damages resulting from wrongly following the installation and use instructions.
- The guarantees are no longer valid if the products are unduly opened or tampered with, if there are controversies about payments or if the customer doesn't supply detailed information about the causes of the product bad functioning.
- The guarantees does not cover military installations, aeronautical and medical environments: the use of our products in these environments must be previously authorized.
- The guarantee does not cover the components subject to wear and tear (lamps, fluorescent tubes, shorted fuses) and damages due to atmospheric agents, lightning, flooding and so on.
- Besides the damages already covered by RCP insurance, these guarantee covers only the price of the product and not the costs for transport, disassembly and damage valuation.
- Defective goods must be returned to our address only after having received specific authorization and the freight costs are ex works.
- Competent court Legnano - Milan.

**Lebenslängliche Sicherheitsgarantie  
24-Monate Betriebs- und Leistungsgarantie**

- Diese Garantien sind für das Installationsgebiet in der ganze CE gültig - Diese Garantien laufen seit dem auf dem Gerät angebrachten Datum.
- Alle Produkte sind durch eine weltweit gültige RCP-Versicherung abgedeckt: diese Garantie deckt Schadenersatz wegen der Produkten selbst, die Kosten für Rücklieferungen der defekte Ware, den Ersatz der Produkten auf dem Markt und, wenn notwendig, Kostenersatz wegen einer mögliche Betriebsunterbrechung des Endverbraucher.
- Beide Garantien decken die Produkte, die nur in Inneninstallationen und zivilen Gebieten eingesetzt sind und nur wenn man den empfehlenden Temperaturwerten und den Installationsnormen folgt.
- Beide Garantien erstrecken sich auf alle eventuell auftretenden Defekte, die

auf Fabrikationsfehler zurückzuführen sind aber sie decken keine eventuell auftretenden Defekte und Schäden, die auf unsachgemäßen Gebrauch oder unfachmännische Installation zurückzuführen sind.

- Die Garantien erlöschen beim Öffnen und unsachgemäßer Handhabung der Produkte, bei Bezahlsauseinandersetzung und wenn keine notwendigen Nachrichten über die Ursachen der Schäden mitgeteilt werden - Diese Garantien decken keine Anlage im militärischen und medizinischen Gebiet: der Gebrauch unseren Produkten in diesen Gebieten muß vorher genehmigt.
- Diese Garantien decken keine unverschleißfeste Bauelemente (Glühbirnen, Leuchtstoffröhren, Schmelzdrahten) und keine Schäden, die von Wetterlagen, wie Blitzen und Alluvionen, verursacht sind.
- Neben den anderen schon von RCP-Versicherung gedeckten Schäden, decken diese Garantien nur den Produktpreis aber keine Fracht- und Montagekosten.
- Defekte Ware muß immer ab unserem Werk und nur mit unserer schriftlichen Vorausgenehmigung zurückgeliefert werden.
- Zuständiges Gericht Legnano - Mailand.

**Sécurité garantie à vie  
Fonctionnement garanti deux ans**





- Ces garanties sont valables pour les installations dans tous les pays de la Communauté Européenne et s'appliquent à partir de la date de fabrication indiquée sur l'étiquette des produits.
- Tous les produits sont couverts par une Assurance Responsabilité Civile, une Police RC Produits pour le remboursement des dommages causés par le produit lui-même, pour le remboursement des frais de retrait des produits, remplacement et substitution des produits sur le marché, et, si nécessaire, dédommagement à l'utilisateur des frais entraînés par l'interruption de son activité.
- La garantie sécurité à vie et la garantie de deux ans pour le fonctionnement s'appliquent en cas de produits installés dans des logements civils. L'assurance ne couvrira pas les dommages causés en cas de non-respect des températures maximums et/ou de mauvaise installation.
- La garantie couvre tous les défauts dérivant de la fabrication - La garantie ne couvre pas les défauts éventuels et/ou les dommages imputables à un usage non conforme aux instructions d'installation ou à des installations ne respectant pas les normes générales sur la sécurité.
- La garantie ne s'appliquera pas en cas d'altération ou de réparation sur les produits, paiement non effectué, informations insuffisantes à la détermination de la cause du dommage - La garantie ne s'applique pas aux installations destinées à l'usage militaire, aéronautique ou médical: dans ces trois secteurs une autorisation préalable devra être requise.
- Sont exclues de la garantie les ampoules, les tubes fluorescents, les fusibles - La garantie ne s'applique pas en cas d'orage, d'inondations etc.
- La garantie ne couvre que le prix du produit à l'exclusion des frais de transport, désassemblage ou expertise.
- Les produits défectueux doivent être renvoyés en port payé à notre usine et uniquement après autorisation écrite.
- En cas de controverse: compétence juridique Tribunal de Legnano - Milan.

**Garantía de seguridad por vida  
Garantía de funcionamiento de dos años**

- Estas garantías son válidas en todos los países de la Comunidad Europea y se aplican a partir de la fecha de fabricación indicada en la etiqueta de los productos
- Todos los productos están cubiertos por un seguro de responsabilidad civil, póliza RC de producto, para el reembolso de los daños causados por los productos, los gastos de retirada, y sustitución de los productos en el mercado, y en caso necesario indemnización del usuario por los costes de interrupción de su actividad
- La garantía de seguridad por vida y la de funcionamiento de dos años se aplican en el caso de montaje en interiores en instalaciones civiles - La garantía no cubre los daños causados por no respetar las temperaturas máximas y/o mala instalación.
- La garantía cubre todos los defectos de fabricación imputables al fabricante - La garantía no cubre los defectos eventuales y/o los daños imputables a un uso no conforme a las instrucciones de instalación o en instalaciones que no

- La garantía no es aplicable en los casos de alteración o reparación de los productos, falta de pago, o informaciones insuficientes para la determinación de la causa del fallo - La garantía no se aplica a instalaciones de uso militar, aeronáutico o médico: en esos tres sectores se requiere una autorización previa.
- Las piezas sometidas a desgaste como lámparas, tubos fluorescentes, fusibles, etc. están excluidas La garantía no se aplica en caso de fenómenos atmosféricos como rayos o inundaciones.
- La garantía solo cubre el valor del producto con exclusión de los gastos de transporte, desmontaje y peritación.
- Previa autorización escrita, los productos defectuosos deben ser enviados con portes pagados a nuestra dirección.
- En caso de litigio la competencia corresponde al tribunal de Legnano - Milan.

Le illustrazioni e le descrizioni riportate nella presente pubblicazione si riferiscono alle informazioni più aggiornate disponibili al momento della stampa. I dati tecnici e le caratteristiche dei modelli possono essere soggetti, in qualsiasi momento, a modifiche senza obbligo di preavviso.  
All illustrations and specifications illustrated in this brochure are based on the last production available at the time of printing. We reserve the right to modify materials and other characteristics without prior notice.

-  Come raggiungerci
-  How to reach us
-  Wie uns zu erreichen
-  Pour arriver chez nous
-  Por llegar en nuestras oficinas





**QUALIKO**

Via Carlo dell'Acqua, 35 • 20027 Rescaldina (MI) - Italy • Tel. +39 0331 466695 • Fax +39 0331 468273  
[www.qualiko.it](http://www.qualiko.it) • [info@qualiko.it](mailto:info@qualiko.it)