

RL
live your light

VENTILATOREN | FANS



2024



INHALT / CONTENT



VISBY 6

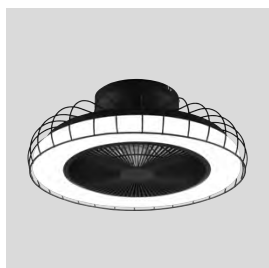

SANDFJORD 8



HALMSTAD 10



FLAGA 11



HARSTAD 12



STRALSUND 14



UMEA 18

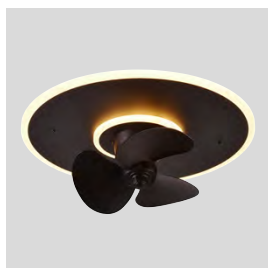

NYBRO 20



BORGHOLM 22



SORTLAND 23



VARBERG 24



LINDBERG 25



FARSUND 26

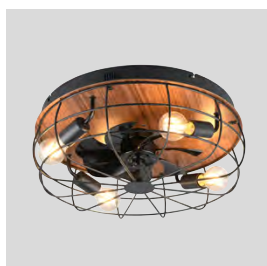

TRONDHEIM 28



LILLESAND 29



KARLSBORG 30



YSTAD 31

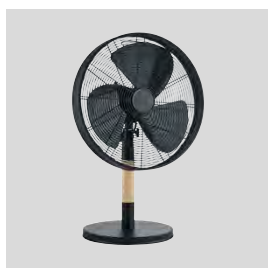

VIKING 32



VIKING 32



TROMSÖ 34



TEMPEST 35



ICEBERG 36



KALMAR 37



BREEZY 38

DC Motor

Deckenventilatoren mit DC-Motor (Gleichstrom-Elektromotor) sind sehr energiesparend und äußerst zuverlässig. Zudem laufen DC-Ventilatoren außerordentlich leise und sehr gleichmäßig. Sie eignen sich perfekt für Ruhebereiche, z. B. das Schlafzimmer, Kinderzimmer, Lesebereiche und Büros.

Ein weiterer Pluspunkt ist der Vor- und Rückwärtslauf bzw. Sommer- und Winterbetrieb. Im Sommer sollte der Deckenventilator gegen den Uhrzeigersinn gedreht werden, um den Luftstrom direkt nach unten zu leiten, der für eine kühle Brise sorgt. Im Winter muss der Ventilator im Uhrzeigersinn laufen, um einen Aufwind zu erzeugen und die warme Luft im Raum besser zu verteilen.

Ceiling fans with a DC motor (direct current electric motor) are very energy-efficient and extremely reliable. DC fans also run extremely quietly and very smoothly. They are perfect for quiet areas, e.g. bedrooms, children's rooms, reading areas and offices.

Another plus point is the forward and reverse operation or summer and winter operation. In summer, the ceiling fan should be turned anticlockwise to direct the airflow straight downwards, which creates a cool breeze. In winter, the fan must run clockwise to create an updraft and better distribute the warm air in the room.

Sommerbetrieb | Summer operation



Winterbetrieb | Winter operation

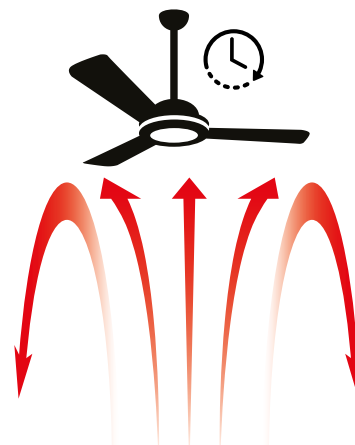

Vorteile DC-Ventilatoren
Advantages of DC fans

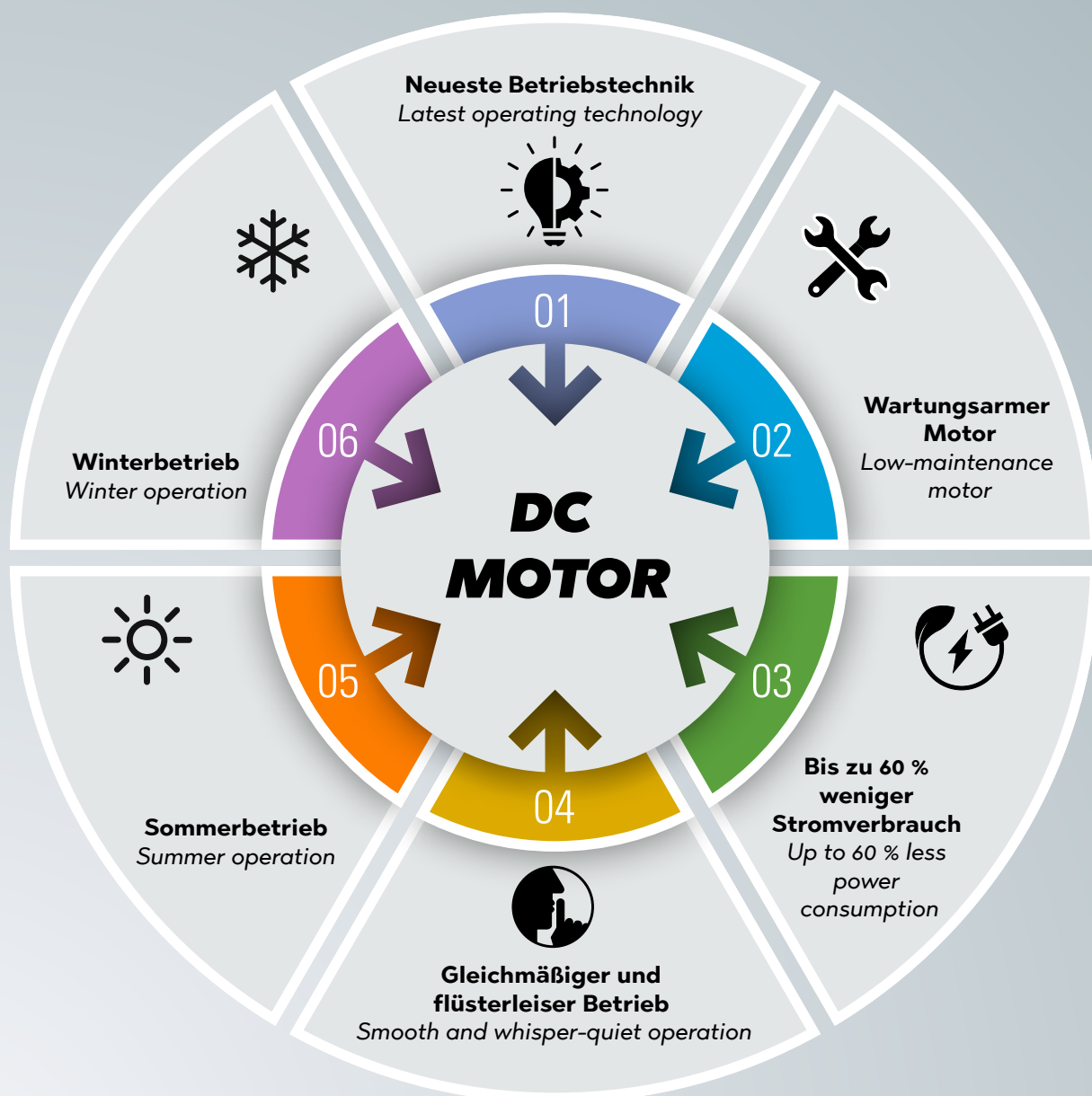

VISBY

Kunststoff | Plastic
Weiß Chrom | White chrome



1



2



6

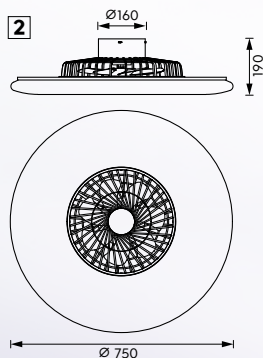
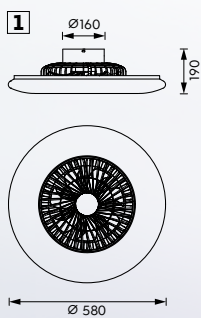

	Art-Nr. Art. No.	Leuchtmittel Lamps	Leuchtenlichtstrom Luminous flux	Lichtfarbe Light color	DC-Motor DC-Engine	Leistung Motor Power Engine	Volumenstrom Volume flow
1	R62402106	incl. SMD-LED, 38 W	4.400 lm	2.700 - 6.500 K		40 W	33,24 m ³ /min
2	R62402906	incl. SMD-LED, 56 W	6.600 lm	2.700 - 6.500 K	✓	15 W	33,24 m ³ /min





SANDFJORD

Metall | metal
 Chrom | chrome



2



1

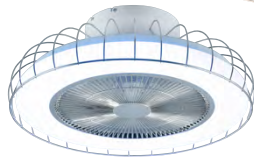

SMART LIGHTING

www.trio-lighting.com/wiz

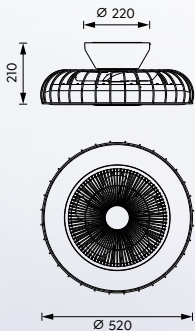

Art-Nr. Art. No.	Leuchtmittel Lamps	Leuchtenlichtstrom Luminous flux	Lichtfarbe Light color	DC-Motor DC-Engine	Leistung Motor Power Engine	Volumenstrom Volume flow
1 R64122106	incl. 1xSMD LED, 30 W	3.420 lm	2.700 - 6.500 K	✓	20 W	40 m ³ /min
2 R64122132	incl. 1xSMD LED, 30 W	3.420 lm	2.700 - 6.500 K	✓	20 W	40 m ³ /min





HALMSTAD

Kunststoff | plastic
Schwarz matt | black mat



10

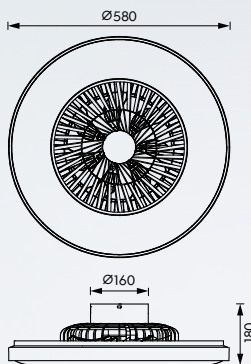

Art-Nr. Art. No.	Leuchtmittel Lamps	Leuchtenlichtstrom Luminous flux	Lichtfarbe Light color	DC-Motor DC-Engine	Leistung Motor Power Engine	Volumenstrom Volume flow
R62672132	incl. 1x SMD-LED, 38 W	4.400 lm	2.700 - 6.500 K	✓	15 W	33,24 m ³ /min



FLAGA

Kunststoff | plastic
Schwarz matt | black mat

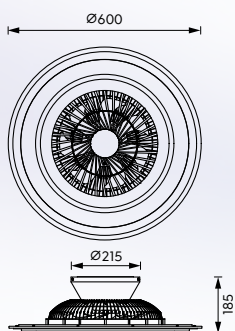

Art-Nr. Art. No.	Leuchtmittel Lamps	Leuchtenlichtstrom Luminous flux	Lichtfarbe Light color	DC-Motor DC-Engine	Leistung Motor Power Engine	Volumenstrom Volume flow
R62743132	incl. 1x SMD-LED, 35 W	4.100 lm	2.700 - 6.500 K	✓	15 W	33,24 m ³ /min



HARSTAD

Kunststoff | plastic
Chrom | chrome



12

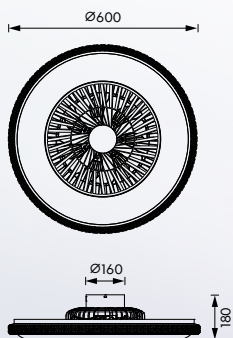

Art-Nr. Art. No.	Leuchtmittel Lamps	Leuchtenlichtstrom Luminous flux	Lichtfarbe Light color	DC-Motor DC-Engine	Leistung Motor Power Engine	Volumenstrom Volume flow
R62412106	incl. 1x SMD-LED, 38 W	4.400 lm	2.700 - 6.500 K	✓	15 W	33,24 m ³ /min





STRALSUND

Kunststoff | plastic
32 Schwarz matt | black mat
87 Titanfarbig | titan



14

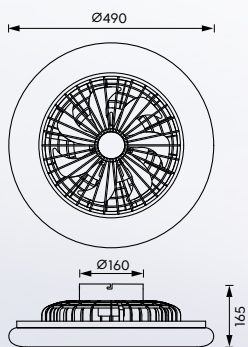

	Art-Nr. Art. No.	Leuchtmittel Lamps	Leuchtenlichtstrom Luminous flux	Lichtfarbe Light color	DC-Motor DC-Engine	Leistung Motor Power Engine	Volumenstrom Volume flow
1	R62522132	incl. 1x SMD-LED, 30 W	3.500 lm	2.700 - 6.500 K	✓	15 W	35,89 m ³ /min
2	R62522187	incl. 1x SMD-LED, 30 W	3.500 lm	2.700 - 6.500 K	✓	15 W	35,89 m ³ /min





STRALSUND

Kunststoff | plastic
Titanfarbig | titan

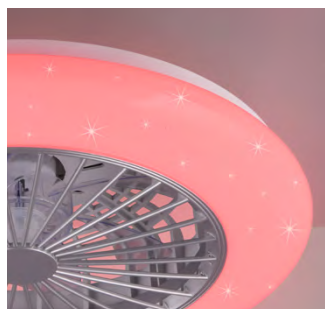

16

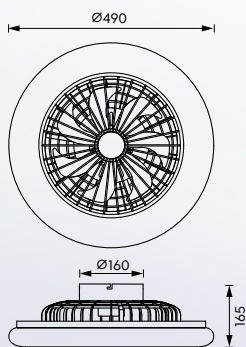

Art-Nr. Art. No.	Leuchtmittel Lamps	Leuchtenlichtstrom Luminous flux	Lichtfarbe Light color	DC-Motor DC-Engine	Leistung Motor Power Engine	Volumenstrom Volume flow
R62522987	incl. 1x SMD-LED, 30 W	3.500 lm	2.700 - 6.500 K	✓	15 W	35,89 m ³ /min





UMEA

Metall | metal
31 Weiß matt | white mat
06 Chrom | chrome



Oszillierend / Oscillating



18

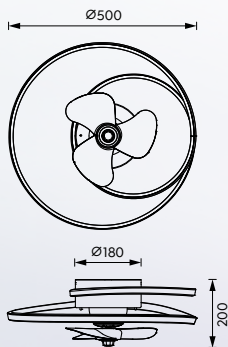

	Art-Nr. Art. No.	Leuchtmittel Lamps	Leuchtenlichtstrom Luminous flux	Lichtfarbe Light color	DC-Motor DC-Engine	Leistung Motor Power Engine	Volumenstrom Volume flow
1	R67252131	incl. 1x SMD-LED, 38 W	4.400 lm	2.700 - 6.500 K	✓	20 W	42,01 m ³ /min
2	R67262106	incl. 1x SMD-LED, 38 W	4.400 lm	2.700 - 6.500 K	✓	20 W	42,01 m ³ /min





NYBRO

Metall | metal
31 Weiß matt | white mat
32 Schwarz matt | black mat



1



2



Oszillierend / Oscillating

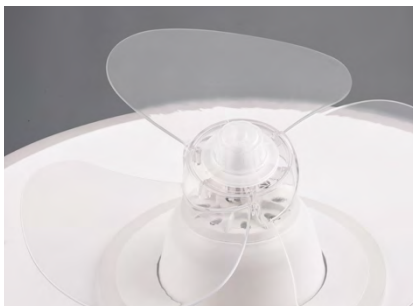

20

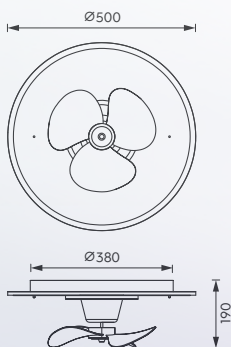

	Art-Nr. Art. No.	Leuchtmittel Lamps	Leuchtenlichtstrom Luminous flux	Lichtfarbe Light color	DC-Motor DC-Engine	Leistung Motor Power Engine	Volumenstrom Volume flow
1	R64133131	incl. 1x SMD-LED, 30 W	3.500 lm	2.700 - 6.500 K	✓	20 W	38,33 m ³ /min
2	R64133132	incl. 1x SMD-LED, 30 W	3.500 lm	2.700 - 6.500 K	✓	20 W	38,33 m ³ /min





BORGHOLM

Metall | metal

31 Weiß matt | white mat

32 Schwarz matt | black mat

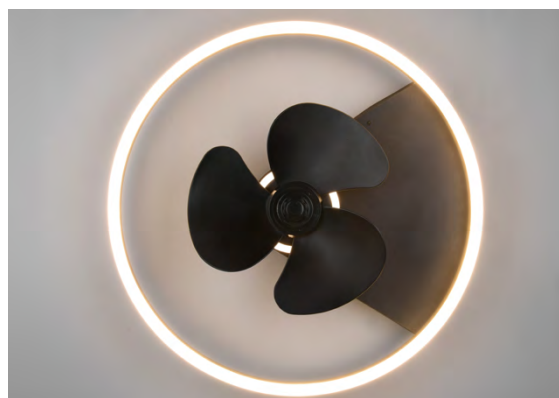

22

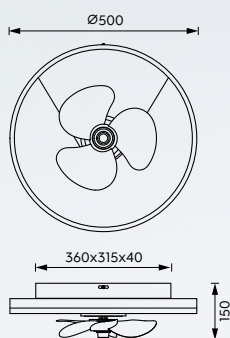

Art-Nr. Art. No.	Leuchtmittel Lamps	Leuchtenlichtstrom Luminous flux	Lichtfarbe Light color	DC-Motor DC-Engine	Leistung Motor Power Engine	Volumenstrom Volume flow
1 R67083131	incl. 1x SMD-LED, 30 W	3.500 lm	2.700 - 6.500 K		40 W	36 m ³ /min
2 R67083132	incl. 1x SMD-LED, 30 W	3.500 lm	2.700 - 6.500 K		40 W	36 m ³ /min



SORTLAND

Metall | metal
Schwarz matt | black mat

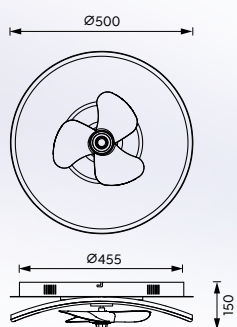

Art-Nr. Art. No.	Leuchtmittel Lamps	Leuchtenlichtstrom Luminous flux	Lichtfarbe Light color	DC-Motor DC-Engine	Leistung Motor Power Engine	Volumenstrom Volume flow
R67393132	incl. 1x SMD-LED, 30 W	3.500 lm	2.700 - 6.500 K	✓	15 W	32,43 m ³ /min



VARBERG

Kunststoff | plastic
Schwarz | black

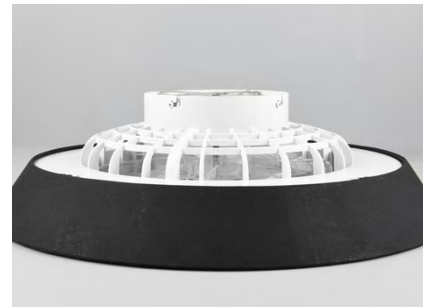

24

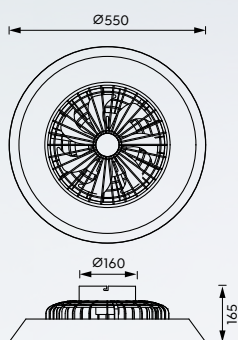

Art-Nr. Art. No.	Leuchtmittel Lamps	Leuchtenlichtstrom Luminous flux	Lichtfarbe Light color	DC-Motor DC-Engine	Leistung Motor Power Engine	Volumenstrom Volume flow
R67292102	incl. 1x SMD-LED, 30 W	3.500 lm	2.700 - 6.500 K	✓	15 W	35,89 m ³ /min



LINDBERG

Kunststoff | plastic
Titanfarbig | titan



Flügel ausfahrbar / Extendable sash

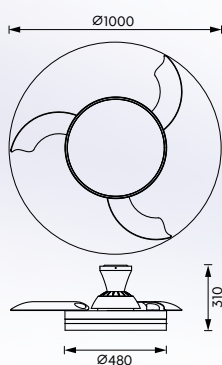

Art-Nr. Art. No.	Leuchtmittel Lamps	Leuchtenlichtstrom Luminous flux	Lichtfarbe Light color	DC-Motor DC-Engine	Leistung Motor Power Engine	Volumenstrom Volume flow
R67382187	incl. 1x SMD-LED, 35 W	4.050 lm	2.700 - 6.500 K	✓	25 W	126,32 m ³ /min



FARSUND

Kunststoff | plastic
01 Weiß | white
11 Grau | grey

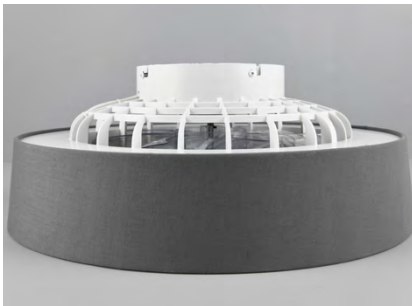

26

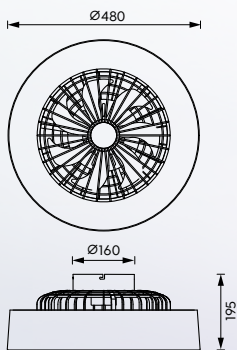

	Art-Nr. Art. No.	Leuchtmittel Lamps	Leuchtenlichtstrom Luminous flux	Lichtfarbe Light color	DC-Motor DC-Engine	Leistung Motor Power Engine	Volumenstrom Volume flow
1	R62662101	incl. 1x SMD-LED 30 W	3.500 lm	2.700 - 6.500 K	✓	15 W	35,89 m ³ /min
2	R62662111	incl. 1x SMD-LED 30 W	3.500 lm	2.700 - 6.500 K		40 W	35,89 m ³ /min





TRONDHEIM

Metall | metal
Schwarz matt | black mat



2



1



28

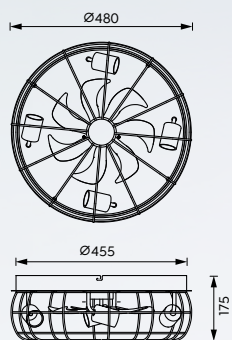

	Art-Nr. Art. No.	Leuchtmittel Lamps	Leuchtenlichtstrom Luminous flux	Lichtfarbe Light color	DC-Motor DC-Engine	Leistung Motor Power Engine	Volumenstrom Volume flow
1	R61095032	excl. 4x E27 max. 10 W*	470 lm	2.700 K		40 W	41,26 m ³ /min
2	R61105032	excl. 4x E27 max. 10 W*	470 lm	2.700 K	✓	15 W	41,26 m ³ /min

*Empfohlen/recommended: 987-400, Filament LED E27, 4 W, 470 lm, 2.700 K



LILLESAND

Papier | paper
Braun | brown

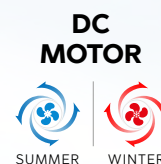
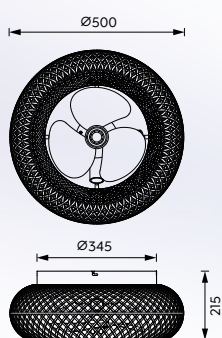

Art-Nr. Art. No.	Leuchtmittel Lamps	Leuchtenlichtstrom Luminous flux	Lichtfarbe Light color	DC-Motor DC-Engine	Leistung Motor Power Engine	Volumenstrom Volume flow
R67302126	excl. 4x E27, max. 10 W*	470 lm	3.000 K	✓	15 W	39,14 m ³ /min

*Empfohlen/recommended: **987-479**, Filament LED E27, 4 W, 470 lm, 3.000 K



KARLSBORG

Metall | metal
Schwarz matt | black mat



30

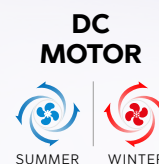
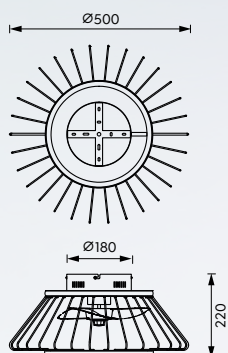

Art-Nr. Art. No.	Leuchtmittel Lamps	Leuchtenlichtstrom Luminous flux	Lichtfarbe Light color	DC-Motor DC-Engine	Leistung Motor Power Engine	Volumenstrom Volume flow
R67443132	incl. 1x SMD-LED, 30 W	3.500 lm	2.700 - 6.500 K	✓	15 W	32,43 m ³ /min



YSTAD

Metall | metal
Chrom | chrome



Oszillierend / Oscillating

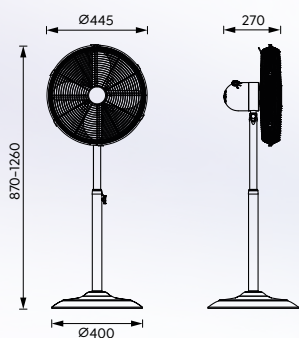

Art-Nr.
Art. No.

R037-06

Leistung Motor
Power Engine

50 W

Volumenstrom
Volume flow

66,83 m³/min



VIKING

Metall | metal
Schwarz matt | black mat



Oszillierend / Oscillating



32

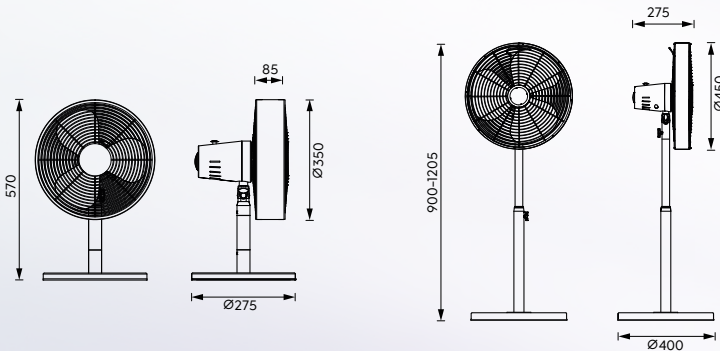

Art-Nr.
Art. No.

Leistung Motor
Power Engine

Volumenstrom
Volume flow

1 R035-32

35 W

36,13 m³/min

2 R034-32

50 W

64,91 m³/min





TROMSÖ

Metall | metal
Chrom | chrome

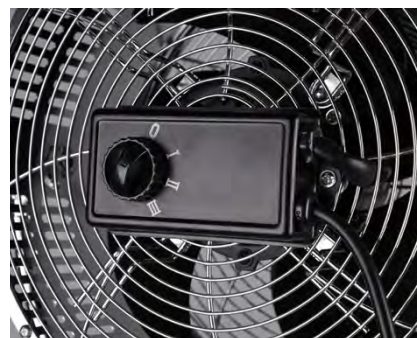

34

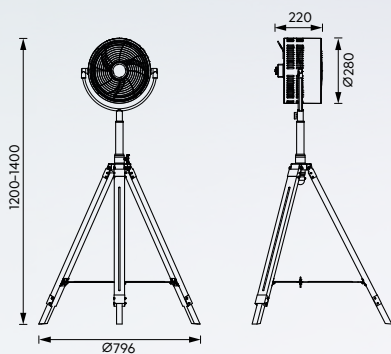

Art-Nr.
Art. No.

R036-06

Leistung Motor
Power Engine

70 W

Volumenstrom
Volume flow

53,51 m³/min



TEMPEST

Kunststoff | plastic
Weiß | white

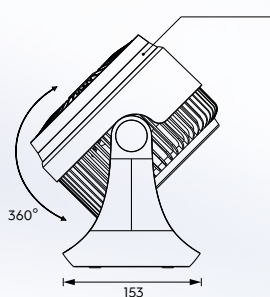
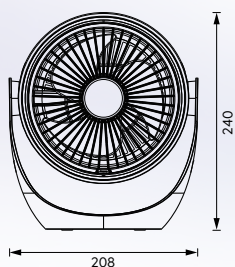
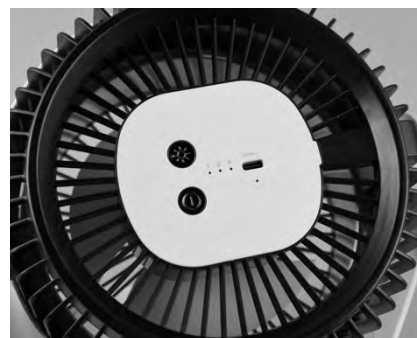

Ambientelicht / Ambience light

Art-Nr. Art. No.	Leuchtmittel Lamps	Leuchtenlichtstrom Luminous flux	Lichtfarbe Light color	Leistung Motor Power Engine	Volumenstrom Volume flow
R045-01	incl. 1x SMD-LED, 1 W	100 lm	6.500 K	4 W	1,2 m ³ /min



ICEBERG

Kunststoff | plastic
Weiß | white



Oszillierend / Oscillating

36

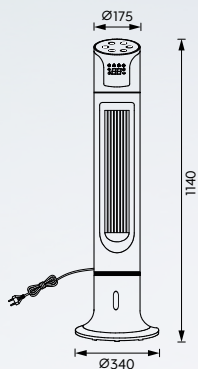

Art-Nr.
Art. No.

R039-01

Leistung Motor
Power Engine

60 W

Volumenstrom
Volume flow

14,5 m³/min



KALMAR

Kunststoff | plastic
Weiß | white



Oszillierend / Oscillating

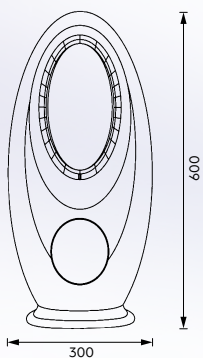

37

Art-Nr.
Art. No.

Leuchtmittel
Lamps

Leistung Motor
Power Engine

Volumenstrom
Volume flow

R043-01

incl. 1x SMD-LED 2 W

60 W

11,2 m³/min



BREEZY

Kunststoff | plastic

01 Weiß | white

02 Schwarz | black

49 Pistaziengrün | pistachio green

83 Illuminate Gelb | illuminate yellow



38

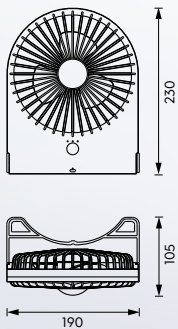

Art-Nr. Art. No.	Leistung Motor Power Engine	Volumenstrom Volume flow
R044-01	2 W	1,8 m ³ /min
R044-02	2 W	1,8 m ³ /min

Art-Nr. Art. No.	Leistung Motor Power Engine	Volumenstrom Volume flow
R044-49	2 W	1,8 m ³ /min
R044-83	2 W	1,8 m ³ /min





























INDEX

Art-Nr. Art.-No.	EAN	Familie Family	DC	Seite Page	Art-Nr. Art.-No.	EAN	Familie Family	DC	Seite Page
R62402106	4017807457766	VISBY		6	R034-32	4017807456806	VIKING		32
R62402906	4017807461084	VISBY	✓	6	R035-32	4017807456813	VIKING		32
R64122106	4017807564426	SANDEFJORD	✓	8	R036-06	4017807456820	TROMSÖ		34
R64122132	4017807564433	SANDEFJORD	✓	8	R037-06	4017807456837	YSTAD		31
R62672132	4017807491036	HALMSTAD	✓	10	R039-01	4017807456851	ICEBERG		36
R62743132	4017807495546	FLAGA	✓	11	R043-01	4017807491173	KALMAR		37
R62412106	4017807461206	HARSTAD	✓	12	R044-01	4017807564464	BREEZY		38
R62522132	4017807491098	STRALSUND	✓	14	R044-02	4017807564471	BREEZY		38
R62522187	4017807466157	STRALSUND	✓	14	R044-49	4017807564495	BREEZY		38
R62522987	4017807491128	STRALSUND	✓	16	R044-83	4017807564488	BREEZY		38
R67252106	4017807571271	UMEA	✓	18	R045-01	4017807609561	TEMPEST		35
R67252131	4017807571288	UMEA	✓	18	R61095032	4017807529562	TRONDHEIM		28
R64133131	4017807564440	NYBRO	✓	20	R61105032	4017807529586	TRONDHEIM	✓	28
R64133132	4017807564457	NYBRO	✓	20	R62402106	4017807457766	VISBY		6
R67083131	4017807529630	BORGHOLM		22	R62402906	4017807461084	VISBY	✓	6
R67083132	4017807529647	BORGHOLM		22	R62412106	4017807461206	HARSTAD	✓	12
R67393132	4017807606027	SORTLAND	✓	23	R62522132	4017807491098	STRALSUND	✓	14
R67292102	4017807605242	VARBERG	✓	24	R62522187	4017807466157	STRALSUND	✓	14
R67382187	4017807606119	LINDBERG	✓	25	R62522987	4017807491128	STRALSUND	✓	16
R62662101	4017807491074	FARSUND	✓	26	R62662101	4017807491074	FARSUND	✓	26
R62662111	4017807491081	FARSUND		26	R62662111	4017807491081	FARSUND		26
R61095032	4017807529562	TRONDHEIM		28	R62672132	4017807491036	HALMSTAD	✓	10
R61105032	4017807529586	TRONDHEIM	✓	28	R62743132	4017807495546	FLAGA	✓	11
R67302126	4017807605259	LILLESAND	✓	29	R64122106	4017807564426	SANDEFJORD	✓	8
R67443132	4017807609592	KARLSBORG	✓	30	R64122132	4017807564433	SANDEFJORD	✓	8
R037-06	4017807456837	YSTAD		31	R64133131	4017807564440	NYBRO	✓	20
R034-32	4017807456806	VIKING		32	R64133132	4017807564457	NYBRO	✓	20
R035-32	4017807456813	VIKING		32	R67083131	4017807529630	BORGHOLM		22
R036-06	4017807456820	TROMSÖ		34	R67083132	4017807529647	BORGHOLM		22
R045-01	4017807609561	TEMPEST		35	R67252106	4017807571271	UMEA	✓	18
R039-01	4017807456851	ICEBERG		36	R67252131	4017807571288	UMEA	✓	18
R043-01	4017807491173	KALMAR		37	R67292102	4017807605242	VARBERG	✓	24
R044-01	4017807564464	BREEZY		38	R67302126	4017807605259	LILLESAND	✓	29
R044-02	4017807564471	BREEZY		38	R67382187	4017807606119	LINDBERG	✓	25
R044-49	4017807564495	BREEZY		38	R67393132	4017807606027	SORTLAND	✓	23
R044-83	4017807564488	BREEZY		38	R67443132	4017807609592	KARLSBORG	✓	30

PRODUKTEIGENSCHAFTEN | FEATURES

-  Getrennt schaltbar | Separately switchable
 -  Fernbedienung | Remote control
 -  Integrierter Dimmer | Integrated dimmer
 -  Lichtfarbe stufenlos einstellbar | Light color infinitely variable
 -  Nachtlcht | Night Light
 -  Starlight Effekt | Starlight effect
 -  Ventilator | Fan
 -  3 Geschwindigkeitsstufen | 3 modes of speed
 -  6 Geschwindigkeitsstufen | 6 modes of speed
 -  Timer | Timer
 -  Sommer- und Winterbetrieb | Summer and winter operation
 -  WiZ Connected | WiZ Connected
 -  Memory Funktion | Memory function
 -  Musterschutz | Registered model
 -  RGBW Farbwechsler | RGBW Colorchanging
 -  Oszillierend | Oscillating
 -  Kippbar | Tilttable
 -  Höhenverstellbar | Adjustable height
 -  Inkl. Wassertank | incl. water tank
 -  Touch-Display | Touch display
 -  Raumbefeuchtung | Room humidification
-  USB-C Anschluss mit Ladefunktion | Recharging USB-C connection
 -  Sleep timer | Sleep timer
 -  Akkubetrieb | Rechargeable battery operated

Reality Leuchten GmbH

Gut Nierhof 17

D-59757 Arnsberg

T +49 2931 9666-99

F +49 2931 9666-98

info@reality-leuchten.de

www.reality-leuchten.de

DEUTSCHLAND

BADEN WÜRTTEMBERG,
RHEINLAND-PFALZ,
SAARLAND

Antonio De Simone

T +49 (0) 151 5855222

antonio.desimone@trio-leuchten.de

BAYERN, HESSEN

Martin Kluge

T +49 (0) 171 7300330

martin.kluge@trio-leuchten.de

BERLIN, BRANDENBURG,
MECKLENBURG-
VORPOMMERN, SACHSEN,
SACHSEN-ANHALT,
THÜRINGEN

Jörg Bumke

T +49 (0) 160 7406860

joerg.bumke@trio-leuchten.de

BREMEN, HAMBURG,
NIEDERSACHSEN,
SCHLESWIG-HOLSTEIN

Jens Gebers

T +49 (0) 170 1615227

jens.gebers@trio-leuchten.de

NORDRHEIN-WESTFALEN

Christian Teller

T +49 (0) 171 4521820

christian.teller@trio-leuchten.de

ÖSTERREICH

Wolfgang Melich

T +43 (0) 6605161228

wolfgang.melich@trio-leuchten.de

SCHWEIZ

TRIO Leuchten

T +49 (0) 2931 9666-0

info@trio-leuchten.de

 /trioleuchten

 @trio.lighting

 @trioleuchten

 @TRIO Lighting Group

 @trio Lighting

TRIO International GmbH

Gut Nierhof 17
D-59757 Arnsberg
T +49 2931 9666-587
F +49 2931 9666-56
info@trio-lighting.com
www.trio-lighting.com



www.trio-lighting.com

FRANCE

Stéphane Papierny
Directeur Commercial France
info.france@trio-lighting.com

Julien Lamouret
Product Manager France &
Sales Manager DIY France
info.france@trio-lighting.com

Jean Philippe Bailly
info.france@trio-lighting.com
*Agent exclusif pour les départements
60, 75 Nord, 92, 93 et 95*

Jean Barel / Bruno Rouquié
info.france@trio-lighting.com
*Agents exclusifs pour les départements
09, 12, 15, 16, 19, 24, 31, 32, 33, 40, 46,
47, 64, 65, 81, 82 et 87*

Jean Marc Beneforti
info.france@trio-lighting.com
*Agent exclusif pour les départements
2a et 2b*

Christophe Meulien
info.france@trio-lighting.com
*Agent exclusif pour les départements
04, 05, 06, 11, 13, 30, 34, 66, 83 et 84*

Sullivan Nicolas
info.france@trio-lighting.com
*Commercial pour les départements
01, 03, 07, 21, 23, 26, 38, 39, 42, 43, 48,
63, 69, 71, 73 et 74*

Stéphane Riebel
info.france@trio-lighting.com
*Agent exclusif pour les départements
18, 27, 28, 45, 58, 75 Sud, 76, 77,
78, 89, 91 et 94*

Michel Salamand
info.france@trio-lighting.com
*Agent exclusif pour les départements
14, 17, 22, 29, 35, 36, 37, 41, 44, 49, 50,
53, 56, 61, 72, 79, 85 et 86*

Vincent Zaepffel
info.france@trio-lighting.com
*Commercial pour les départements
02, 08, 10, 25, 51, 52, 54, 55, 57, 59, 62,
67, 68, 70, 80, 88 et 90*

DANMARK

Jan Rantzau-Bartens
info.denmark@trio-lighting.com

NORDIC & BALTIC

TRIO Lighting Scandinavia Oy
Malmin raitti, rappu 17 B
00700 Helsinki
T +358 (0) 10 23 13 390
tls@trio-lighting.com
*Our Scandinavian organisation represents
TRIO also in Sweden, Norway, Estonia, Latvia,
Lithuania and Iceland*

ITALIA

TRIO Lighting Italia s.r.l
Via Isonzo 81
22066 Mariano Comense (CO)
commerciale@trio-lighting.com

ESPAÑA

TRIO Lighting Ibèrica SL
C/ Can Lietget n°9 nave 9
Pol. Ind. Can Roqueta
08206 Sabadell
T +34 (0) 9 35 45 86 30
F +34 (0) 9 33 96 45 48
info.iberica@trio-lighting.com

GREAT BRITAIN

TRIO Lighting UK Ltd.
Unit 5, Hemmells Park Hemmells,
Laindon Essex
SS1s 6GF
T +44 (0) 12 68 88 95 95
F +44 (0) 12 68 88 95 96
sales@trio-lightinguk.com

NEDERLAND

Karl Stok / Bas Martin
info.nederland@trio-lighting.com

BELGIUM / BELGIQUE

Yves Van den Berghe
info.belgium@trio-lighting.com

ROMANIA

Loredana Barbu
info.romania@trio-lighting.com
loredana.barbu@trio-lighting.com

RL

live your light

Reality Leuchten GmbH

Gut Nierhof 17
D-59757 Arnsberg

T +49 2931 9666-99
F +49 2931 9666-98

info@reality-leuchten.de
www.reality-leuchten.de

TRIO International GmbH

Gut Nierhof 17
D-59757 Arnsberg

T +49 2931 9666-587
F +49 2931 9666-56

info@trio-lighting.com
www.trio-lighting.com