



 **TRIO**
LIGHTING FOR YOU

OUTDOOR
AUSSENLEUCHTEN | 2024
OUTDOOR LUMINAIRES

power efficiency. We hope you enjoy our new outdoor collection.

Dès que le soleil se couche, un éclairage extérieur innovant est indispensable. Un espace extérieur bien éclairé offre non seulement la sécurité, mais vous aide aussi à vous orienter et crée une agréable ambiance autour de votre maison. Les luminaires extérieurs doivent répondre à des exigences de qualité élevées afin de résister sans dommage aux aléas climatiques telles que l'humidité, la pluie, la neige et les variations saisonnières de température. Nos luminaires d'extérieur



Sobald die Sonne untergeht, darf eine innovative Außenbeleuchtung nicht fehlen. Ein gut beleuchteter Außenbereich bietet nicht nur Sicherheit, sondern dient der Orientierung und schafft Atmosphäre rund um Ihr zu Hause. Außenleuchten sollten hohe Qualitätsanforderungen erfüllen, um den unterschiedlichen Bedingungen wie Feuchtigkeit, Regen, Schnee sowie jahreszeitlich bedingten Temperaturschwankungen unbeschadet standzuhalten. Unsere Außenleuchten werden in hochwertigem Aluminium-Druckguss gefertigt und versprechen Betriebssicherheit während der gesamten Lebensdauer, bei jeder Witterung, 365 Tage im Jahr. Moderne LED-Technologie sorgt darüber hinaus für gute Beleuchtungsqualität und hohe Energieeffizienz. Wir wünschen Ihnen viel Freude mit unser neuen Outdoor-Kollektion.

As soon as the sun goes down innovative outside lighting is a must. Well lit outdoor areas do not only provide security, but are an orientation guide and create atmosphere around your home. Outdoor lighting should fulfil high quality standards to withstand diverse conditions such as dampness, rain, snow and seasonal variations in temperature. Our outdoor lamps are produced in high-quality diecast aluminium and promise operational reliability for their entire life cycle, in all weathers, 365 days a year. Modern LED technology also provides a high level of both light quality and

sont fabriqués en aluminium moulé sous pression de haute qualité et garantissent une sécurité de fonctionnement pendant toute leur durée de vie, par tous les temps, 365 jours par an. La technologie LED moderne assure en outre une bonne qualité d'éclairage et une haute efficacité énergétique. Nous vous souhaitons beaucoup de satisfaction avec notre nouvelle collection d'extérieur.

Zodra de zon ondergaat, mag een innovatieve buitenverlichting niet ontbreken. Een goed verlichte buitenzone biedt niet alleen veiligheid, maar is goed voor de oriëntatie en scheidt sfeer rond uw huis. Buitenlichten moeten voldoen aan hoge kwaliteitsvereisten om bestand te zijn tegen diverse omstandigheden zoals vocht, regen, sneeuw alsook van het seizoen afhingende temperatuurschommelingen. Onze buitenlichten worden uit hoogwaardig aluminium gegoten en beloven een veilige werking tijdens hun volledige levensduur, bij alle weersomstandigheden, 365 dagen per jaar. Moderne ledtechnologie zorgt daarnaast voor een goede verlichtingskwaliteit en hoge energie-efficiëntie. We wensen u veel plezier met onze nieuwe collectie voor buiten.

Tan pronto como se pone el sol, no debe faltar una iluminación exterior innovadora. Una zona exterior bien iluminada no solo ofrece seguridad, sino que también

sirve para orientarse y crean una atmósfera alrededor de tu casa. La iluminación exterior debe cumplir unos altos requisitos de calidad para soportar las diferentes condiciones de humedad, lluvia y nieve, así como las condiciones estacionales de oscilación de temperaturas. Nuestra iluminación exterior está fabricada en aluminio fundido a presión de alta calidad y aseguran la seguridad operativa durante toda su vida, en cualquier clima, 365 días al año. La moderna tecnología LED proporciona también una iluminación de buena calidad y una gran eficiencia energética. Le deseamos una gran satisfacción con nuestra nueva colección de exterior.



Non appena il sole tramonta, l'illuminazione esterna innovativa è un must. Un'area esterna ben illuminata non solo garantisce la sicurezza ma funge anche da mezzo di orientamento e crea una piacevole atmosfera intorno alla vostra casa. Le lampade per esterni devono soddisfare elevati requisiti in termini di qualità per resistere, senza subire danni, alle varie condizioni climatiche come umidità, pioggia, neve e fluttuazioni stagionali della temperatura. Le nostre lampade per esterni sono prodotte in alluminio pressofuso di alta qualità e garantiscono affidabilità operativa durante tutto il loro ciclo di vita, in qualsiasi condizione atmosferica, 365 giorni all'anno. La moderna tecnologia LED garantisce inoltre una buona qualità dell'illuminazione e un'elevata efficienza energetica. Vi auguriamo il massimo del piacere con la nostra nuova Collezione Outdoor.

De îndată ce soarele apune, un sistem inovator de iluminat exterior nu trebuie să lipsească. Un spațiu exterior bine iluminat nu oferă numai securitate, ci are și rolul de a asigura orientarea și de a crea o atmosferă plăcută în jurul casei. Lămpile exterioare trebuie să îndeplinească cerințe înalte de calitate, pentru a rezista fără deteriorări la acțiunea diferitelor condiții de mediu, precum umiditatea, ploaia, ninsoarea, precum și fluctuațiile sezoniere de temperatură. Lămpile noastre exterioare sunt produse din aluminiu turnat sub presiune

și garantează siguranța în operare pe parcursul întregii durate de exploatare, în orice condiții meteo, timp de 365 de zile pe an. Tehnologia LED modernă asigură suplimentar o calitate bună a iluminatului și o eficiență energetică înaltă. Vă dorim să vă bucurați de colecția noastră outdoor.

Kun aurinko laskee, ei innovatiiviseen ulkovalaistukseen pitäisi tarvita puuttua. Hyvin valaistu ulkoalue tarjoaa turvallisuuden lisäksi myös kulkureittien ohjausta ja luo tunnelmaa kodin ympärille. Ulkovalaisimien on täytettävä

korkeat laatuvaatimukset, jotta ne kestävät erilaisia olosuhteita, kuten kosteutta, sadetta, lunta ja vuodenaikojen lämpötilanvaihteluita ilman vaurioita. Ulkovalaisimet valmistetaan korkealaatuisesta painevalelusta alumiinista, ja ne takaavat varman toiminnan koko käyttöikänsä ajan säästä riippumatta, 365 päivää vuodessa. Moderni LED-tekniikka varmistaa myös hyvän valaistuksen laadun ja korkean energiatehokkuuden. Toivomme, että uusi ulkovalaisinmallistomme tuottaa sinulle paljon iloa.

Gdy tylko zachodzi słońce, nie powinno zabraknąć innowacyjnego oświetlenia zewnętrznego. Dobrze oświetlone miejsce na zewnątrz nie tylko zapewnia bezpieczeństwo, ale także służy orientacji w terenie i tworzy atmosferę wokół domu. Oświetlenie zewnętrzne powinno spełniać wysokie wymagania jakościowe, aby bez uszkodzeń sprostać różnym warunkom, tj. wilgoć, deszcz, śnieg i sezonowe wahania temperatury. Nasze lampy zewnętrzne są produkowane z wysokiej jakości odlewanej aluminium i zapewniają niezawodność działania przez cały okres użytkowania, bez względu na pogodę, 365 dni w roku. Nowoczesna technologia LED zapewnia również dobrą jakość oświetlenia i wysoką efektywność energetyczną. Życzymy Państwu wiele radości z korzystania z naszej nowej kolekcji oświetlenia zewnętrznego.



Serienübersicht · Family overview

Aperçu par famille · Overzicht per familie · Vista general por familia · Panoramica per famiglia ·
Prezentare pe familii de produse · Perheen yleiskuvaus · Przegląd rodziny



ADAJA	61	PECOS	49	ARUBA	166
ADOUR	62	PIAVE	53	BOLO	168
ARDAS	70	RENO	22	BONITO	132
ARDILA	78	RHINE	34	CALERA	141
AVISIO	64	ROYA	74	CAMARO	144
AVON	26	SALMON	20	CAMPUS	185
BELAJA	122	SAMBESI	102	CORDOBA	134
BELLY	66	SANTERNO	69	DORA	162
BREG	48	TANARO	111	ELLIOT	156
BRENTA	109	TAWA	67	ESQUEL	176
CAVADO	100	TAY	58	FERNANDEZ	154
CLYDE	68	THAMES	60	FOMOSA	178
COLORADO	59	THAMES II	56	FUNGO	150
COOPER	84	TIBER	72	GARCIA	181
CUANDO	42	TIMOK	50	JAMAICA	167
CUBANGO	98	TRENT	54	KENDAL	145
DAWSON	36	TUELA	113	LENNON	157
DUERO	112	TUNGA	73	LIMEIRA	137
ELVO	118	UBANGI	120	LORA	163
FUERTE	18	VOLTURNO	114	MARTINEZ	158
GANGES	24	WITHAM	16	MELO	186
GARONNE	82	YANGTZE	44	MENDOZA	178
HONDO	52			MINEROS	182
HOOSIC	86			MOLINA	136
HORTON	40			MORENA	143
HUDSON	96			PALMAS	164
INDUS	51			PALOMA	128
KANSAS	41			POSADAS	174
KASAI	47			PUELO	140
KAVERI	71			PUNO	138
KONDA	45			RICARDO	152
LIVENZA	116			ROSARIO	135
LUNGA	106			SALTA	179
MAREB	121			SANCHEZ	160
MARIZA	12			SANTANA	184
MARNE	38			SILVA	180
MAYENNE	55			SUAREZ	148
MERSEY	46			TORREZ	159
NELSON	32			VENADO	142
NESTOS	14				
NORMAN	108				
OHIO	43				
OLONA	110				
PEARL	28				

Produktübersicht · Product Overview

Aperçu des produits · Productoverzicht · Descripción del producto ·

Panoramica prodotto · Vizualizare produs · Tuotteen yleiskuvaus · Przegląd produktów



MARIZA
12



DAWSON
36



MARNE
38



AVON
26



FUERTE
18



RHINE
34



WITHAM
16



CALERA
141



PUELO
140



NELSON
32



GANGES
24



PEARL
30



TAWA
67



NESTOS
14



YANGTZE
44



CUANDO
42



HORTON
40



KANSAS
41



THAMES
60



THAMES II
56



SALMON
20



TRENT
54



ADOUR
62



COLORADO
59



TAY
58



SANTERO
69



MAYENNE
55



RENO
22

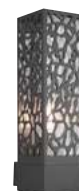

COOPER
84



CLYDE
68



ROYA
76



TIBER
72



KAVERI
71



TUNGA
73



ADAJA
61



CORDOBA
134



ROSARIO
135



ARDAS
70



AVISIO
64



PUNO
138



ARDILA
78



ARDILA
80



HOOSIC
92



HOOSIC
88



HUDSON
96



MOLINA
136



MOLINA
136



LIMEIRA
137



BONITO
132



PALOMA
130



GARONNE
82



INDUS
51



TIMOK
50



PECOS
49



KONDA
45



KENDAL
145



BELLY
66



HONDO
52



BREG
48



KENDAL
145



CAMARO
144



VENADO
142



MORENA
143



CUBANGO
98



TUELA
113



GARONNE
82

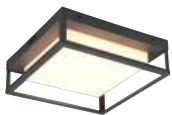

WITHAM
16



SAMBESI
102



TANARO
111



LUNGA
106



OLONA
110



CAVADO
100



DUERO
112



BRENTA
109



ELVO
118



VOLTURNO
114



LIVENZA
116



MARIZA
12



WITHAM
16



FUERTE
18



RHINE
34



PEARL
30



AVON
26



SALMON
20



ROYA
76



NELSON
32



KAVERI
71



GANGES
24



RENO
22



COOPER
84



HOOSIC
92



HOOSIC
88



PALOMA
130



ARDILA
80



ARDILA
78



GARONNE
82



HUDSON
96



SAMBESI
102



CUBANGO
98



CAVADO
100



ELVO
118



VOLTURNO
114



LIVENZA
116

Sicherheit & Komfort / Sensorleuchten · Security & Comfort / Sensor Lights

Sécurité et confort / Lampes à détecteur · Veiligheid en comfort/sensorlampen · Seguridad & Comodidad / Luces del sensor ·
Sicurezza e comfort / Lampade con sensore integrat · Siguranță & confort / Lumini senzor ·
Turvallisuus ja mukavuus/tunnistinvalaisimet · Bezpieczeństwo i komfort / światła z czujnikami



AVON
27



NESTOS
14



RHINE
34



GANGES
25



NELSON
33



PEARL
28



HORTON
41



ROYA
74



ROYA
74



TUNGA
73



CUANDO
42



OHIO
43



ADOUR
62



HOOSIC
90



HOOSIC
86



NORMAN
108



KASAI
47



PIAVE
53



NESTOS
14



ROYA
74



PEARL
28



HOOSIC
90



HOOSIC
86



PALOMA
128



GARONNE
83



GARONNE
83



SALMON
20



MARIZA
12



KANSAS
41



BONITO
132



PALOMA
128



SAMBESI
105



CAVADO
100



TUELA
113



LUNGA
106



MERSEY
46

Spots, Einbauleuchten & Zubehör ·

Spotlights, Recessed luminaires & Accessories

Spots, lumières encastrées et accessoires · Spots, inbouwlampen en toebehoren · Puntos de luz, lámparas integradas y accesorios · Faretto, lampade da incasso e sensori · Spoturi, lămpi încorporate & accesorii · Kohdevalaisimet, upotettavat valaisimet ja tarvikkeet · Spoty, światła wpuszczane i akcesoria



BELAJA
122



MAREB
121



UBANGI
120



ERDSPIESS
GROUND SPIKE
124



ECKHALTERUNG
CORNER FASTENING
125



STECKDOSEN
PLUG
123



STECKDOSEN
PLUG
123

Outdoor Living · Outdoor Living Lighting

Idées d'éclairage pour la vie en plein air · Lichtideeën voor buiten · Ideas de luz para la vida al aire libre · Idee di Illuminazione per l'Outdoor Living · Idei de iluminare pentru exterior · Outdoor Living -valaisinideat · Pomysły na oświetlenie zewnętrzne



ARUBA
166



JAMAICA
167



PALMAS
164



DORA
162



LORA
163



FUNGO
150



SUAREZ
148



TORREZ
159



RICARDO
152



ELLIOT
156



LENNON
157



SANCHEZ
160



FERNANDEZ
154



MARTINEZ
158



BOLO
170



BOLO
168

Solarleuchten · Solar Lights

Lampes solaires · Lampen op zonne-energie · Luces solares · Lampade solari · Lāmpi solare · Aurinkovalaisimet · Światła z zasilaniem słonecznym



POSADAS
174



ESQUEL
176



FOMOSA
178



MENDOZA
178



SALTA
179



POSADAS
174



ESQUEL
176



SILVA
180



GARCIA
181



MINEROS
182



SANTANA
184



MELO
186



CAMPUS
185

MARIZA

Aluminium Druckguss, Glas
 diecast aluminium, glass
 fonte d'aluminium, verre
 gegoten aluminium, glas
 aluminio fundido, vidrio
 pressofusione di alluminio, vetro
 fonta aluminiu, sticla
 valualumiini, lasi
 barwione aluminium, szkło

42 Anthrazit · anthracite

Incl. 1 x SMD-LED, 10 W
 1.100 lm, 3.000 K

247069142



Incl. 1 x SMD-LED, 10 W
 1.100 lm, 3.000 K

247060142

Incl. 1 x SMD-LED, 16 W
 1.800 lm, 3.000 K

447060142

Incl. 1 x SMD-LED, 11 W
 1.150 lm, 3.000 K

547060142

IP44



247069142



247060142



547060142



447060142

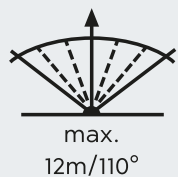
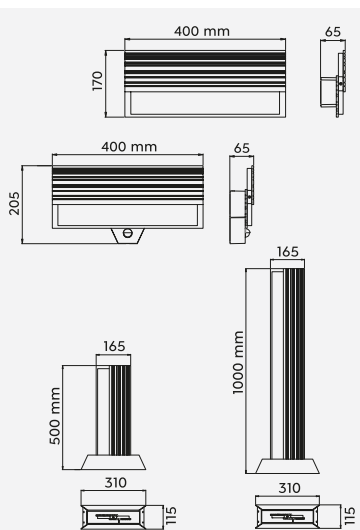

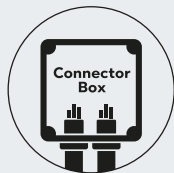

Inkl. Verbinder für Reihenschaltung.

Der Anschlusskasten dieser Leuchte ist für die Aufnahme von zwei Erdzu-
leitungen geeignet, um mehrere Leuchten in Reihenschaltung zu verbinden.

Connector for series connection included.

The connection box of this lighting fixture is fit for mounting two supply cables
in order to connect several luminaires in series.

NESTOS

Aluminium Druckguss, Kunststoff
 diecast aluminium, plastic
 fonte d'aluminium, plastique
 gegoten aluminium, kunststof
 aluminio fundido, plástico
 pressofusione di alluminio, plastica
 fonta aluminiu, plastic
 valualumiini, muovi
 barwione aluminium, plastik

42 Anthrazit · anthracite

Incl. 1 x SMD-LED, 13 W
 1.300 lm, 3.000 K

240960142

IP54

Incl. 1 x SMD-LED, 13 W
 1.300 lm, 3.000 K

240969142

440969142

540969142

IP54



240960142



240969142



440969142



540969142

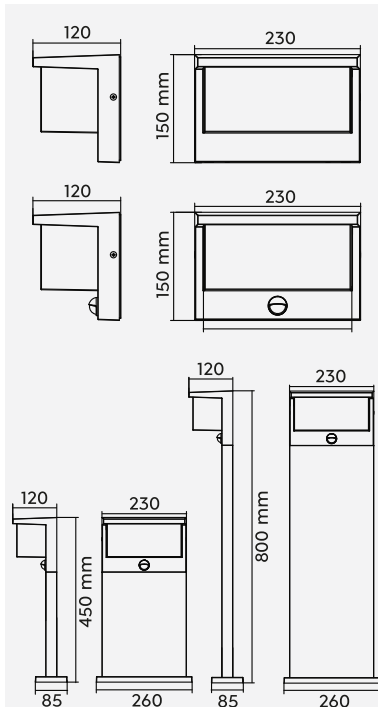

max.
 8m/120°





Aluminium Druckguss
diecast aluminium
fonte d'aluminium
gegooten aluminium
aluminio fundido
pressofusione di alluminio
fonta aluminiu
valualumiini
barwione aluminium

42 Anthrazit · anthracite

Incl. 1 x SMD-LED, 10,5 W
1.100 lm, 2.300 + 3.000 + 4.000 K
277860142

Incl. 1 x SMD-LED, 14 W
1.550 lm, 2.300 + 3.000 + 4.000 K
677860142



Incl. 1 x SMD-LED, 14,5 W
1.450 lm, 2.300 + 3.000 + 4.000 K
477860142
577860142



677860142



277860142



477860142



577860142

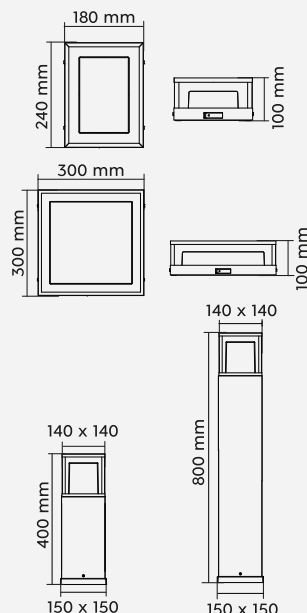

DIP SWITCH

Lichtfarben direkt an der Leuchte einstellbar

Colours directly adjustable at the lamp

Les couleurs de la lumière peuvent être réglées directement sur le luminaire

Lichtkleuren direct instelbaar op de lamp

Tonalidades de luz ajustables directamente en la lámpara

Colori della luce regolabili direttamente sulla lampada

Colori ale luminii reglabile direct de la bec

Valon väri asetettävissa suoraan valaisimesta

Barwy światła można ustawić bezpośrednio na oprawie

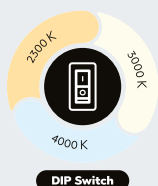

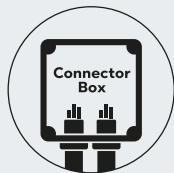

Inkl. Verbinder für Reihenschaltung.

Der Anschlusskasten dieser Leuchte ist für die Aufnahme von zwei Erdzu-
leitungen geeignet, um mehrere Leuchten in Reihenschaltung zu verbinden.

Connector for series connection included.

The connection box of this lighting fixture is fit for mounting two supply cables
in order to connect several luminaires in series.

FUERTE

Aluminium Druckguss, Acryl
diecast aluminium, acryl
fonte d'aluminium, acryl
gegoten aluminium, acryl
aluminio fundido, acrílico
pressofusione di alluminio, acrilico
fonta aluminiu, acrilic
valualumiini, akryyli
barwione aluminium, akryl

42 Anthrazit · anthracite

Incl. 1 x SMD-LED, 10,5 W
1.300 lm, 3.000 K

226260142

IP54

Incl. 1 x SMD-LED, 15 W
1.700 lm, 3.000 K

426260142

526260142

IP54



226260142



426260142



526260142

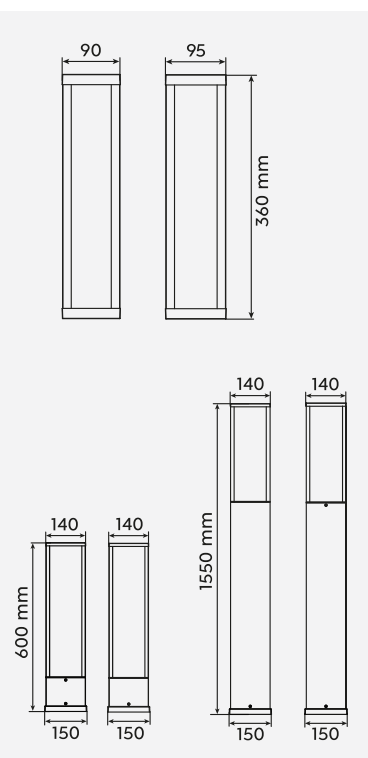



222

SALMON

Aluminium Druckguss,
Holznachbildung
diecast aluminium, wood imitation
fonte d'aluminium, imitation bois
gegoten aluminium, houtimitatie
aluminio fundido,
imitación de madera
pressofusione di alluminio,
effetto legno
fonta aluminiu, imitație de lemn
valualumiini, puujäljitelmä
barwione aluminium,
imitacja drewna

35 Holznachbildung / Anthrazit ·
wood imitation / anthracite

Incl. 1 x SMD-LED, 11 W
1.200 lm, 3.000 K

246969135



Incl. 1 x SMD-LED, 11 W
1.200 lm, 3.000 K

246960135

446960135

546960135

IP44

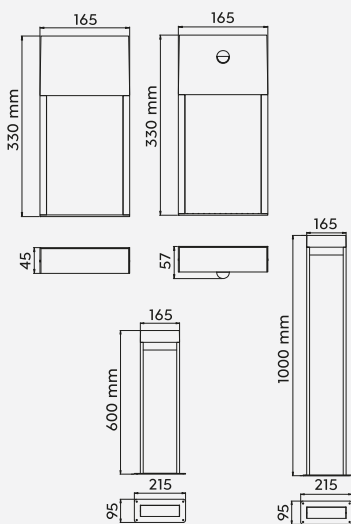

246960135



246969135



546960135



446960135

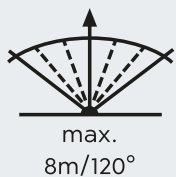

Bewegungssensor
Motion sensor
Détecteur de mouvement
Bewegungssensor
Sensor de movimiento
Sensore di movimento
Senzor de mișcare
Liiketunnistin
Czujnik ruchu



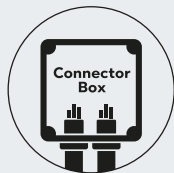

Inkl. Verbinder für Reihenschaltung.

Der Anschlusskasten dieser Leuchte ist für die Aufnahme von zwei Erdzu-
leitungen geeignet, um mehrere Leuchten in Reihenschaltung zu verbinden.

Connector for series connection included.

The connection box of this lighting fixture is fit for mounting two supply cables
in order to connect several luminaires in series.

RENO

Aluminium Druckguss
diecast aluminium
fonte d'aluminium
gegoten aluminium
aluminio fundido
pressofusione di alluminio
fonta aluminu
valualumiini
barwione aluminium

42 Anthrazit · anthracite

Incl. 1 x COB-LED, 4,5 W
450 lm, 3.000 K

IP54

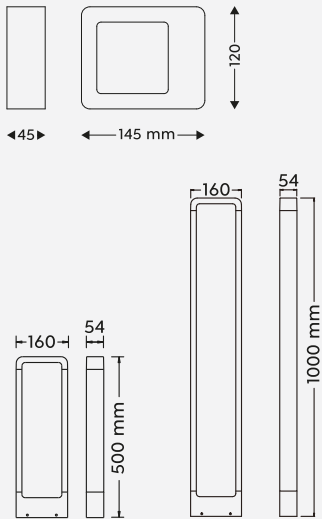

220760142



520760142



420760142

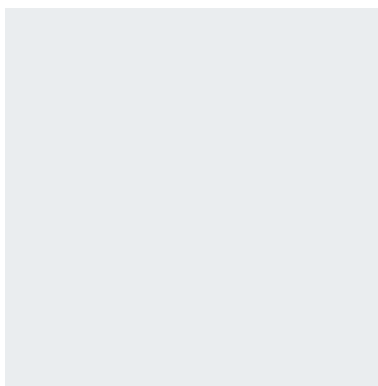



GANGES

Aluminium Druckguss
diecast aluminium
fonte d'aluminium
gegoten aluminium
aluminio fundido
pressofusione di alluminio
fonta aluminii
valualumiini
barwione aluminium

42 Anthrazit · anthracite

Incl. 1 x SMD-LED, 9 W
1.000 lm, 3.000 K

IP54

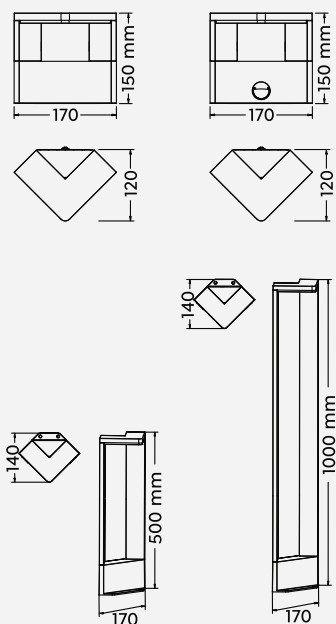

221760142



521760142



421760142





221769142



Bewegungssensor
Motion sensor
Détecteur de mouvement
Bewegungssensor
Sensor de movimiento
Sensore di movimento
Senzor de mişcare
Liiketunnistin
Czujnik ruchu

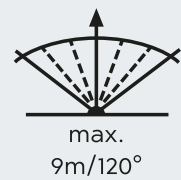

AVON

Aluminium Druckguss, Acryl
 diecast aluminium, acryl
 fonte d'aluminium, acryl
 gegoten aluminium, acryl
 aluminio fundido, acrílico
 pressofusione di alluminio, acrilico
 fonta aluminiu, acrilic
 valualumiini, akryyli
 barwione aluminium, akryl

42 Anthrazit · anthracite

Incl. 1 x SMD-LED, 7 W
 800 lm, 3.000 K

270660142

470660142

570660142



Incl. 2 x SMD-LED, 7 W
 2 x 800 lm, 3.000 K

270660242



270660142



270660242



570660142



470660142

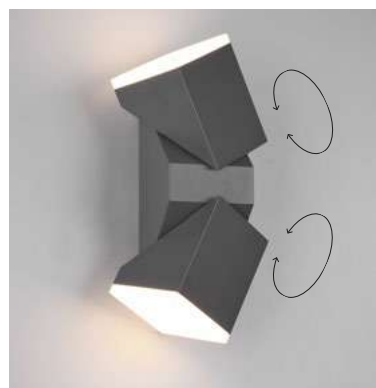
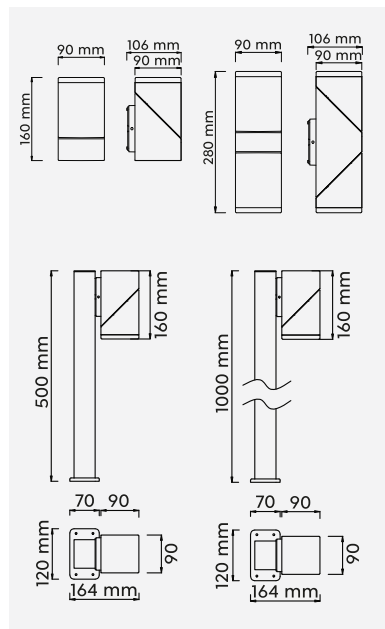



Aluminium Druckguss, Acryl
 diecast aluminium, acryl
 fonte d'aluminium, acryl
 gegoten aluminium, acryl
 aluminio fundido, acrílico
 pressofusione di alluminio, acrilico
 fonta aluminiu, acrilic
 valualumiini, akryyli
 barwione aluminium, akryl

42 Anthrazit · anthracite

Incl. 1 x SMD-LED, 7 W
 800 lm, 3.000 K
270669142



Incl. 2 x SMD-LED, 7 W
 2 x 800 lm, 3.000 K
270669242



270669242

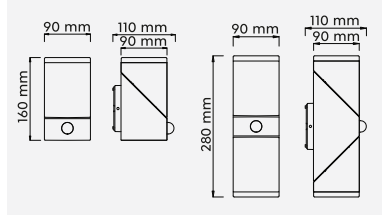

270669142



Die Leuchte verfügt über ein Orientierungslicht, das sich bei Dämmerung oder Dunkelheit automatisch einschaltet. Wird eine Bewegung erfasst, schaltet die Leuchte von Orientierungslicht auf volle Lichtleistung.

The luminaire has an orientation light that switches on automatically at dusk or in the dark. If movement is detected, the luminaire switches from orientation light to full light output.

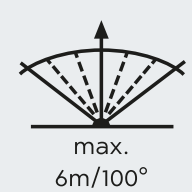

PEARL

Aluminium Druckguss, Kunststoff
 diecast aluminium, plastic
 fonte d'aluminium, plastique
 gegoten aluminium, kunststof
 aluminio fundido, plástico
 pressofusione di alluminio, plastica
 fonta aluminiu, plastic
 valualumiini, muov
 barwione aluminium, plastik

42 Anthrazit · anthacite

Incl. 1 x SMD-LED, 8 W
 900 lm, 3.000 K



221169142



521169142



421169142

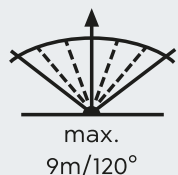
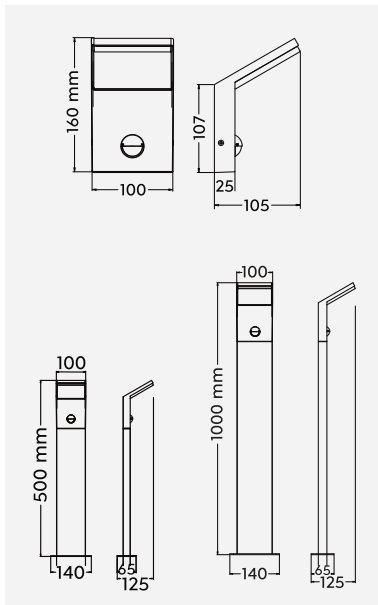

Bewegungssensor
 Motion sensor
 Détecteur de mouvement
 Bewegungssensor
 Sensor de movimiento
 Sensore di movimento
 Senzor de mişcare
 Liiketunnistin
 Czujnik ruchu





PEARL

Aluminium Druckguss, Kunststoff
diecast aluminium, plastic
fonte d'aluminium, plastique
gegoten aluminium, kunststof
aluminio fundido, plástico
pressofusione di alluminio, plastica
fonta aluminiu, plastic
valualumiini, muovi
barwione aluminium, plastik

42 Anthrazit · anthacite

Incl. 1 x SMD-LED, 8 W
900 lm, 3.000 K

IP54

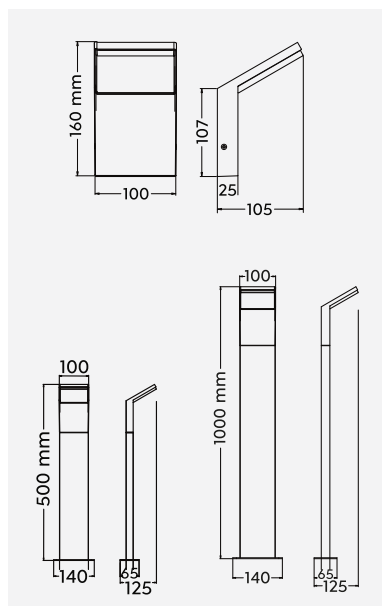

221160142



521160142



421160142





NELSON

Aluminium Druckguss
 diecast aluminium
 fonte d'aluminium
 gegoten aluminium
 aluminio fundido
 pressofusione di alluminio
 fonta aluminiu
 valualumiini
 barwione aluminium

42 Anthrazit · anthracite

Incl. 1 x SMD-LED, 8 W
 900 lm, 3.000 K

IP54

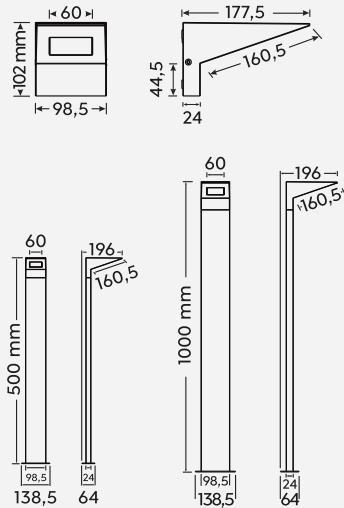

225360142



525360142



425360142

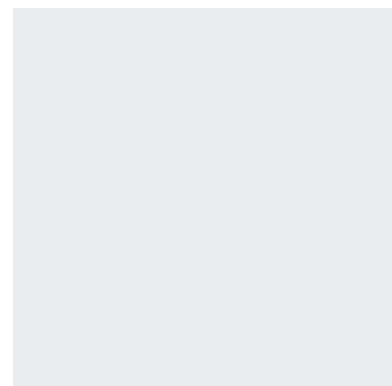

NELSON

Aluminium Druckguss
diecast aluminium
fonte d'aluminium
gegooten aluminium
aluminio fundido
pressofusione di alluminio
fonta aluminiu
valualumiini
barwione aluminium

42 Anthrazit · anthracite

Incl. 1 x SMD-LED, 8 W
900 lm, 3.000 K

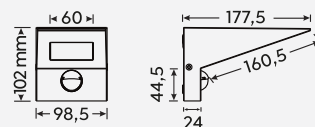

225369142



Bewegungssensor
Motion sensor
Décteur de mouvement
Bewegingssensor
Sensor de movimiento
Sensore di movimento
Senzor de mişcare
Liiketunnistin
Czujnik ruchu

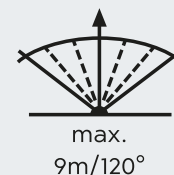

RHINE

Aluminium Druckguss, Kunststoff
 diecast aluminium, plastic
 fonte d'aluminium, plastique
 gegoten aluminium, kunststof
 aluminio fundido, plástico
 pressofusione di alluminio, plastica
 fonta aluminiu, plastic
 valualumiini, muov
 barwione aluminium, plastik

42 Anthrazit · anthracite

Incl. 2 x SMD-LED, 4,5 W
 2 x 450 lm, 3.000 K

221660242

221669242

Incl. 2 x SMD-LED, 5,5 W
 2 x 700 lm, 3.000 K

421660242

521660242

IP54



221669242



221660242



521660242



421660242

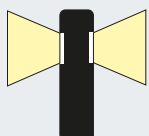
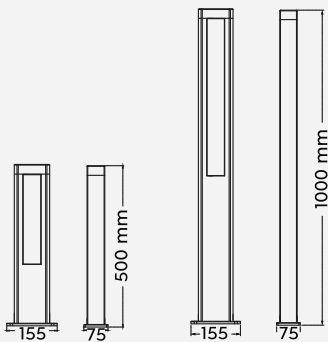
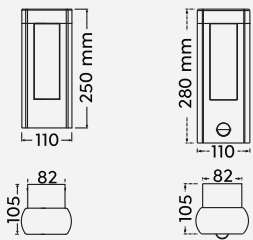



Bewegungssensor
Motion sensor
Décteur de mouvement
Bewegungssensor
Sensor de movimiento
Sensore di movimento
Senzor de mişcare
Liiketunnistin
Czujnik ruchu

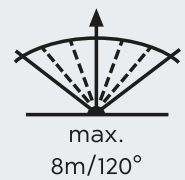

DAWSON

Aluminium Druckguss, Acryl
diecast aluminium, acryl
fonte d'aluminium, acryl
gegoten aluminium, acryl
aluminio fundido, acrílico
pressofusione di alluminio, acrilico
fonta aluminiu, acrilic
valualumiini, akryyli
barwione aluminium, akryl

42 Anthrazit · anthracite

Incl. SMD-LED, 7 W
800 lm, 2.300 + 3.000 + 4.000 K
246360142

Incl. SMD-LED, 8 W
900 lm, 2.300 + 3.000 + 4.000 K
246360242

Incl. SMD-LED, 11 W
1.300 lm, 2.300 + 3.000 + 4.000 K
246360342

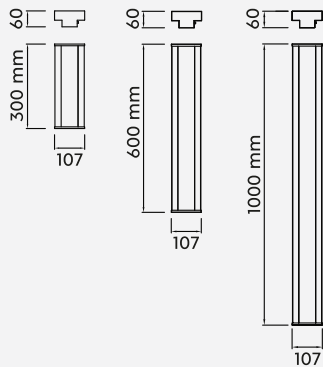

246360142



246360342



246360242

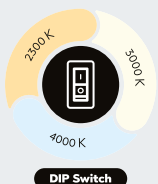

DIP SWITCH

Lichtfarben direkt an der Leuchte einstellbar

Colours directly adjustable at the lamp

Les couleurs de la lumière peuvent être réglées directement sur le luminaire

Lichtkleuren direct instelbaar op de lamp

Tonalidades de luz ajustables directamente en la lámpara

Colori della luce regolabili direttamente sulla lampada

Colori ale luminii reglabile direct de la bec

Valon väri asetettävissa suoraan valaisimesta

Barwy światła można ustawić bezpośrednio na oprawie



MARNE

Aluminium Druckguss, Acryl
diecast aluminium, acryl
fonte d'aluminium, acryl
gegoten aluminium, acryl
aluminio fundido, acrílico
pressofusione di alluminio, acrilico
fonta aluminiu, acrilic
valualumiini, akryyli
barwione aluminium, akryl

42 Anthrazit · anthracite

Incl. SMD-LED, 5,5 W
600 lm, 3.000 K

247360142

Incl. SMD-LED, 8,5 W
1.000 lm, 3.000 K

247360242

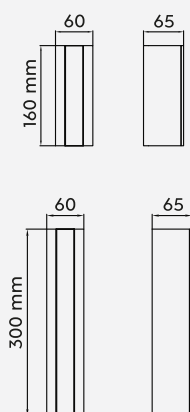

247360142



247360242





HORTON

Aluminium Druckguss
 diecast aluminium
 fonte d'aluminium
 gegoten aluminium
 aluminio fundido
 pressofusione di alluminio
 fonta aluminiu
 valualumiini
 barwione aluminium

42 Anthrazit · anthracite

Incl. 1 x SMD-LED, 8 W
 1.000 lm, 3.000 K

226360142



Incl. 1 x SMD-LED, 8 W
 1.000 lm, 3.000 K

226369142

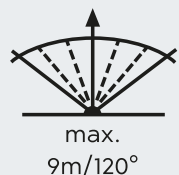
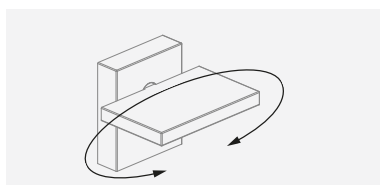
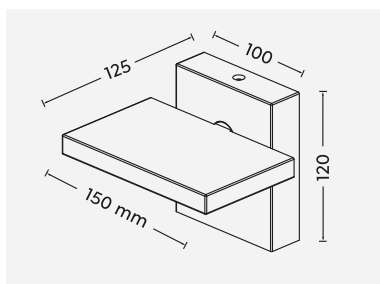

Bewegungssensor
 Motion sensor
 Détecteur de mouvement
 Bewegungssensor
 Sensor de movimiento
 Sensore di movimento
 Senzor de mişcare
 Liiketunnistin
 Czujnik ruchu



KANSAS



Aluminium Druckguss, Acryl
diecast aluminium, acryl
fonte d'aluminium, acryl
gegoten aluminium, acryl
aluminio fundido, acrílico
pressofusione di alluminio, acrilico
fonta aluminiu, acrilic
valualumiini, akryyli
barwione aluminium, akryl

42 Anthrazit · anthracite

Incl. 1 x SMD-LED, 10 W
1.000 lm, 3.000 K

246860142



Incl. 1 x SMD-LED, 10 W
1.000 lm, 3.000 K

246869142

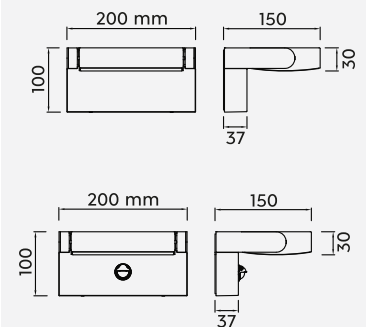

246860142



Bewegungssensor
Motion sensor
Détecteur de mouvement
Bewegingssensor
Sensor de movimiento
Sensore di movimento
Senzor de mişcare
Liiketunnistin
Czujnik ruchu

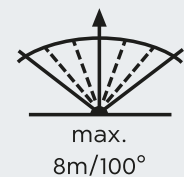

CUANDO

Aluminium Druckguss, Acryl
diecast aluminium, acryl
fonte d'aluminium, acryl
gegoten aluminium, acryl
aluminio fundido, acrílico
pressofusione di alluminio, acrilico
fonta aluminiu, acrilic
valualumiini, akryyli
barwione aluminium, akryl

42 Anthrazit · anthracite

Incl. SMD-LED, 11 W
1.400 lm, 3.000 K

226660242



Incl. SMD-LED, 11 W
1.400 lm, 3.000 K

226669242

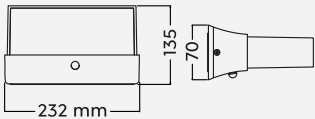
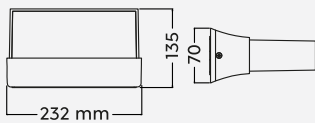

226660242



226669242

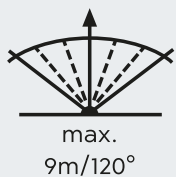

Bewegungssensor
Motion sensor
Détecteur de mouvement
Bewegungssensor
Sensor de movimiento
Sensore di movimento
Senzor de mișcare
Liiketunnistin
Czujnik ruchu



Aluminium Druckguss, Kunststoff
 diecast aluminium, plastic
 fonte d'aluminium, plastique
 gegoten aluminium, kunststof
 aluminio fundido, plástico
 pressofusione di alluminio, plastica
 fonta aluminiu, plastic
 valualumiini, muovi
 barwione aluminium, plastik

42 Anthrazit · anthracite

Incl. 1 x SMD-LED, 7,5 W
 800 lm, 3.000 K

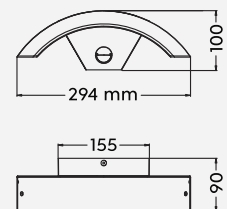

220969142



Bewegungssensor
 Motion sensor
 Détecteur de mouvement
 Bewegungssensor
 Sensor de movimiento
 Sensore di movimento
 Senzor de mişcare
 Liiketunnistin
 Czujnik ruchu

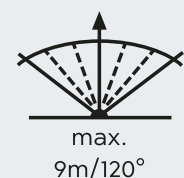

YANGTZE

Aluminium Druckguss, Kunststoff
diecast aluminium, plastic
fonte d'aluminium, plastique
gegoten aluminium, kunststof
aluminio fundido, plástico
pressofusione di alluminio, plastica
fonta aluminiu, plastic
valualumiini, muovi
barwione aluminium, plastik

42 Anthrazit · anthracite

Incl. 1 x SMD-LED, 4,5 W
400 lm, 3.000 K

IP54

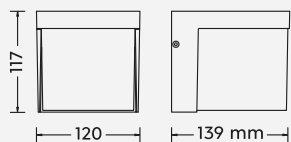

228260142



KONDA

Aluminium Druckguss, Kunststoff
diecast aluminium, plastic
fonte d'aluminium, plastique
gegoten aluminium, kunststof
aluminio fundido, plástico
pressofusione di alluminio, plastica
fonta aluminiu, plastic
valualumiini, muovi
barwione aluminium, plastik

42 Anthrazit · anthracite

Incl. 1 x SMD-LED, 9 W
1.200 lm, 3.000 K

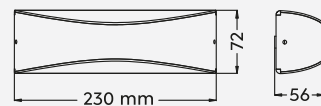

228560242



MERSEY

Aluminium Druckguss, Kunststoff
diecast aluminium, plastic
fonte d'aluminium, plastique
gegoten aluminium, kunststof
aluminio fundido, plástico
pressofusione di alluminio, plastica
fonta aluminiu, plastic
valualumiini, muov
barwione aluminium, plastik

42 Anthrazit · anthracite

Excl. 2 x E14, max. 40 W

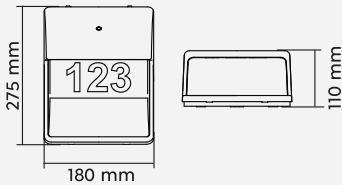

212160242



Empfohlen:
recommended:

LED E14, 3,5 W
320 lm, 3.000 K



983-40



Dämmerungssensor
Dusk sensor
Décteur de crépuscule
Schemeringsensor
Sensor de oscuridad
Sensore crepuscolare
Senzor de lumina/amurg
Hämäretunnistin
Czujnik zmierzchowy

KASAI

Aluminium Druckguss, Kunststoff
diecast aluminium, plastic
fonte d'aluminium, plastique
gegooten aluminium, kunststof
aluminio fundido, plástico
pressofusione di alluminio, plastica
fonta aluminiu, plastic
valualumiini, muovi
barwione aluminium, plastik

42 Anthrazit · anthracite

Incl. 1 x SMD-LED, 9 W
850 lm, 3.000 K

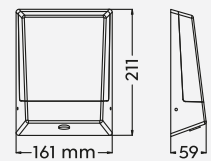

228669142



Dämmerungssensor
Dusk sensor
Décteur de crépuscule
Schemeringsensor
Sensor de oscuridad
Sensore crepuscolare
Sensor de lumina/amurg
Hämärätunnistin
Czujnik zmierzchowy
Alacakaranlık Algılayıcısı

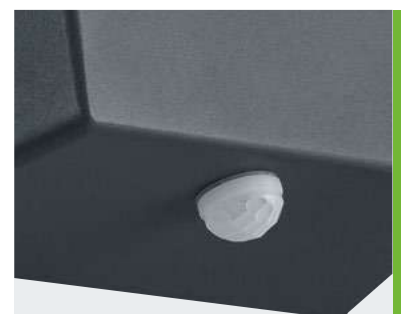

BREG

Aluminium Druckguss, Kunststoff
diecast aluminium, plastic
fonte d'aluminium, plastique
gegoten aluminium, kunststof
aluminio fundido, plástico
pressofusione di alluminio, plastica
fonta aluminiu, plastic
valualumiini, muovi
barwione aluminium, plastik

42 Anthrazit · anthracite

Incl. 1 x SMD-LED, 8,5 W
850 lm, 3.000 K

IP54

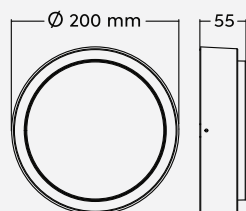

227260142



PECOS

Aluminium Druckguss, Kunststoff
diecast aluminium, plastic
fonte d'aluminium, plastique
gegooten aluminium, kunststof
aluminio fundido, plástico
pressofusione di alluminio, plastica
fonta aluminii, plastic
valualumiini, muovi
barwione aluminium, plastik

42 Anthrazit · anthracite

Incl. 1 x SMD-LED, 6 W
600 lm, 3.000 K

IP54

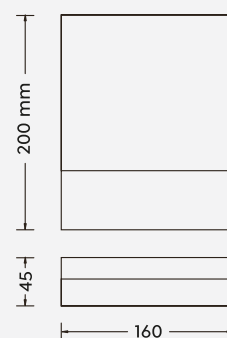

227760142

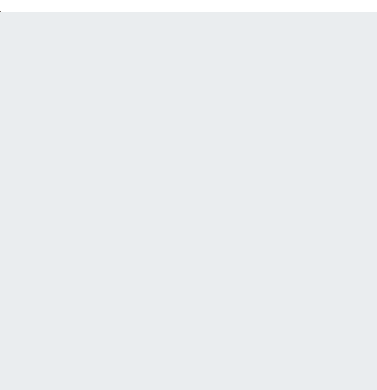

TIMOK

Aluminium Druckguss, Kunststoff
diecast aluminium, plastic
fonte d'aluminium, plastique
gegoten aluminium, kunststof
aluminio fundido, plástico
pressofusione di alluminio, plastica
fonta aluminiu, plastic
valualumiini, muovi
barwione aluminium, plastik

42 Anthrazit · anthracite

Incl. 1 x LED E27, 4,9 W
470 lm, 3.000 K

IP54

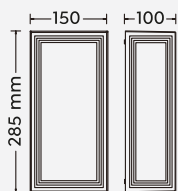

228060142



INDUS

Aluminium Druckguss, Kunststoff
diecast aluminium, plastic
fonte d'aluminium, plastique
gegoten aluminium, kunststof
aluminio fundido, plástico
pressofusione di alluminio, plastica
fonta aluminiu, plastic
valualumiini, muovi
barwione aluminium, plastik

42 Anthrazit · anthracite

Incl. 2 x SMD-LED, 4 W
2 x 500 lm, 3.000 K

IP54

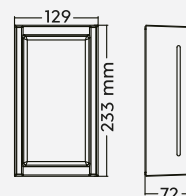

227360142



HONDO

Aluminium Druckguss, Kunststoff
diecast aluminium, plastic
fonte d'aluminium, plastique
gegoten aluminium, kunststof
aluminio fundido, plástico
pressofusione di alluminio, plastica
fonta aluminiu, plastic
valualumiini, muovi
barwione aluminium, plastik

42 Anthrazit · anthracite

Incl. 1 x SMD-LED, 3,5 W
330 lm, 3.000 K

IP54

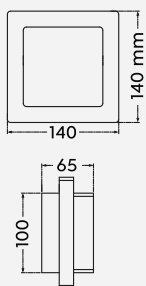

228960142



PIAVE



Kunststoff
plastic
plastique
kunststof
plástico
plastica
plastic
muovi
plastik

31 Weiß matt · white mat

42 Anthrazit · anthracite

Incl. SMD-LED, 11 W
1.180 lm, 3.000 K

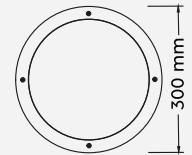

676960131



676960142



Bewegungssensor
Motion sensor
Détecteur de mouvement
Bewegingssensor
Sensor de movimiento
Sensore di movimento
Senzor de mișcare
Liiketunnistin
Czujnik ruchu



max.
10m/150°

TRENT

Aluminium Druckguss
diecast aluminium
fonte d'aluminium
gegoten aluminium
aluminio fundido
pressofusione di alluminio
fonta aluminiu
valualumiini
barwione aluminium

31 Weiß matt · white mat

42 Anthrazit · anthracite

Incl. SMD-LED, 9 W
1.100 lm, 3.000 K

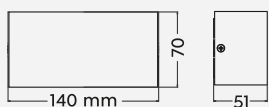

226960231



226960242

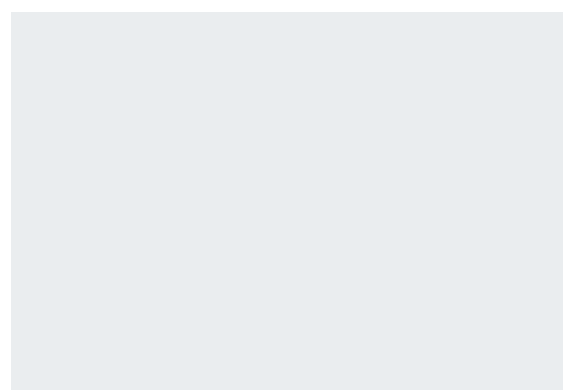

MAYENNE

Aluminium Druckguss, Acryl
diecast aluminium, acryl
fonte d'aluminium, acryl
gegoten aluminium, acryl
aluminio fundido, acrílico
pressofusione di alluminio, acrilico
fonta aluminiu, acrilic
valualumiini, akryyli
barwione aluminium, akryl

35 Holznachbildung · wood imitation

42 Anthrazit · anthracite

Excl. 2 x E14, max. 28 W

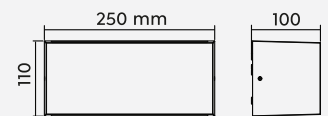

218560242



218560235



THAMES II

Aluminium Druckguss
diecast aluminium
fonte d'aluminium
gegoten aluminium
aluminio fundido
pressofusione di alluminio
fonta aluminii
valualumiini
barwione aluminium

31 Weiß matt · white mat

42 Anthrazit · anthracite

Incl. 2 x SMD-LED, 2,5 W
2 x 260 lm, 3.000 K

227560231

227560242

Incl. 2 x SMD-LED, 4,5 W
2 x 450 lm, 3.000 K

227660231

227660242

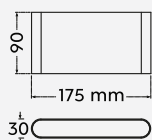
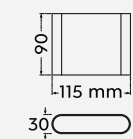

227560231



227560242



227660231



227660242



THAMES II

Aluminium Druckguss
diecast aluminium
fonte d'aluminium
gegoten aluminium
aluminio fundido
pressofusione di alluminio
fonta aluminiu
valualumiini
barwione aluminium

31 Weiß matt · white mat

42 Anthrazit · anthracite

Incl. 2 x SMD-LED, 8 W
2 x 800 lm, 3.000 K

226460231

226460242

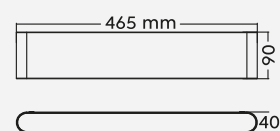

226460231



226460242



TAY

Aluminium Druckguss
diecast aluminium
fonte d'aluminium
gegoten aluminium
aluminio fundido
pressofusione di alluminio
fonta aluminiu
valualumiini
barwione aluminium

42 Anthrazit · anthracite

Incl. 2 x SMD-LED, 4,5 W
2 x 580 lm, 3.000 K

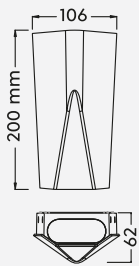

226560242



COLORADO

Aluminium Druckguss
diecast aluminium
fonte d'aluminium
gegoten aluminium
aluminio fundido
pressofusione di alluminio
fonta aluminiu
valualumiini
barwione aluminium

42 Anthrazit · anthracite

Incl. 2 x SMD-LED, 3 W
2 x 300 lm, 3.000 K

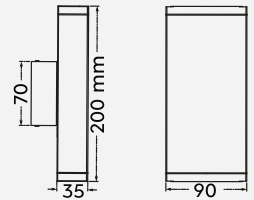

228460242

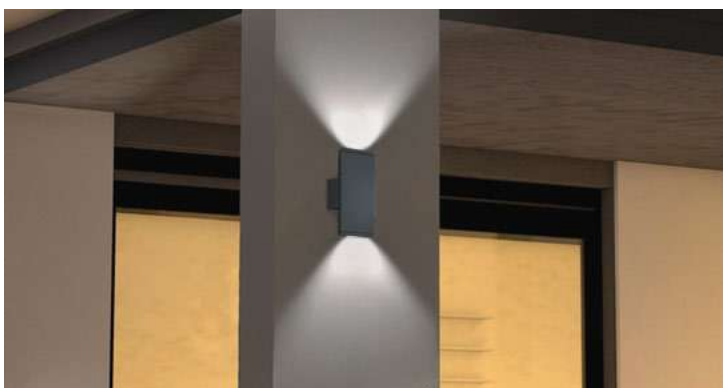

THAMES

Aluminium Druckguss
diecast aluminium
fonte d'aluminium
gegoten aluminium
aluminio fundido
pressofusione di alluminio
fonta aluminiu
valualumiini
barwione aluminium

42 Anthrazit · anthracite

Incl. 2 x SMD-LED, 3 W
2 x 340 lm, 3.000 K

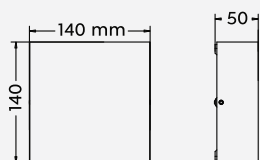

229360242



ADAJA



Aluminium Druckguss
diecast aluminium
fonte d'aluminium
gegoten aluminium
aluminio fundido
pressofusione di alluminio
fonta aluminiu
valualumiini
barwione aluminium

42 Anthrazit · anthracite

Incl. 2 x SMD-LED, 3 W
2 x 350 lm, 3.000 K

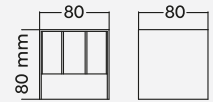

226860242



ADOUR

Aluminium Druckguss, Acryl
 diecast aluminium, acryl
 fonte d'aluminium, acryl
 gegoten aluminium, acryl
 aluminio fundido, acrílico
 pressofusione di alluminio, acrilico
 fonta aluminiu, acrilic
 valualumiini, akryyli
 barwione aluminium, akryl

31 Weiß matt · white mat

42 Anthrazit · anthracite

Incl. 1 x SMD-LED, 7,5 W
 750 lm, 2.300 + 3.000 + 4.000 K

245560131

245560142



Incl. 1 x SMD-LED, 7,5 W
 750 lm, 2.300 + 3.000 + 4.000 K

245569131

245569142



245560131



245560142



245569131



245569142

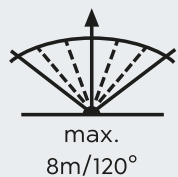
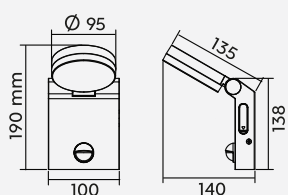
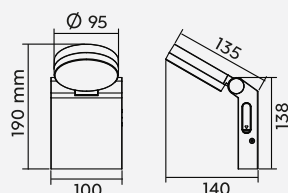



DIP SWITCH

Lichtfarben direkt an der Leuchte einstellbar

Colours directly adjustable at the lamp

Les couleurs de la lumière peuvent être réglées directement sur le luminaire

Lichtkleuren direct instelbaar op de lamp

Tonalidades de luz ajustables directamente en la lámpara

Colori della luce regolabili direttamente sulla lampada

Culori ale luminii reglabile direct de la bec

Valon väri asetettävissa suoraan valaisimesta

Barwy światła można ustawić bezpośrednio na oprawie

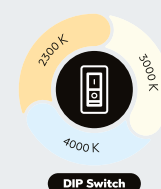

AVISIO

Aluminium Druckguss, Kunststoff
diecast aluminium, plastic
fonte d'aluminium, plastique
gegoten aluminium, kunststof
aluminio fundido, plástico
pressofusione di alluminio, plastica
fonta aluminiu, plastic
valualumiini, muovi
barwione aluminium, plastik

31 Weiß matt · white mat

32 Schwarz matt · black mat

Incl. 2 x SMD-LED, 2 W
2 x 250 lm, 3.000 K

246760231

246760232

Incl. 4 x SMD-LED, 2 W
4 x 250 lm, 3.000 K

646760431

646760432

IP54



246760231



246760232



246760431



246760432

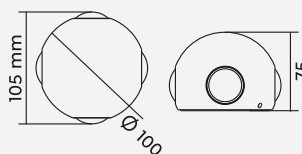
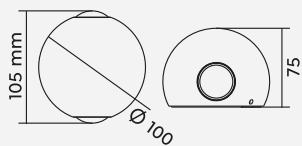



BELLY

Aluminium Druckguss
diecast aluminium
fonte d'aluminium
gegoten aluminium
aluminio fundido
pressofusione di alluminio
fonta aluminiu
valualumiini
barwione aluminium

42 Anthrazit · anthracite

Incl. 1 x SMD-LED, 8,5 W
850 lm, 3.000 K

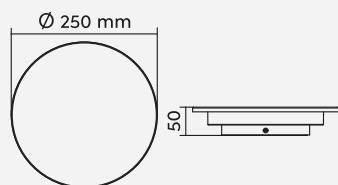

240660142

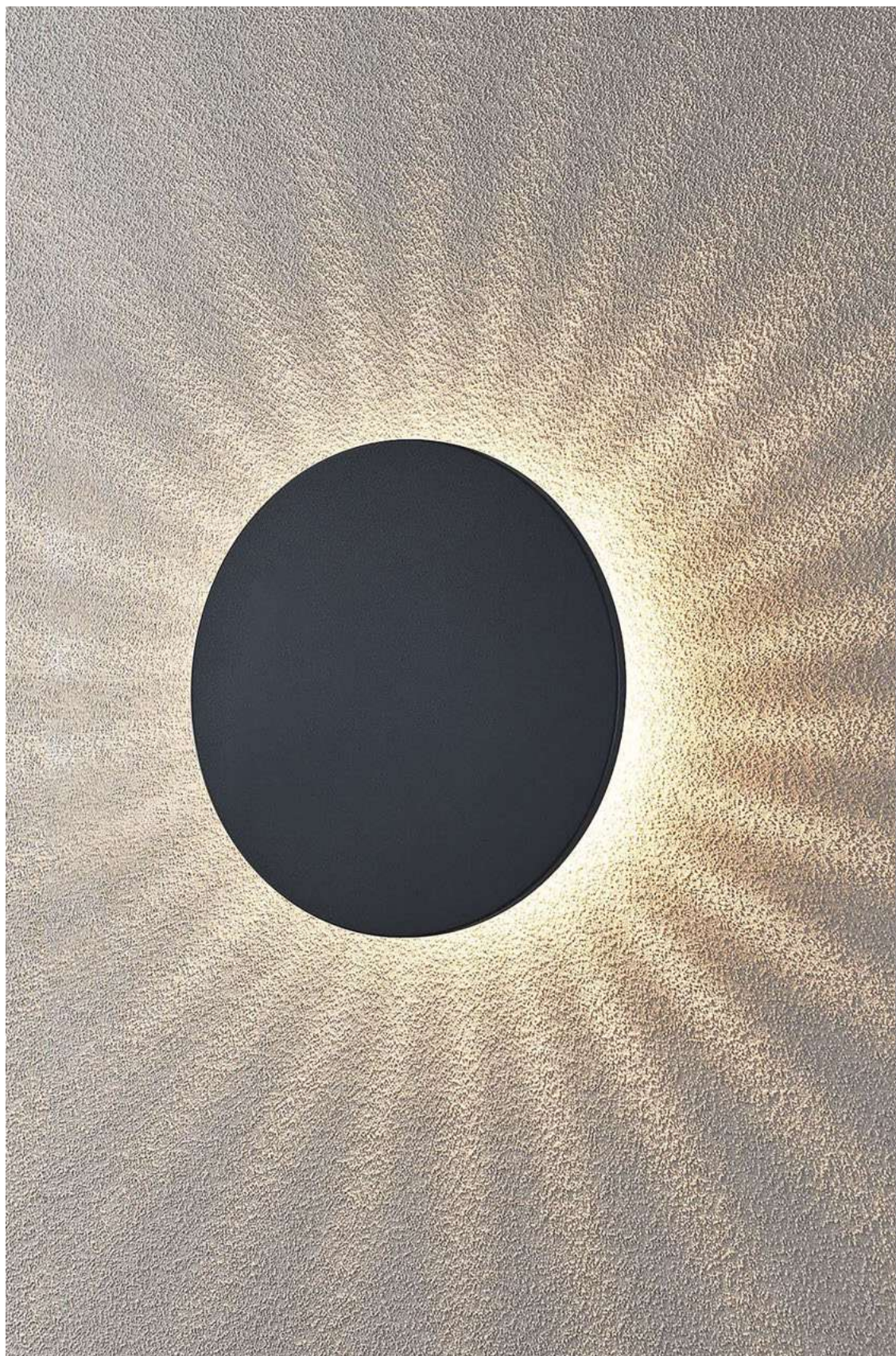

Aluminium Druckguss
 diecast aluminium
 fonte d'aluminium
 gegoten aluminium
 aluminio fundido
 pressofusione di alluminio
 fonta aluminiu
 valualumiini
 barwione aluminium

42 Anthrazit · anthracite

Incl. 1 x SMD-LED, 7,5 W
 800 lm, 3.000 K

221460142

Incl. 2 x SMD-LED, 9 W
 2 x 900 lm, 3.000 K

221460242

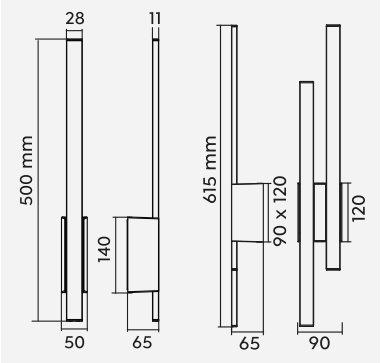

221460142

221460242



CLYDE

Aluminium Druckguss
diecast aluminium
fonte d'aluminium
gegoten aluminium
aluminio fundido
pressofusione di alluminio
fonta aluminiu
valualumiini
barwione aluminium

42 Anthrazit · anthracite

Incl. 2 x SMD-LED, 3 W
2 x 300 lm, 3.000 K

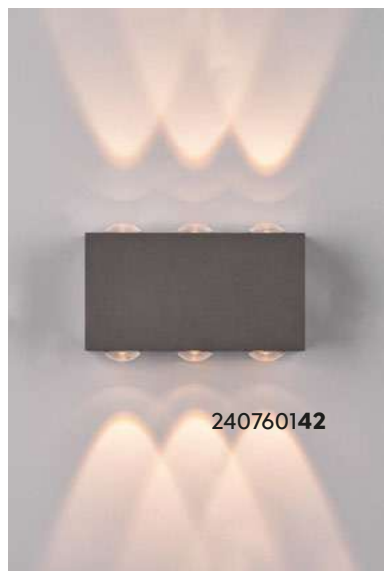
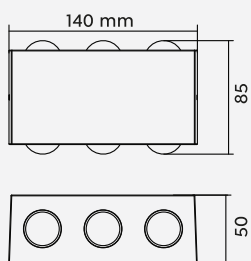



Aluminium Druckguss
 diecast aluminium
 fonte d'aluminium
 gegoten aluminium
 aluminio fundido
 pressofusione di alluminio
 fonta aluminiu
 valualumiini
 barwione aluminium

42 Anthrazit · anthracite

Incl. 1 x SMD-LED, 7,5 W
 850 lm, 2.300 + 3.000 + 4.000 K

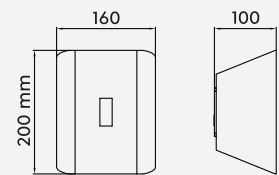

DIP SWITCH

Lichtfarben direkt an der Leuchte einstellbar

Colours directly adjustable at the lamp

Les couleurs de la lumière peuvent être réglées directement sur le luminaire

Lichtkleuren direct instelbaar op de lamp

Tonalidades de luz ajustables directamente en la lámpara

Colori della luce regolabili direttamente sulla lampada

Culori ale luminii reglabile direct de la bec

Valon väri asetettavissa suoraan valaisimesta

Barwy światła można ustawić bezpośrednio na oprawie

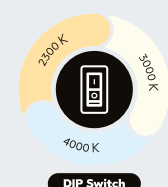

ARDAS

Aluminium Druckguss, Glas
diecast aluminium, glass
fonte d'aluminium, verre
gegoten aluminium, glas
aluminio fundido, vidrio
pressofusione di alluminio, vetro
fonta aluminiu, sticla
valualumiini, lasi
barwione aluminium, szkło

- 24** rostfarbig · rusty
- 31** Weiß matt · white mat
- 32** Schwarz matt · black mat

Excl. 2 x GU10, max. 10 W

212560224

212560231

212560232

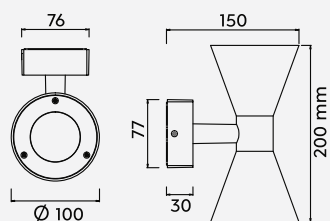

212560232

Empfohlen:
recommended:

LED GU10, 5 W
400 lm, 3.000 K
≥ 110°



955-50



212560224



212560231

KAVERI

Aluminium Druckguss
 diecast aluminium
 fonte d'aluminium
 gegoten aluminium
 aluminio fundido
 pressofusione di alluminio
 fonta aluminiu
 valualumiini
 barwione aluminium

42 Anthrazit · anthracite

Excl. 1 x GU10, max. 5 W



IP44

506060142

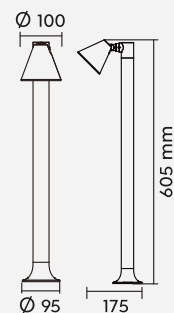
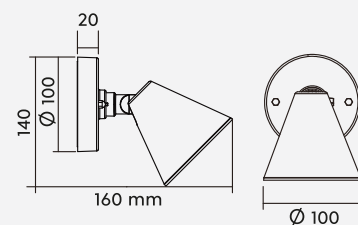

206060142



Empfohlen:
 recommended:

LED GU10, 5 W
 400 lm, 3.000 K
 ≥ 110°



955-50

TIBER

Aluminium Druckguss
diecast aluminium
fonte d'aluminium
gegoten aluminium
aluminio fundido
pressofusione di alluminio
fonta aluminii
valualumiini
barwione aluminium

42 Anthrazit · anthracite

Incl. 1 x SMD-LED, 3 W
300 lm, 3.000 K

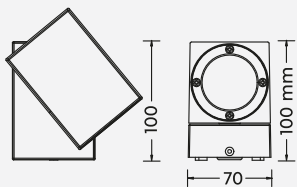

229160142

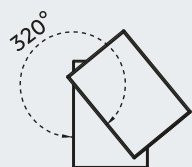

TUNGA

Aluminium Druckguss
 diecast aluminium
 fonte d'aluminium
 gegoten aluminium
 aluminio fundido
 pressofusione di alluminio
 fonta aluminii
 valualumiini
 barwione aluminium

42 Anthrazit · anthracite

Incl. 2 x COB-LED, 3,5 W
 2 x 420 lm, 3.000 K
222960242

IP54

Incl. 2 x COB-LED, 3,5 W
 2 x 420 lm, 3.000 K
222969242

IP54



222969242

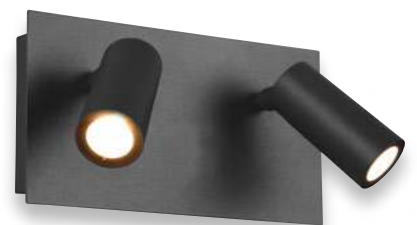
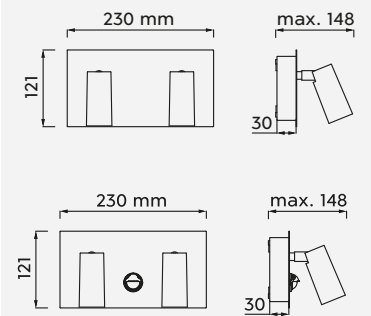

222960242

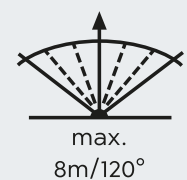

Aluminium Druckguss
 diecast aluminium
 fonte d'aluminium
 gegoten aluminium
 aluminio fundido
 pressofusione di alluminio
 fonta aluminiu
 valualumiini
 barwione aluminium

42 Anthrazit · anthracite

Excl. 1 x GU10, max. 35 W

214260142
214269142
414260142
514260142



Excl. 2 x GU10, max. 35 W

214260242
214269242



214260142

214260242

214269242

214269142



514260142

414260142

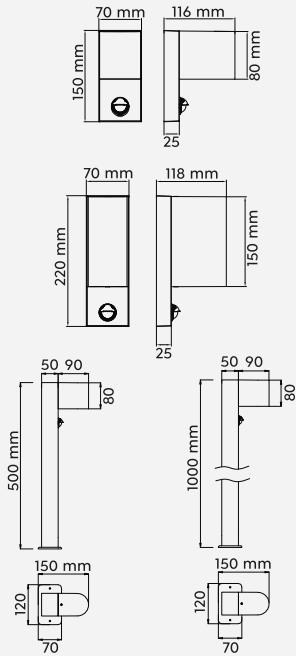

Empfohlen:
 recommended:

LED GU10, 5 W
 400 lm, 3.000 K
 ≈ 110°

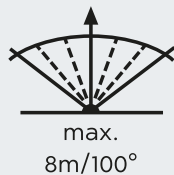

Bewegungssensor
 Motion sensor
 Détecteur de mouvement
 Bewegungssensor
 Sensor de movimiento
 Sensore di movimento
 Senzor de mișcare
 Liiketunnistin
 Czujnik ruchu

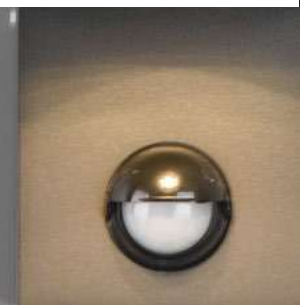



Aluminium Druckguss
 diecast aluminium
 fonte d'aluminium
 gegoten aluminium
 aluminio fundido
 pressofusione di alluminio
 fonta aluminiu
 valualumiini
 barwione aluminium

- 24** rostfarbig · rusty
- 31** Weiß matt · white mat
- 42** Anthrazit · anthracite

Excl. 2 x GU10, max. 35 W

- 204260224**
- 204269224**
- 204260231**
- 204269231**
- 204260242**
- 204269242**



Excl. 1 x GU10, max. 20 W

- 404260142**
- 504260142**



204260242



204269242



504260142



404260142

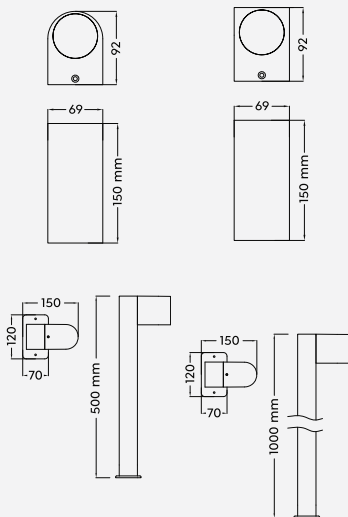

Empfohlen:
 recommended:

LED GU10, 5 W
 400 lm, 3.000 K
 > 110°



955-50



204260224



204260231

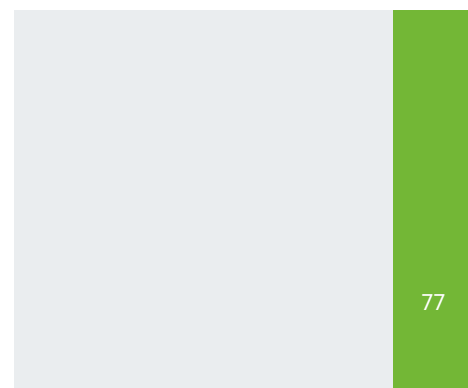

ARDILA

Aluminium Druckguss, Glas
diecast aluminium, glass
fonte d'aluminium, verre
gegoten aluminium, glas
aluminio fundido, vidrio
pressofusione di alluminio, vetro
fonta aluminiu, sticla
valualumiini, lasi
barwione aluminium, szkło

35 Holznachbildung · wood imitation

Excl. 1 x E27, max. 20 W

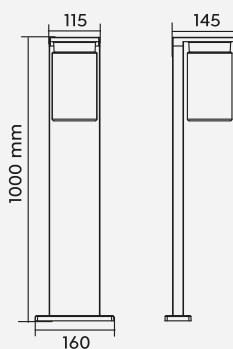
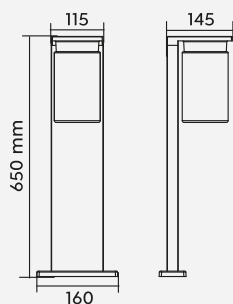
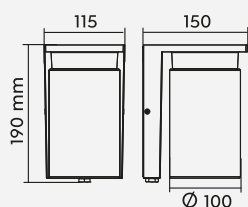

211660135



511660135



411660135

Empfohlen:
recommended:

Filament LED
E27, 4 W
470 lm, 2.700 K



987-400



Dämmerungssensor per Schalter deaktivierbar

On and off switchable dusk sensor

Décteur de crépuscule commutable

Aan en uit schakelbare schemeringsensor

Sensor de oscuridad conmutable on/off

Sensore crepuscolare commutabile on/off

senzor de lumina/amurg on/off

On/off kytkettävä hämärätunnistin

Czujnik zmierzchowy dezaktywowany przez przełącznika

Aç-kapa anahtarlı karanlık sensörü





ARDILA

Aluminium Druckguss, Glas
diecast aluminium, glass
fonte d'aluminium, verre
gegoten aluminium, glas
aluminio fundido, vidrio
pressofusione di alluminio, vetro
fonta aluminiu, sticla
valualumiini, lasi
barwione aluminium, szkło

32 Schwarz matt · black mat

Excl. 1 x E27, max. 40 W

211660132

411660132

511660132



211660132



511660132



411660132

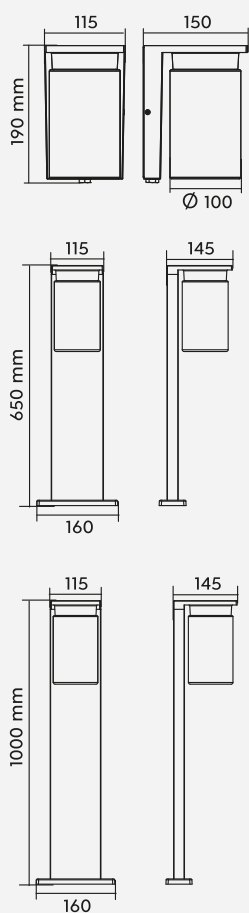

Empfohlen:
recommended:

Filament LED
E27, 4 W
470 lm, 2.700 K



987-400



Dämmerungssensor per Schalter deaktivierbar

On and off switchable dusk sensor

Décteur de crépuscule commutable

Aan en uit schakelbare schemeringsensor

Sensor de oscuridad conmutable on/off

Sensore crepuscolare commutabile on/off

senzor de lumina/amurg on/off

On/off kytkettävä hämärätunnistin

Czujnik zmierzchowy dezaktywowany przez przełącznika

Aç-kapa anahtarlı karanlık sensörü





GARONNE

Aluminium Druckguss, Glas
 diecast aluminium, glass
 fonte d'aluminium, verre
 gegoten aluminium, glas
 aluminio fundido, vidrio
 pressofusione di alluminio, vetro
 fonta aluminiu, sticla
 valualumiini, lasi
 barwione aluminium, szkło

42 Anthrazit · anthracite

Excl. 1 x E27, max. 40 W

201860142

401860142

501860142

Excl. 2 x E27, max. 40 W

201860242

601860242



601860242



201860142



201860242



401860142



501860142

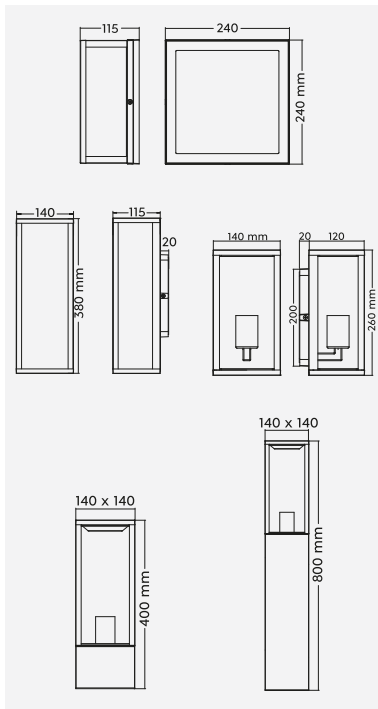

Empfohlen:
 recommended:

Filament LED
 E27, 7 W
 806 lm, 3.000 K



987-600

Empfohlen:
 recommended:

Filament LED
 E27, 4 W
 470 lm, 2.700 K



987-400



GARONNE



401869142

Aluminium Druckguss, Glas
diecast aluminium, glass
fonte d'aluminium, verre
gegoten aluminium, glas
aluminio fundido, vidrio
pressofusione di alluminio, vetro
fonta aluminiu, sticla
valualumiini, lasi
barwione aluminium, szkło

42 Anthrazit · anthracite

Excl. 1 x E27, max. 40 W



IP44

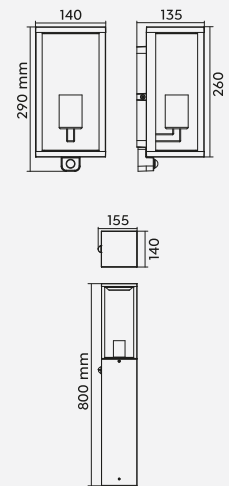

201869142



Bewegungssensor
Motion sensor
Décteur de mouvement
Bewegingssensor
Sensor de movimiento
Sensore di movimento
Senzor de mişcare
Liiketunnistin
Czujnik ruchu

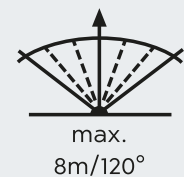

COOPER

Edelstahl, Kunststoff
steel, plastic
acier, plastique
staal, kunststof
acero, plástico
acciaio, plastica
inox, plastic
teräs, muovi
stal, plastik

42 Anthrazit · anthracite

Excl. 1 x E27, max. 40 W



IP44



207360142



407360142



507360142

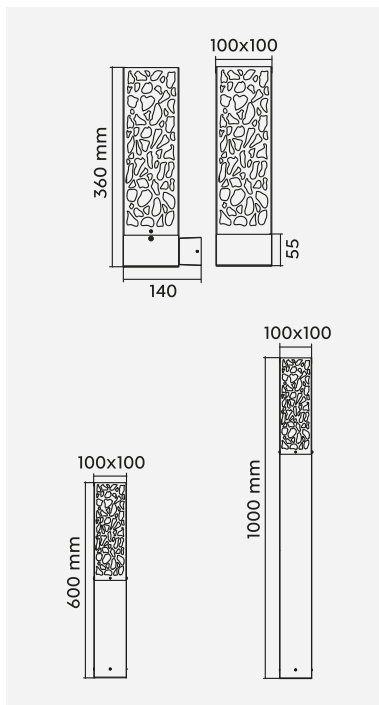

Empfohlen:
recommended:

Filament LED
E27, 4 W
470 lm, 2.700 K





HOOSIC

Aluminium Druckguss, Kunststoff
 diecast aluminium, plastic
 fonte d'aluminium, plastique
 gegoten aluminium, kunststof
 aluminio fundido, plástico
 pressofusione di alluminio, plastica
 fonta aluminiu, plastic
 valualumiini, muov
 barwione aluminium, plastik

32 Schwarz matt · black mat

Excl. 1 x E27, max. 28 W

222260132

422260132

522260132

Excl. 2 x E27, max. 28 W

222260232



222260132



222260232



522260132



422260132

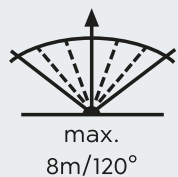
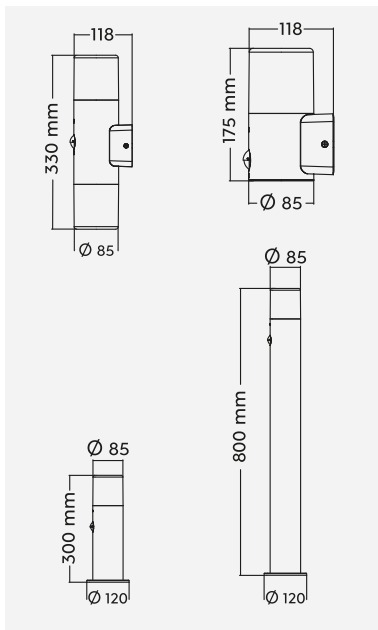

Bewegungssensor
 Motion sensor
 Détecteur de mouvement
 Bewegungssensor
 Sensor de movimiento
 Sensore di movimento
 Senzor de mişcare
 Liiketunnistin
 Czujnik ruchu





HOOSIC

Aluminium Druckguss, Kunststoff
 diecast aluminium, plastic
 fonte d'aluminium, plastique
 gegoten aluminium, kunststof
 aluminio fundido, plástico
 pressofusione di alluminio, plastica
 fonta aluminiu, plastic
 valualumiini, muov
 barwione aluminium, plastik

32 Schwarz matt · black mat

Excl. 1 x E27, max. 28 W

224060132

424060132

524060132

Excl. 2 x E27, max. 28 W

224060232



IP44



224060232



224060132



424060132



524060132

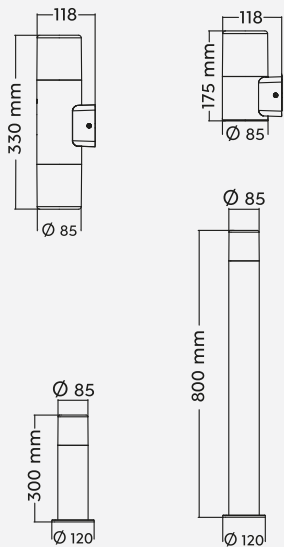

Empfohlen:
 recommended:

LED E27, 4 W
 470 lm, 2.700 K



987-400





HOOSIC

Aluminium Druckguss, Kunststoff
 diecast aluminium, plastic
 fonte d'aluminium, plastique
 gegoten aluminium, kunststof
 aluminio fundido, plástico
 pressofusione di alluminio, plastica
 fonta aluminiu, plastic
 valualumiini, muovi
 barwione aluminium, plastik

42 Anthrazit · anthracite

Excl. 1 x E27, max. 28 W

222260142

422260142

522260142

Excl. 2 x E27, max. 28 W

222260242



222260142



222260242



522260142



422260142

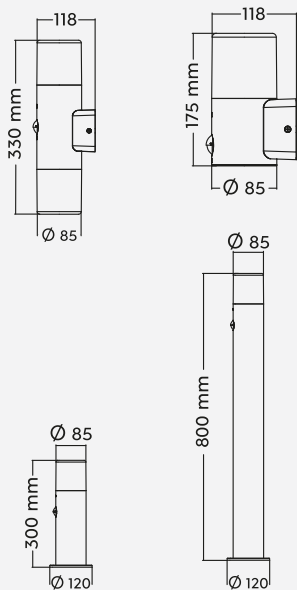

Empfohlen:
 recommended:

LED E27, 4,9 W
 470 lm, 3.000 K



987-60



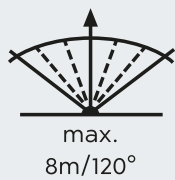

Bewegungssensor
Motion sensor
Détecteur de mouvement
Bewegungssensor
Sensor de movimiento
Sensore di movimento
Senzor de mișcare
Liiketunnistin
Czujnik ruchu



HOOSIC

Aluminium Druckguss, Kunststoff
 diecast aluminium, plastic
 fonte d'aluminium, plastique
 gegoten aluminium, kunststof
 aluminio fundido, plástico
 pressofusione di alluminio, plastica
 fonta aluminiu, plastic
 valualumiini, muovi
 barwione aluminium, plastik

42 Anthrazit · anthracite

Excl. 1 x E27, max. 28 W

224060142

424060142

524060142

Excl. 2 x E27, max. 28 W

224060242



IP44



224060142



224060242



424060142



524060142

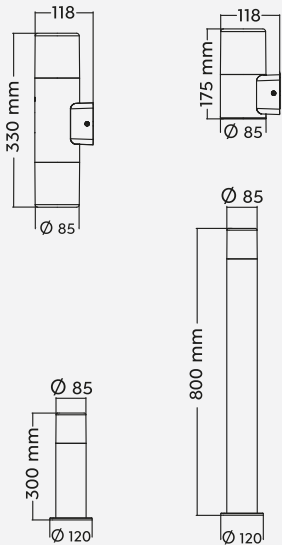

Empfohlen:
 recommended:

LED E27, 4,9 W
 470 lm, 3.000 K



987-60



HOOSIC

Aluminium Druckguss, Kunststoff
diecast aluminium, plastic
fonte d'aluminium, plastique
gegoten aluminium, kunststof
aluminio fundido, plástico
pressofusione di alluminio, plastica
fonta aluminiu, plastic
valualumiini, muovi
barwione aluminium, plastik

42 Anthrazit · anthracite

Excl. 1 x E27, max. 28 W



IP44



424067142



x 2



HOOSIC

Aluminium Druckguss, Kunststoff
 diecast aluminium, plastic
 fonte d'aluminium, plastique
 gegoten aluminium, kunststof
 aluminio fundido, plástico
 pressofusione di alluminio, plastica
 fonta aluminiu, plastic
 valualumiini, muovi
 barwione aluminium, plastik

24 rostfarbig · rusty

Excl. 1 x E27, max. 28 W

222260124

422260124

522260124

Excl. 2 x E27, max. 28 W

222260224



IP44



222260124



222260224



522260124



422260124

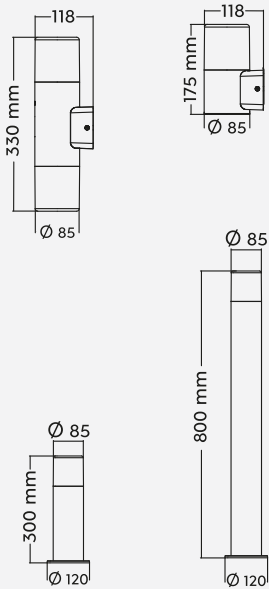

Empfohlen:
 recommended:

LED E27, 4,9 W
 470 lm, 3.000 K



987-60

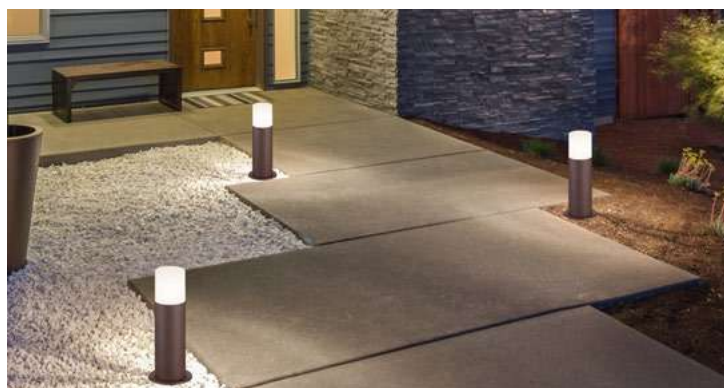



HUDSON

Aluminium Druckguss, Kunststoff
 diecast aluminium, plastic
 fonte d'aluminium, plastique
 gegoten aluminium, kunststof
 aluminio fundido, plástico
 pressofusione di alluminio, plastica
 fonta aluminiu, plastic
 valualumiini, muov
 barwione aluminium, plastik

42 Anthrazit · anthracite

Incl. 1 x LED E14, 4 W
 320 lm, 3.000 K

220060142

420060142

520060142

Incl. 2 x LED E14, 4 W
 2 x 320 lm, 3.000 K

220060242

IP44



220060142



220060242



520060142



420060142

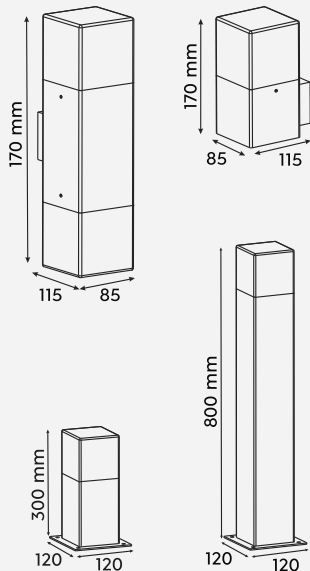

Incl. LED E14, 3,5 W
 320 lm, 3.000 K



983-40

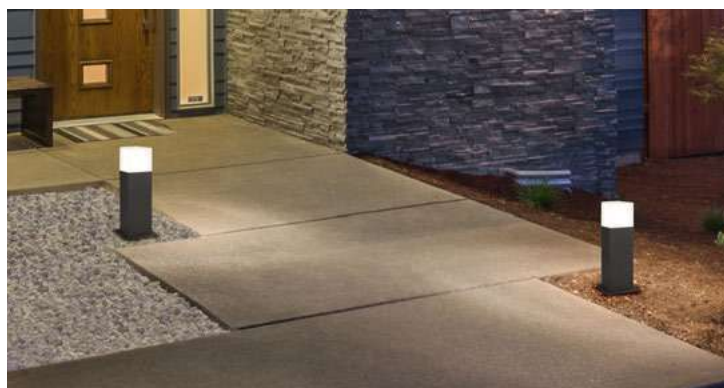



CUBANGO

Aluminium Druckguss, Kunststoff
diecast aluminium, plastic
fonte d'aluminium, plastique
gegoten aluminium, kunststof
aluminio fundido, plástico
pressofusione di alluminio, plastica
fonta aluminiu, plastic
valualumiini, muov
barwione aluminium, plastik

42 Anthrazit · anthracite

Incl. 1 x LED E27, 4,9 W
470 lm, 3.000 K

221560142

Incl. 2 x LED E27, 4,9 W
470 lm, 3.000 K

421560242

IP54

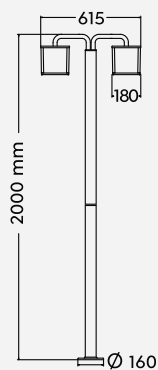
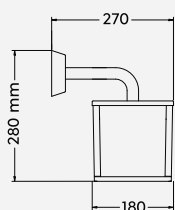

221560142



421560242

Incl. LED E27, 4,9 W
470 lm, 3.000 K





CAVADO

Aluminium Druckguss, Kunststoff
 diecast aluminium, plastic
 fonte d'aluminium, plastique
 gegoten aluminium, kunststof
 aluminio fundido, plástico
 pressofusione di alluminio, plastica
 fonta aluminiu, plastic
 valualumiini, muovi
 barwione aluminium, plastik

42 Anthrazit · anthracite

Excl. 1 x E27, max. 40 W

211069142



Excl. 1 x E27, max. 40 W

211060142

411060142

Excl. 3 x E27, max. 40 W

411060342

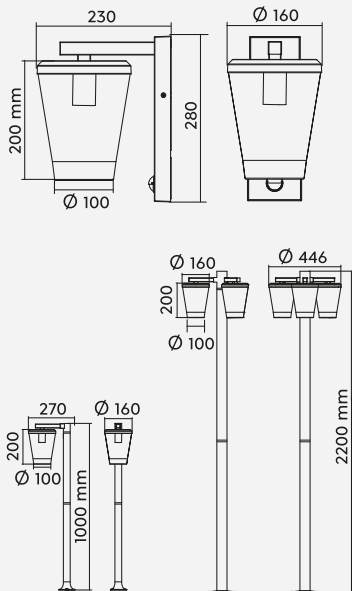

211069142



211060142



411060142



411060342

Empfohlen:
 recommended:

Filament LED
 E27, 4 W
 470 lm, 2.700 K

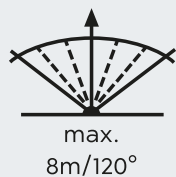



SAMBESI

Aluminium Druckguss, Acryl
diecast aluminium, acryl
fonte d'aluminium, acryl
gegoten aluminium, acryl
aluminio fundido, acrílico
pressofusione di alluminio, acrilico
fonta aluminiu, acrilic
valualumiini, akryyli
barwione aluminium, akryl

31 Weiß matt · white mat

42 Anthrazit · anthracite

Excl. 1 x E27, max. 28 W

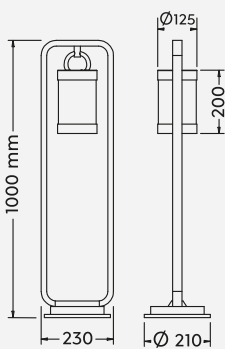
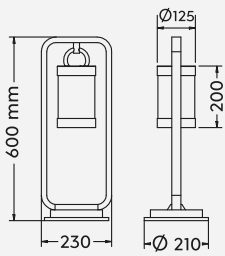
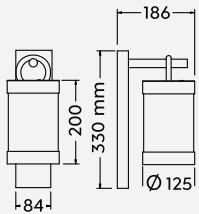

204160131

204160142



504160142

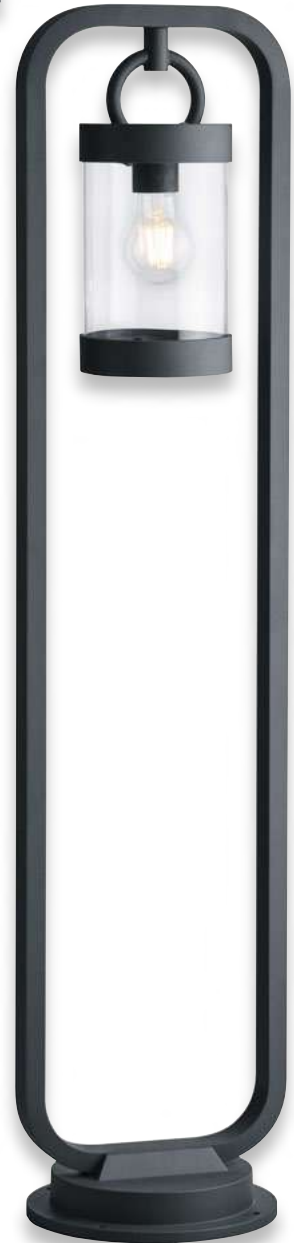

404160142

Empfohlen:
recommended:

Filament LED
E27, 4 W
470 lm, 2.700 K



987-400



Dämmerungssensor per Schalter deaktivierbar

On and off switchable dusk sensor

Détecteur de crépuscule commutable

Aan en uit schakelbare schemeringsensor

Sensor de oscuridad conmutable on/off

Sensore crepuscolare commutabile on/off

senzor de lumina/amurg on/off

On/off kytkettävä hämärätunnistin

Czujnik zmierzchowy dezaktywowany przez przełącznika

Aç-kapa anahtarlı karanlık sensörü



SAMBESI

Aluminium Druckguss, Acryl
diecast aluminium, acryl
fonte d'aluminium, acryl
gegoten aluminium, acryl
aluminio fundido, acrílico
pressofusione di alluminio, acrilico
fonta aluminiu, acrilic
valualumiini, akryyli
barwione aluminium, akryl

24 rostfarbig · rusty

Excl. 1 x E27, max. 28 W



204160124

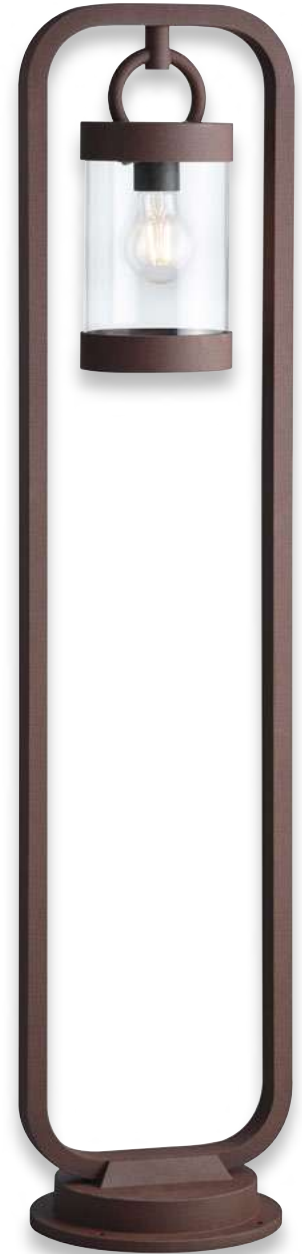

404160124

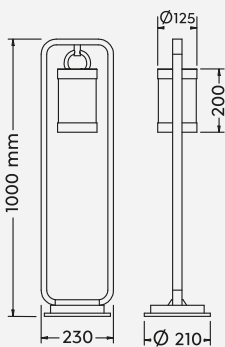
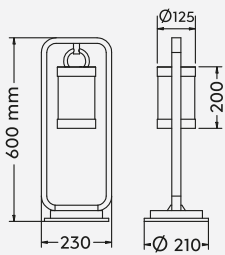
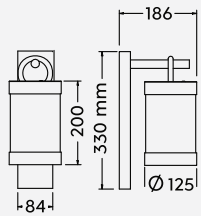

504160124

Empfohlen:
recommended:

Filament LED
E27, 4 W
470 lm, 2.700 K



987-400



Dämmerungssensor per Schalter deaktivierbar

On and off switchable dusk sensor

Décteur de crépuscule commutable

Aan en uit schakelbare schemeringsensor

Sensor de oscuridad conmutable on/off

Sensore crepuscolare commutabile on/off

senzor de lumina/amurg on/off

On/off kytkettävä hämärätunnistin

Czujnik zmierzchowy dezaktywowany przez przełącznika

Aç-kapa anahtarlı karanlık sensörü

SAMBESI

Aluminium Druckguss, Kunststoff
diecast aluminium, plastic
fonte d'aluminium, plastique
gegoten aluminium, kunststof
aluminio fundido, plástico
pressofusione di alluminio, plastica
fonta aluminiu, plastic
valualumiini, muovi
barwione aluminium, plastik

24 rostfarbig · rusty

31 Weiß matt · white mat

42 Anthrazit · anthracite

Excl. 1 x E27, max. 28 W

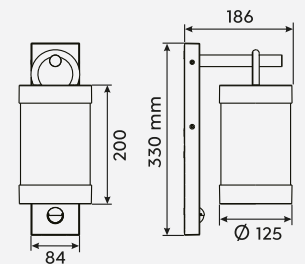

204169142



204169131



Bewegungssensor
Motion sensor
Détecteur de mouvement
Bewegungssensor
Sensor de movimiento
Sensore di movimento
Senzor de mişcare
Liiketunnistin
Czujnik ruchu

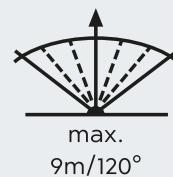

204169124

LUNGA

Aluminium Druckguss, Glas
diecast aluminium, glass
fonte d'aluminium, verre
gegoten aluminium, glas
aluminio fundido, vidrio
pressofusione di alluminio, vetro
fonta aluminiu, sticla
valualumiini, lasi
barwione aluminium, szkło

42 Anthrazit · anthracite

Excl. 1 x E27, max. 40 W

212060142



Excl. 1 x E27, max. 40 W

212069142



212060142



212069142

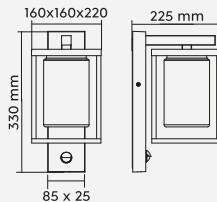
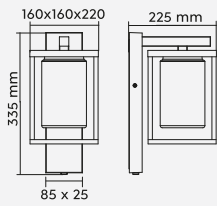

Empfohlen:
recommended:

Filament LED
E27, 4 W
470 lm, 2.700 K



987-400



Dämmerungssensor per Schalter deaktivierbar

On and off switchable dusk sensor

Détecteur de crépuscule commutable

Aan en uit schakelbare schemeringsensor

Sensor de oscuridad conmutable on/off

Sensore crepuscolare commutabile on/off

senzor de lumina/amurg on/off

On/off kytkettävä hämärätunnistin

Czujnik zmierzchowy dezaktywowany przez przełącznika

Aç-kapa anahtarlı karanlık sensörü





Bewegungssensor
Motion sensor
Détecteur de mouvement
Bewegingssensor
Sensor de movimiento
Sensore di movimento
Senzor de mișcare
Liiketunnistin
Czujnik ruchu

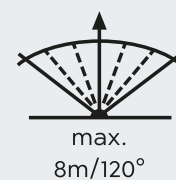

NORMAN

Aluminium Druckguss, Acryl
diecast aluminium, acryl
fonte d'aluminium, acryl
gegoten aluminium, acryl
aluminio fundido, acrílico
pressofusione di alluminio, acrilico
fonta aluminiu, acrilic
valualumiini, akryyli
barwione aluminium, akryl

24 rostfarbig · rusty

42 Anthrazit · anthracite

Excl. 1 x E27, max. 40 W

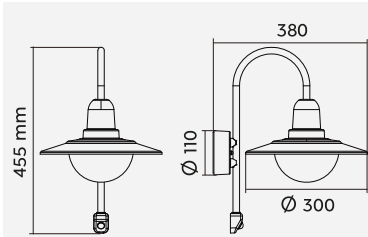

207269142



207269124

Empfohlen:
recommended:

LED E27, 4,9 W
470 lm, 3.000 K

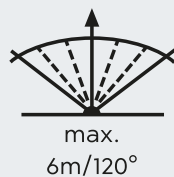

Bewegungssensor
Motion sensor
Détecteur de mouvement
Bewegingssensor
Sensor de movimiento
Sensore di movimento
Senzor de mişcare
Liiketunnistin
Czujnik ruchu

BRENTA

Aluminium Druckguss, Glas
diecast aluminium, glass
fonte d'aluminium, verre
gegooten aluminium, glas
aluminio fundido, vidrio
pressofusione di alluminio, vetro
fonta aluminiu, sticla
valualumiini, lasi
barwione aluminium, szkło

24 rostfarbig · rusty

42 Anthrazit · anthracite

Excl. 1 x E27, max. 40 W



IP44

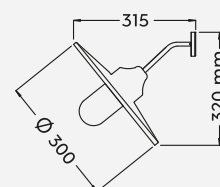

201760124



201760142



Empfohlen:
recommended:

Filament LED
E27, 4 W
470 lm, 2.700 K



987-400

OLONA

Aluminium Druckguss, Glas
diecast aluminium, glass
fonte d'aluminium, verre
gegoten aluminium, glas
aluminio fundido, vidrio
pressofusione di alluminio, vetro
fonta aluminiu, sticla
valualumiini, lasi
barwione aluminium, szkło

24 rostfarbig · rusty

42 Anthrazit · anthracite

Excl. 1 x E27, max. 40 W



IP23

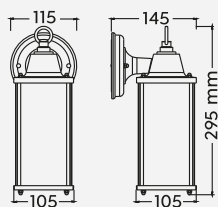

201960142

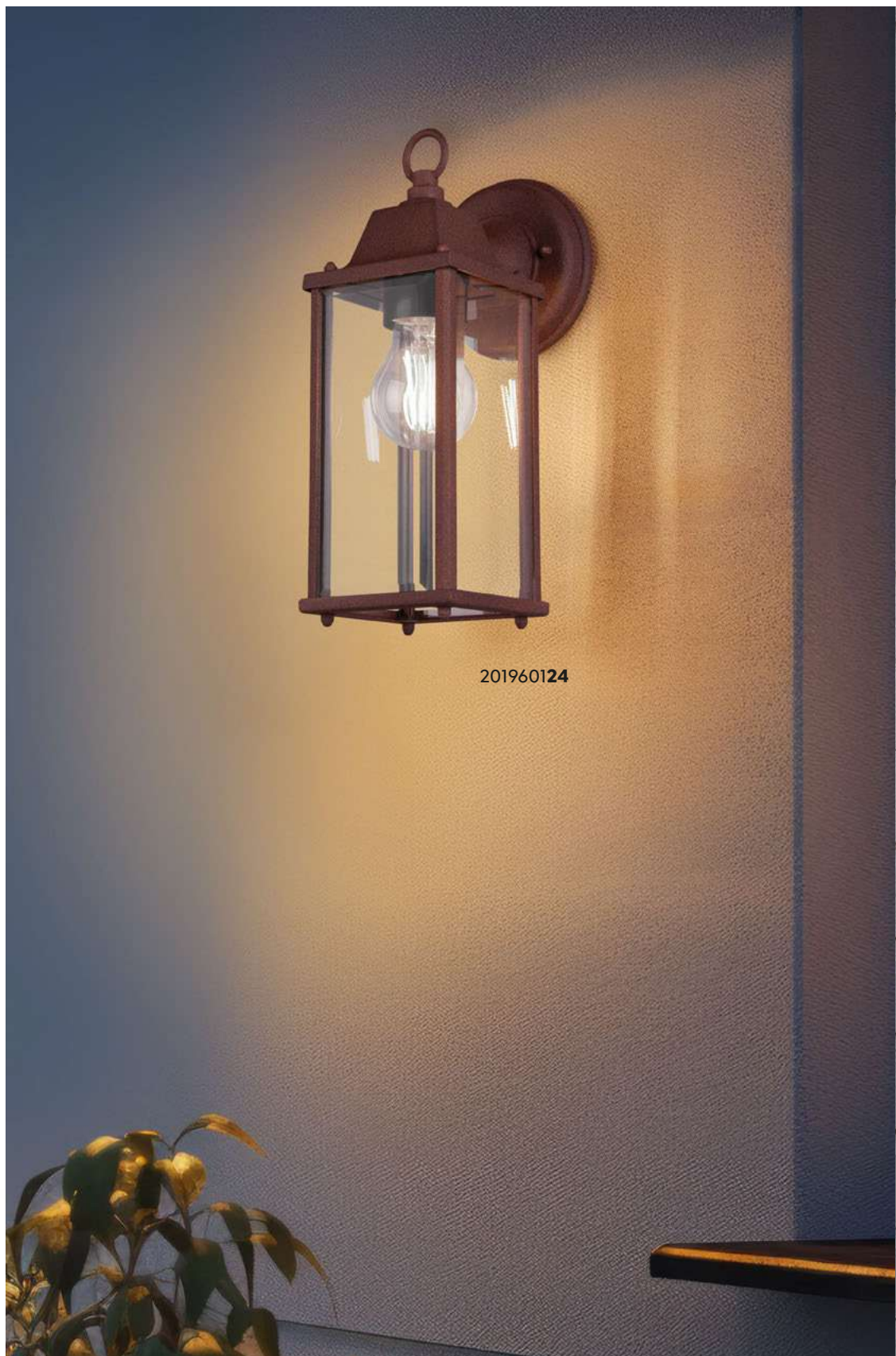

201960124

Empfohlen:
recommended:

Filament LED
E27, 4 W
470 lm, 2.700 K



987-400



TANARO

Aluminium Druckguss, Acryl
diecast aluminium, acryl
fonte d'aluminium, acryl
gegoten aluminium, acryl
aluminio fundido, acrílico
pressofusione di alluminio, acrilico
fonta aluminiu, acrilic
valualumiini, akryyli
barwione aluminium, akryl

24 rostfarbig · rusty

42 Anthrazit · anthracite

Excl. 1 x E27, max. 40 W



IP44

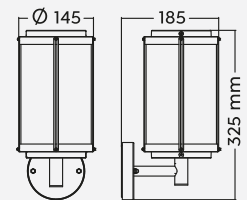

202360142



202360124



Empfohlen:
recommended:

Filament LED
E27, 4 W
470 lm, 2.700 K



987-400

DUERO

Aluminium Druckguss, Glas
diecast aluminium, glass
fonte d'aluminium, verre
gegoten aluminium, glas
aluminio fundido, vidrio
pressofusione di alluminio, vetro
fonta aluminiu, sticla
valualumiini, lasi
barwione aluminium, szkło

24 rostfarbig · rusty

42 Anthrazit · anthracite

Excl. 1 x E27, max. 40 W



IP44

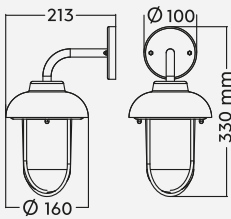

202760124



202760142

Empfohlen:
recommended:

Filament LED
E27, 4 W
470 lm, 2.700 K



987-400



TUELA

Aluminium Druckguss, Glas
diecast aluminium, glass
fonte d'aluminium, verre
gegoten aluminium, glas
aluminio fundido, vidrio
pressofusione di alluminio, vetro
fonta aluminiu, sticla
valualumiini, lasi
barwione aluminium, szkło

42 Anthrazit · anthracite

Excl. 1 x E27, max. 40 W

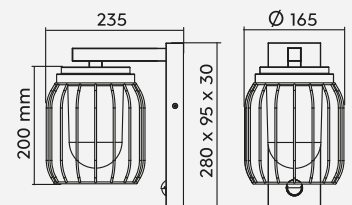

210869142



210860142



Bewegungssensor
Motion sensor
Détecteur de mouvement
Bewegungssensor
Sensor de movimiento
Sensore di movimento
Senzor de mişcare
Liiketunnistin
Czujnik ruchu

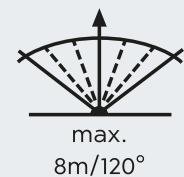
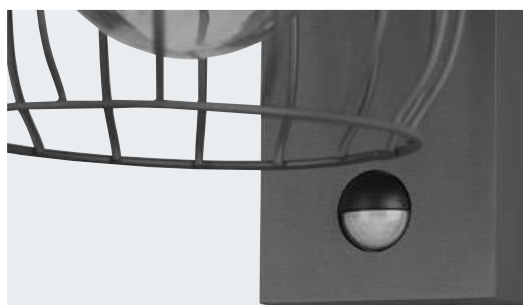

max.
8m/120°

VOLTURNO

Aluminium Druckguss, Glas
 diecast aluminium, glass
 fonte d'aluminium, verre
 gegoten aluminium, glas
 aluminio fundido, vidrio
 pressofusione di alluminio, vetro
 fonta aluminiu, sticla
 valualumiini, lasi
 barwione aluminium, szkło

28 rostfarbig antik · antique rust

Excl. 1 x E27, max. 40 W

205960128

205967128

405960128

505960128

Excl. 3 x E27, max. 60 W

405960328



IP44



205967128



205960128



405960328

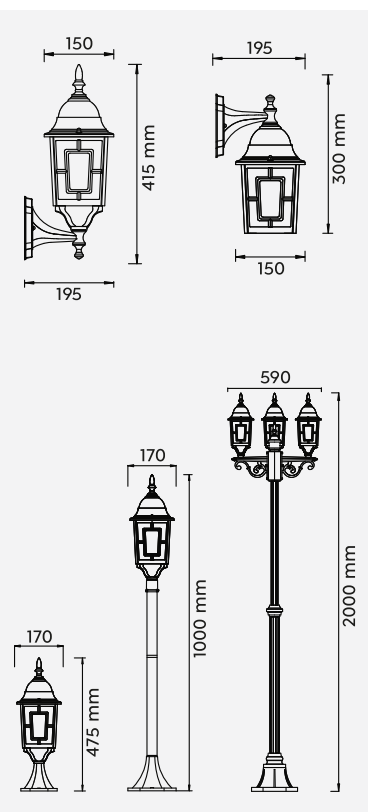

405960128



505960128

Empfohlen:
 recommended:

Filament LED
 E27, 4 W
 470 lm, 2.700 K



987-400





LIVENZA

Aluminium Druckguss, Glas
 diecast aluminium, glass
 fonte d'aluminium, verre
 gegoten aluminium, glas
 aluminio fundido, vidrio
 pressofusione di alluminio, vetro
 fonta aluminu, sticla
 valualumiini, lasi
 barwione aluminium, szkło

32 Schwarz matt · black mat

Excl. 1 x E27, max. 40 W

205760132

205767132

405760132

505760132

Excl. 3 x E27, max. 40 W

405760332

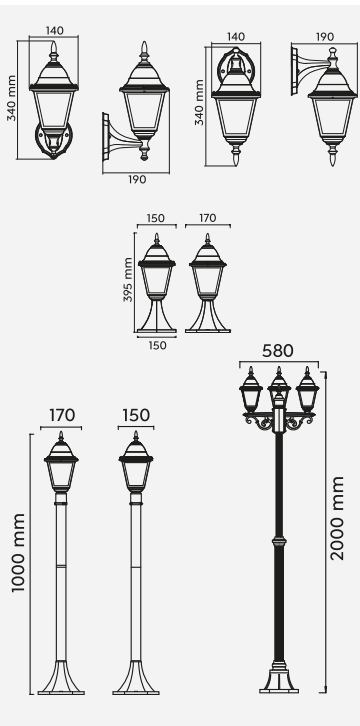

205767132



205760132



405760132



505760132



405760332

Empfohlen:
 recommended:

Filament LED
 E27, 4 W
 470 lm, 2.700 K



987-400





ELVO

Aluminium Druckguss, Glas
 diecast aluminium, glass
 fonte d'aluminium, verre
 gegoten aluminium, glas
 aluminio fundido, vidrio
 pressofusione di alluminio, vetro
 fonta aluminiu, sticla
 valualumiini, lasi
 barwione aluminium, szkło

32 Schwarz matt · black mat

Excl. 1 x E27, max. 40 W

206960132

206967132

406960132

506960132

Excl. 3 x E27, max. 40 W

406960332



IP44

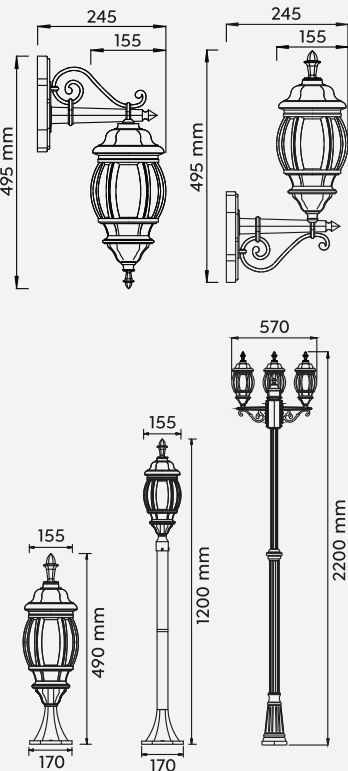

206960132



206967132



406960332



406960132



506960132

Empfohlen:
 recommended:

Filament LED
 E27, 4 W
 470 lm, 2.700 K



987-400





UBANGI

Aluminium Druckguss
diecast aluminium
fonte d'aluminium
gegoten aluminium
aluminio fundido
pressofusione di alluminio
fonta aluminii
valualumiini
barwione aluminium

42 Anthrazit · anthracite

Excl. 1 x GU10, max. 28 W

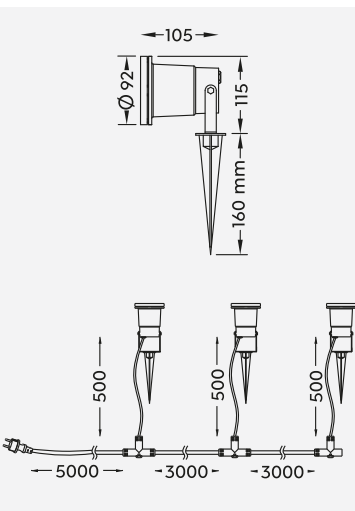

Empfohlen:
recommended:

LED GU10, 5 W
400 lm, 3.000 K
≥ 110°



955-50



MAREB

Aluminium Druckguss
diecast aluminium
fonte d'aluminium
gegoten aluminium
aluminio fundido
pressofusione di alluminio
fonta aluminiu
valualumiini
barwione aluminium

42 Anthrazit · anthracite

Incl. 1 x SMD-LED, 11 W
1.000 lm, 3.000 K

IP65

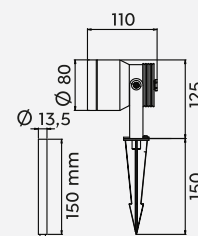

821860142



BELAJA

Bodeneinbaustrahler
Recessed floor lamps
Luminaire encastrés de sol
grond inbouwspot
Lámparas de pie empotradas
Incasso Calpestabili
Lampi incastrate in podea
upotetut maavalot
wpuszczane lampy podłogowe

07 Nickel matt · nickel mat

Incl. SMD-LED, 3,5 W
350 lm, 3.000 K

821660107

Incl. SMD-LED, 8 W
900 lm, 3.000 K

821660207

IP65

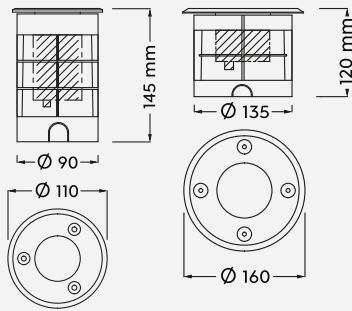

821660107



821660207



Abstrahlwinkel
Emission angle
Angle de rayonnement
Uitstraalhoek
Ángulo de emisión
Angolo di emissione
Unghiul de emisii
Säteilykulma
Kät emisiji



Belastbarkeit
Resilience
Limite de charge
Belastbaarheid
Resistencia
Resistenza
Rezistența la solicitare
Kuormitettavuus
Nośność



GARTENSTECKDOSEN · GARDEN SOCKETS



9964-42

Aluminium Druckguss
diecast aluminium
fonte d'aluminium
gegoten aluminium
aluminio fundido
pressofusione di alluminio
fonta aluminiu
valualumiini
barwione aluminium

42 Anthrazit · anthracite

max. 3.600 W

IP44  x 4

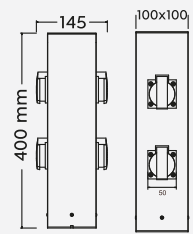

9962-11

Polyresin
polyresin
polyresin
polyresin
poliresina
poliestere
polirasina
polyresiini
polyresin

11 Grau · grey

max. 3.600 W

9962-11

IP44   x 4

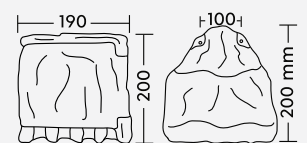

 x 4



UNIVERSAL-ERDSPIESS · GROUND SPIKE

Erdspieß, Edelstahl
Ground spike, steel
Piquet de terre, acier
Aardingspin, staal
Espiga, acero
Picchetto, acciaio
Țepușă pentru pământ, inox
Maapiikki, teräs
Žerdz, stal

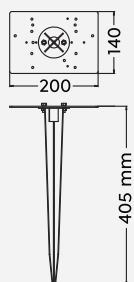

9960-07

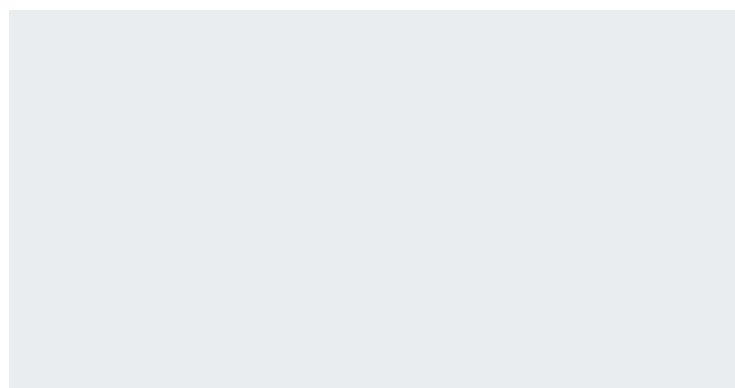

ECKBEFESTIGUNG · CORNER FASTENING

Eckbefestigung, Kunststoff
Corner fastening, plastic
Montage en angle, plastique
Hoekbevestiging, kunststof
Cantонера, plástico
Montaggio ad angolo, plastica
Fixare pentru colț, plastic
Kulmakiinnike, muovi
Okucie narożne, plastik

32 Schwarz matt · black mat

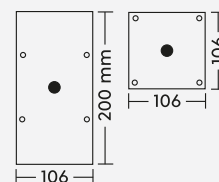

9965-32

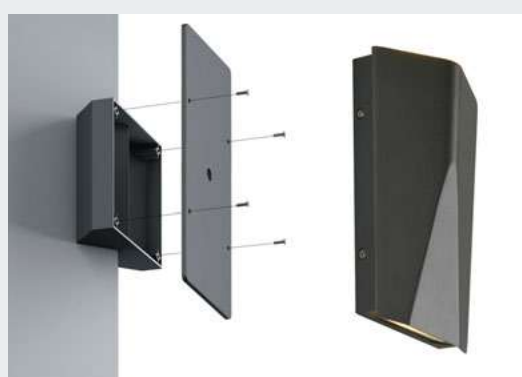





PALOMA

Metall, Kunststoff
 metal, plastic
 metale, plastique
 metaal, kunststof
 metal, plástico
 metallo, plastica
 metal, plastic
 metalli, muovi
 metal, plastik

42 Anthrazit · anthracite

Excl. 1 x E27, max. 28 W



R21719142



R41719142



R51719142

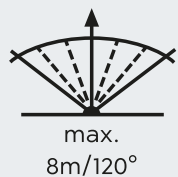
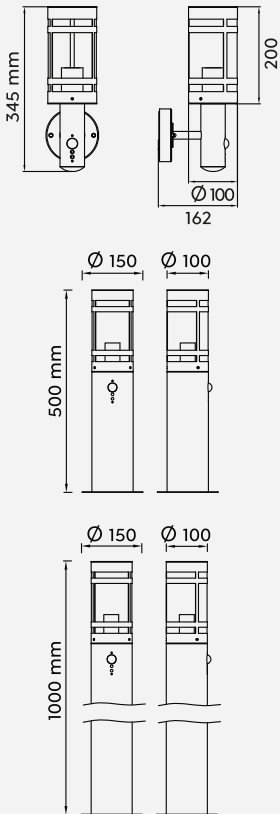

Bewegungssensor
 Motion sensor
 Détecteur de mouvement
 Bewegungssensor
 Sensor de movimiento
 Sensore di movimento
 Senzor de mişcare
 Liiketunnistin
 Czujnik ruchu





PALOMA

Metall, Kunststoff
metal, plastic
metale, plastique
metaal, kunststof
metal, plástico
metallo, plastica
metal, plastic
metalli, muovi
metal, plastik

42 Anthrazit · anthracite

Excl. 1 x E27, max. 28 W



IP44

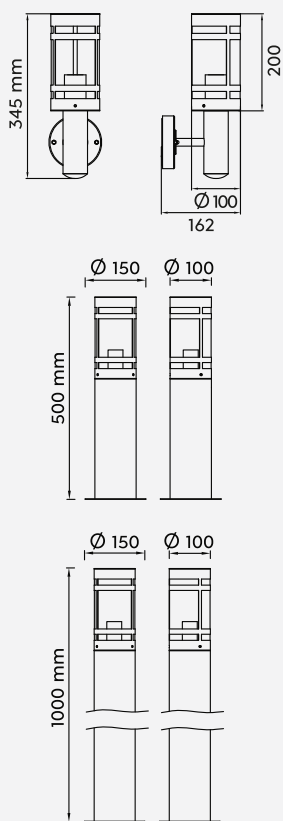

R21716142



R51716142



R41716142

Empfohlen:
recommended:

Filament LED
E27, 4 W
470 lm, 2.700 K





BONITO

Aluminium Druckguss, Kunststoff
 diecast aluminium, plastic
 fonte d'aluminium, plastique
 gegoten aluminium, kunststof
 aluminio fundido, plástico
 pressofusione di alluminio, plastica
 fonta aluminiu, plastic
 valualumiini, muov
 barwione aluminium, plastik

- 24** rostfarbig · rusty
- 31** Weiß matt · white mat
- 32** Schwarz matt · black mat

Excl. 1 x E27, max. 28 W

- R21596124**
- R21596131**
- R21596132**



Excl. 1 x E27, max. 28 W

- R21599124**
- R21599131**
- R21599132**

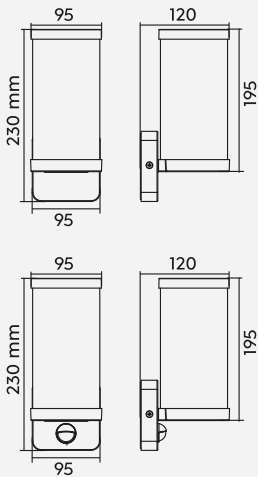

R21596124



R21596131



R21596132



R21599131



R21599132



R21599124

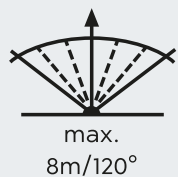

Bewegungssensor
 Motion sensor
 Détecteur de mouvement
 Bewegungssensor
 Sensor de movimiento
 Sensore di movimento
 Senzor de mişcare
 Liiketunnistin
 Czujnik ruchu





CORDOBA

Kunststoff
plastic
plastique
kunststof
plástico
plastica
plastic
muovi
plastik

31 Weiß matt · white mat

32 Schwarz matt · black mat

Incl. 2 x SMD-LED, 2 W
2 x 200 lm, 3.000 K



R28222631



R28222632

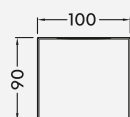
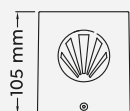

ROSARIO

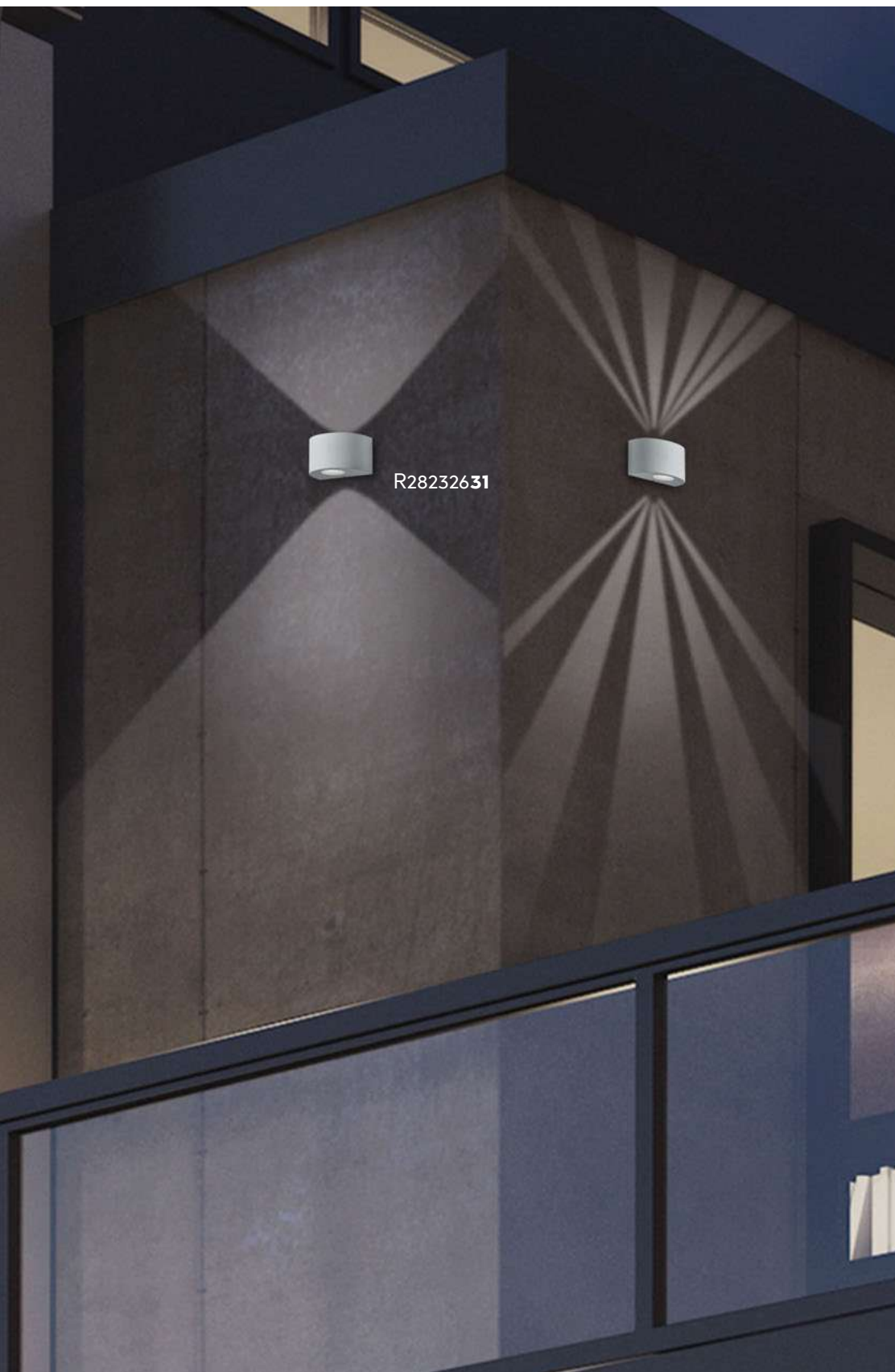

R28232631

Kunststoff
plastic
plastique
kunststof
plástico
plastica
plastic
muovi
plastik

31 Weiß matt · white mat

32 Schwarz matt · black mat

Incl. 2 x SMD-LED, 2 W
2 x 200 lm, 3.000 K

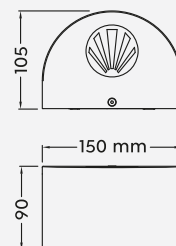

R28232632



MOLINA

Aluminium Druckguss, Kunststoff
diecast aluminium, plastic
fonte d'aluminium, plastique
gegoten aluminium, kunststof
aluminio fundido, plástico
pressofusione di alluminio, plastica
fonta aluminiu, plastic
valualumiini, muovi
barwione aluminium, plastik

42 Anthrazit · anthracite

Incl. 2 x SMD-LED, 4,6 W
2 x 550 lm, 3.000 K

IP54

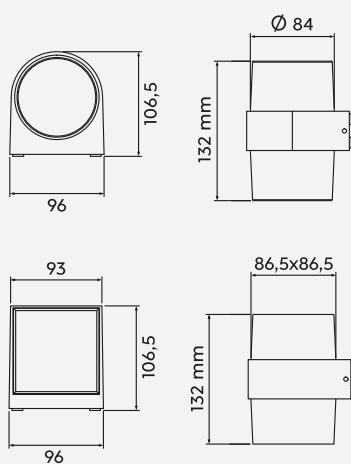

R22052142



R22062142



LIMEIRA

Kunststoff
plastic
plastique
kunststof
plástico
plastica
plastic
muovi
plastik

32 Schwarz matt · black mat

Incl. 2 x SMD-LED, 3,5 W
2 x 380 lm, 3.000 K

IP44

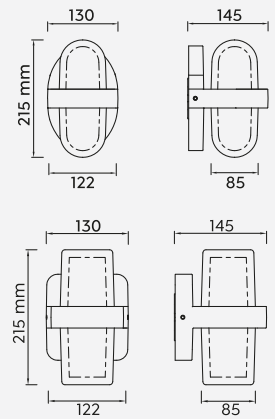

R24256232



R24266232



PUNO

Kunststoff
plastic
plastique
kunststof
plástico
plastica
plastic
muovi
plastik

32 Schwarz matt · black mat

Incl. SMD-LED, 8 W
800 lm, 3.000 K

IP54

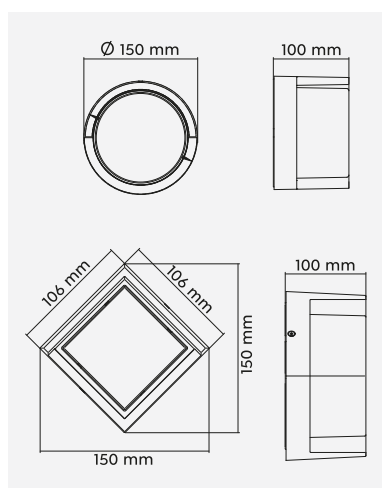

R27036132



R27026132





PUELO

Aluminium Druckguss, Kunststoff
diecast aluminium, plastic
fonte d'aluminium, plastique
gegoten aluminium, kunststof
aluminio fundido, plástico
pressofusione di alluminio, plastica
fonta aluminiu, plastic
valualumiini, muovi
barwione aluminium, plastik

31 Weiß matt · white mat

32 Schwarz matt · black mat

Excl. 1 x E27, max. 10 W



IP44

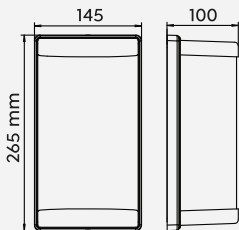

R21186132



R21186131



Empfohlen:
recommended:

LED E27, 4,9 W
470 lm, 3.000 K



987-60



CALERA

Aluminium Druckguss, Kunststoff
diecast aluminium, plastic
fonte d'aluminium, plastique
gegoten aluminium, kunststof
aluminio fundido, plástico
pressofusione di alluminio, plastica
fonta aluminiu, plastic
valualumiini, muovi
barwione aluminium, plastik

32 Schwarz matt · black mat

Incl. 1 x SMD-LED, 8 W
800 lm, 3.000 K

IP54

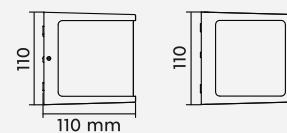

R27446132



VENADO

Kunststoff
plastic
plastique
kunststof
plástico
plastica
plastic
muovi
plastik

42 Anthrazit · anthracite

Incl. 1 x SMD-LED, 9,5 W
1.000 lm, 3.000 K

IP54

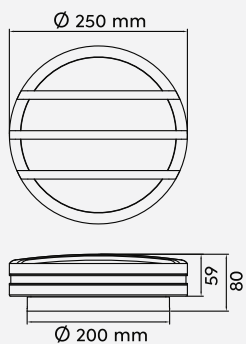

R24236142

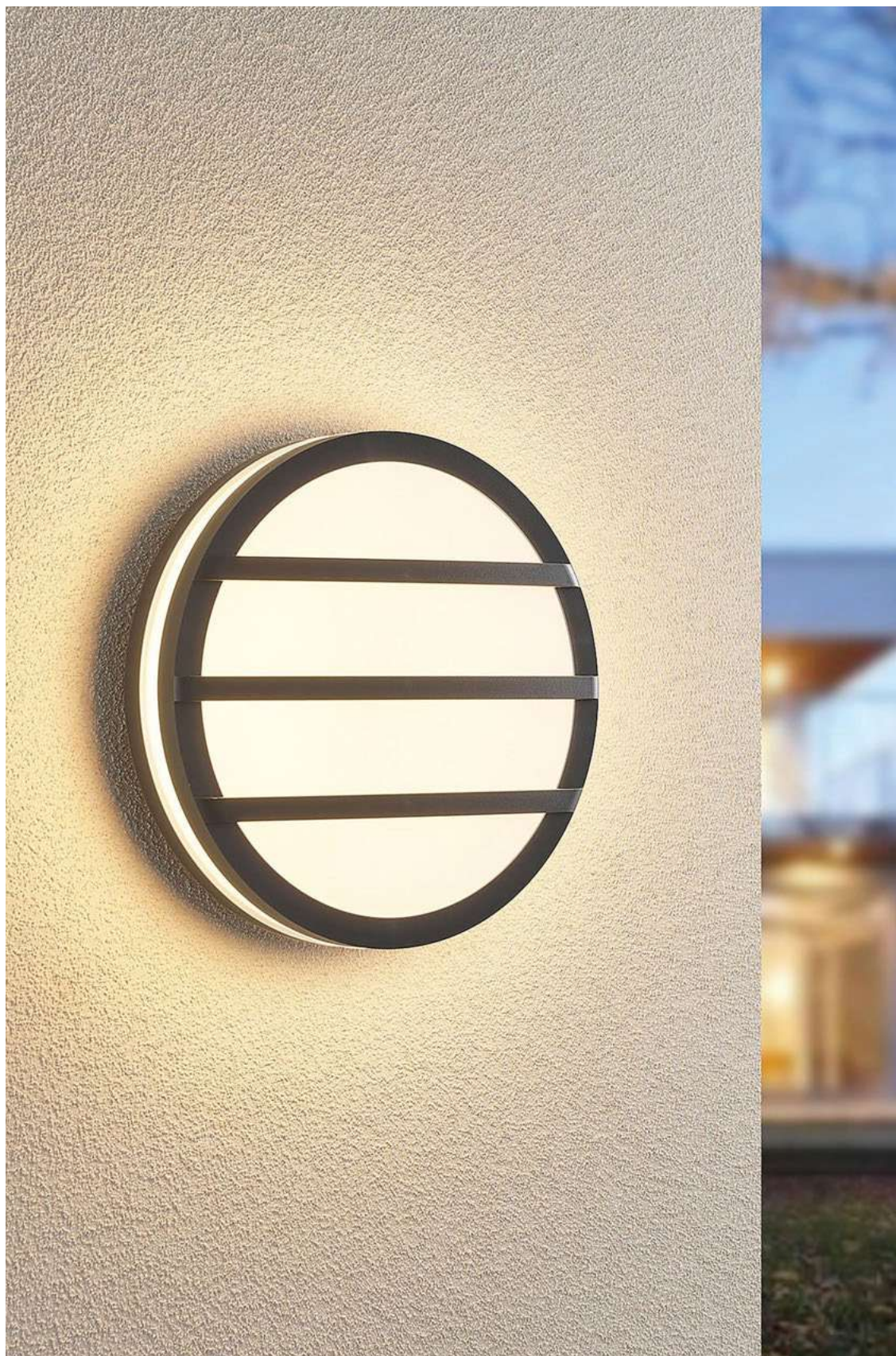

MORENA

Kunststoff
plastic
plastique
kunststof
plástico
plastica
plastic
muovi
plastik

32 Schwarz matt · black mat

Incl. 1 x SMD-LED, 14 W
1.500 lm, 2.300 + 3.000 + 4.000 K

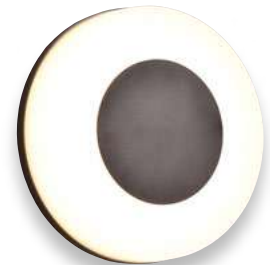
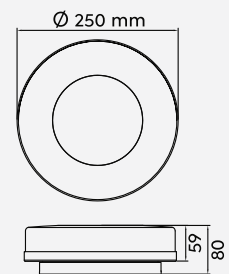

R242461**32**



DIP SWITCH

Lichtfarben direkt an der Leuchte einstellbar

Colours directly adjustable at the lamp

Les couleurs de la lumière peuvent être réglées directement sur le luminaire

Lichtkleuren direct instelbaar op de lamp

Tonalidades de luz ajustables directamente en la lámpara

Colori della luce regolabili direttamente sulla lampada

Colori ale luminii reglabile direct de la bec

Valon väri asetettävissa suoraan valaisimesta

Barwy światła można ustawić bezpośrednio na oprawie

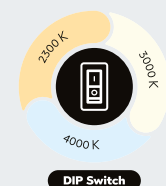

CAMARO

Kunststoff
 plastic
 plastique
 kunststof
 plástico
 plastica
 plastic
 muovi
 plastik

31 Weiß matt · white mat

42 Anthrazit · anthracite

Excl. 1 x E27, max. 12 W

R60501031

R60501042

Excl. 2 x E27, max. 12 W

R60502031

R60502042



IP54

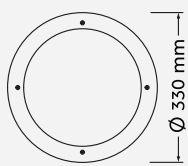
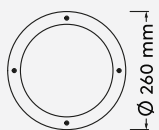

R60501031



R60501042



R60502031



R60502042

Empfohlen:
 recommended:

LED E27, 4 W
 320 lm, 3.000 K



986-60



KENDAL

Kunststoff
plastic
plastique
kunststof
plástico
plastica
plastic
muovi
plastik

42 Anthrazit · anthracite

Incl. SMD-LED, 11 W
1.180 lm, 3.000 K

R62151142

Incl. SMD-LED, 12 W
1.400 lm, 3.000 K

R22151142

IP54

R22151142

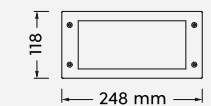
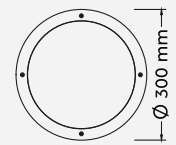

R62151142





Außenbeleuchtung ist viel mehr als nur funktional!

Dank integriertem Akku sind die transportablen Leuchten flexibel und setzen spannende Akzente im Garten, auf dem Balkon oder der Terrasse - ganz ohne Kabel! Für die richtige Stimmung sorgen zusätzliche Highlights wie RGB-Farbwechsler oder Bluetooth-Funktion für kabelloses Musik hören. Die perfekte Beleuchtung für gemeinsame Abendstunden mit Familie und Freunden.

Outdoor lighting is much more than just functional!

Integrated rechargeable batteries lets you flexibly use these easily transportable lights to accent your garden, balcony or terrace in an exciting way, all without any cables! Additional highlights like an RGB colour wheels and Bluetooth for streaming music wirelessly provide just the right mood. The perfect lighting for spending evening hours with family and friends.

L'éclairage extérieur est bien plus que simplement fonctionnel !

Grâce à la batterie rechargeable intégrée, les lampes transportables sont flexibles et mettent des accents excitants dans le jardin, sur le balcon ou la terrasse –

sans aucun câble ! D'autres fonctions marquantes garantissent une bonne ambiance, telles que le changeur de couleurs RVB ou la fonction Bluetooth pour l'écoute de musique sans fil. L'éclairage parfait pour les soirées partagées avec la famille et les amis.

Buitenverlichting is veel meer dan enkel nuttig!

Dankzij de geïntegreerde accu zijn de verplaatsbare lampen flexibel en zorgen voor mooie accenten in de tuin, op het balkon of op het terras, en dat helemaal zonder kabel! Voor de juiste stemming zorgen extra hoogtepunten zoals de RGB-kleurenwisselaar of Bluetooth-functie om draadloos muziek te beluisteren. De perfecte verlichting om 's avonds aangenaam te vertoeven met vrienden en familie.

¡La iluminación exterior es mucho más que algo funcional!

Gracias a la batería integrada, las luces transportables son flexibles y aportan puntos de atención excitantes al jardín, al balcón o a la terraza - ¡y sin ningún tipo de cables! Se consigue el ambiente adecuado con otras características especiales adicionales como el modificador de color RGB o la función Bluetooth para escuchar música sin cables. La iluminación perfecta para pasar la tarde con la familia y los amigos.



L'illuminazione esterna è molto più che funzionale!

Grazie alla batteria ricaricabile integrata, le lampade portatili sono flessibili e creano accenti emozionanti in giardino, sul balcone o sulla terrazza - senza cavi! Ulteriori punti di forza come il cambiacolori RGB o la funzione Bluetooth per l'ascolto di musica senza fili assicurano il giusto feeling. L'illuminazione perfetta per le ore serali da trascorrere insieme alla famiglia e agli amici.

Iluminarea exterioară este mult mai mult decât funcțională!

Datorită acumulatorului integrat, lămpile transportabile sunt flexibile și oferă un aspect atrăgător în grădină, pe balcon sau pe terasă - fără cablu! Atmosfera potrivită este asigurată de jocurile suplimentare de lumină cum ar fi schimbarea culorilor RGB sau funcția Bluetooth pentru a asculta muzică fără cablu. Iluminarea perfectă pentru orele de seară cu familia și prietenii.

Ulkovalaistus on paljon muutakin kuin vain toimintaa!

Integroidun ladattavan akun ansiosta siirrettävät valaisimet ovat joustavia ja muodostavat jännittäviä korostuksia puutarhaan, parvekkeelle tai terassille - ilman kaapeleita! Lisäkorostukset, kuten RGB-värvivaihtajat tai Bluetooth-toiminto langattomaan musiikin kuuntelun, takaavat oikean ilmapiirin. Täydellinen valaistus illanviettoon yhdessä perheen ja ystävien kanssa.

Oświetlenie zewnętrzne to znacznie więcej niż tylko funkcjonalność!

Dzięki akumulatorowi przenośne lampy są elastyczne w ustawieniu i tworzą ekscytujące akcenty w ogrodzie, na balkonie lub tarasie - bez żadnych kabli! Odpowiedni nastrój zapewnią dodatkowe urządzenia, takie jak zmieniające kolorów RGB lub funkcja Bluetooth do bezprzewodowego słuchania muzyki. Doskonałe oświetlenie wspólnych wieczorów z rodziną i przyjaciółmi.

SUAREZ

Metall
metal
metale
metaal
metal
metallo
metal
metalli
metal

10 Rot · red
31 Weiß matt · white mat
32 Schwarz matt · black mat
49 Pistaziengrün · pistachio green

Incl. 1 x SMD-LED, 2 W
200 lm, 3.000 K

R47706110
R47706131
R47706132
R47706149



Incl. 1 x SMD-LED, 1,5 W
200 lm, 3.000 K

R57706110
R57706131
R57706132
R57706149

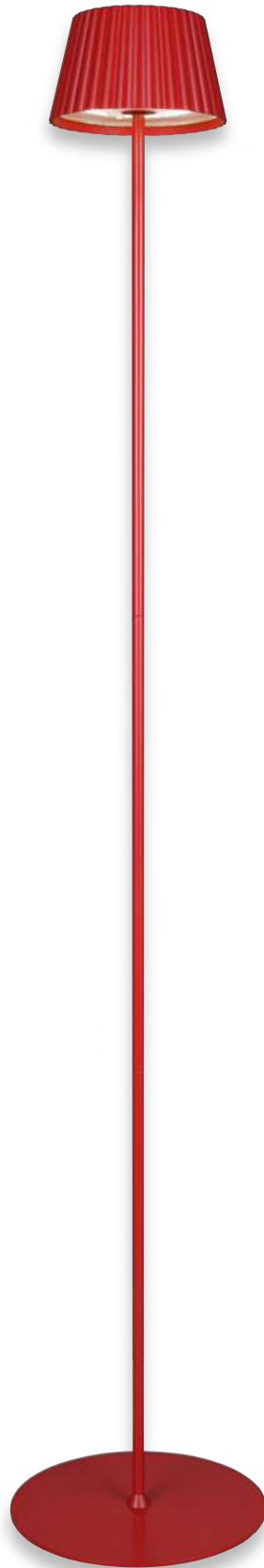
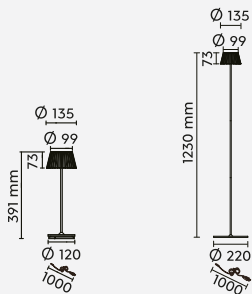

R47706110

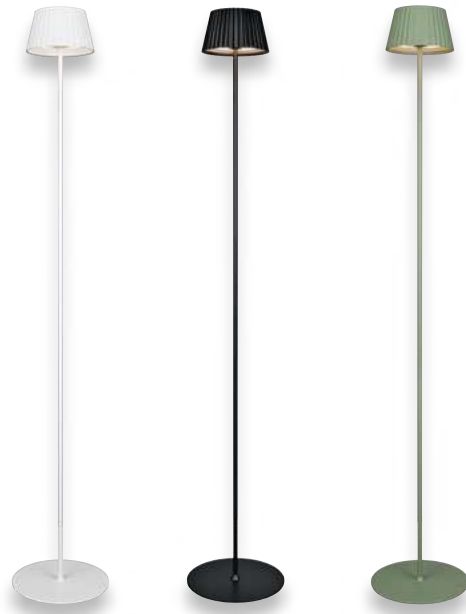

R47706131

R47706132

R47706149

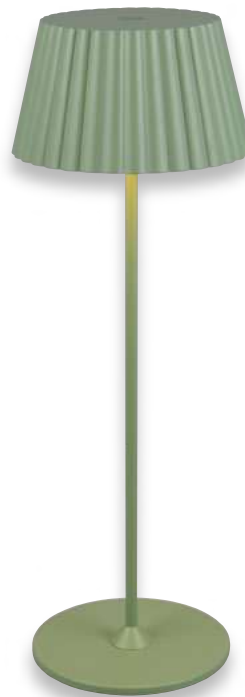

R57706149



R57706132

R57706131

R57706110



Inklusive Ladestation
Charging station included
Station de recharge incluse
Laadstation inbegrepen
Estación de carga incluida
Stazione di ricarica inclusa
Stație de încărcare inclusă
Latausasema sisältyy
W zestawie stacja ładowująca



USB-C Anschluss mit Ladefunktion
Recharging USB-C connection
Entrée USB-C de rechargement
Opladende USB-C aansluiting
Conexión USB-C de recarga
Connessione USB-C di ricarica
Conexiune USB-C reîncărcare
Lataaminen USB-C-liitäntä
ładowania USB-C połączenie



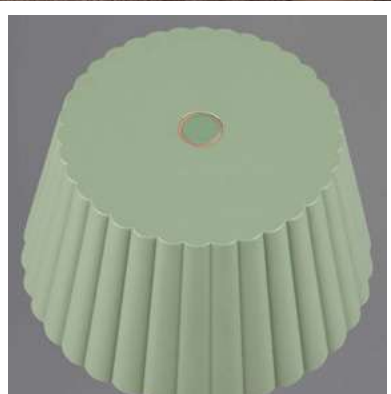

FUNGO

Aluminium Druckguss, Kunststoff
 diecast aluminium, plastic
 fonte d'aluminium, plastique
 gegoten aluminium, kunststof
 aluminio fundido, plástico
 pressofusione di alluminio, plastica
 fonta aluminiu, plastic
 valualumiini, muovi
 barwione aluminium, plastik

- 10** Rot · red
- 31** Weiß matt · white mat
- 42** Anthrazit · anthracite
- 49** Pistaziengrün · pistachio green
- 66** Sand · sable

Incl. 1 x SMD-LED, 2 W
 200 lm, 3.000 + 4.000 + 6.500 K

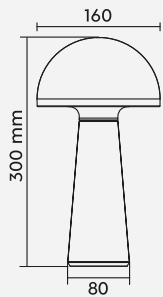

R57716110



R57716131



R57716142



R57716149



R57716166



Inklusive Ladestation
 Charging station included
 Station de recharge incluse
 Laadstation inbegrepen
 Estación de carga incluida
 Stazione di ricarica inclusa
 Stație de încărcare inclusă
 Latausasema sisältyy
 W zestawie stacja ładowująca





RICARDO

Kunststoff
 plastic
 plastique
 kunststof
 plástico
 plastica
 plastic
 muovi
 plastik

- 10** Rot · red
- 31** Weiß matt · white mat
- 32** Schwarz matt · black mat
- 49** Pistaziengrün · pistachio green
- 66** Sand · sable
- 77** Ultimate Grau · ultimate grey

Incl. 1 x SMD-LED, 1,7 W
 240 lm, 3.000 K

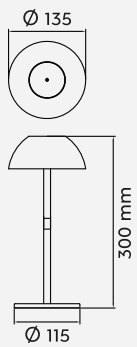

R54106110

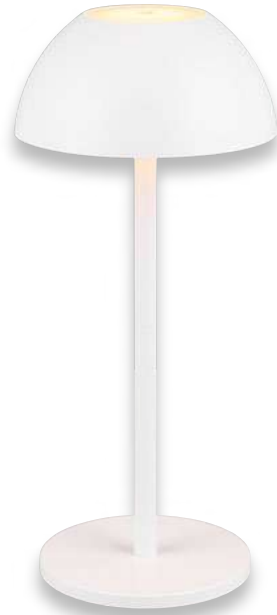

R54106131



R54106132



R54106149

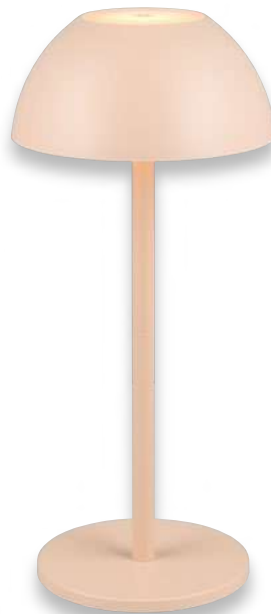

R54106166



R54106177



USB-C Anschluss mit Ladefunktion
 Recharging USB-C connection
 Entrée USB-C de rechargement
 Opladende USB-C aansluiting
 Conexión USB-C de recarga
 Connessione USB-C di ricarica
 Conexiune USB-C reîncărcare
 Lataaminen USB-C-liitäntä
 ładowania USB-C połączenie



FERNANDEZ

Metall, Kunststoff
 metal, plastic
 metale, plastique
 metaal, kunststof
 metal, plástico
 metallo, plastica
 metal, plastic
 metalli, muovi
 metal, plastik

31 Weiß matt · white mat
32 Schwarz matt · black mat
77 Ultimate Grau · ultimate grey

Incl. 1 x SMD-LED, 1,5 W
 130 lm, 2.700 + 4.000 + 6.000 K

R54096131
 R54096132
 R54096177

Incl. 6 x SMD-LED, 6 x 1,5 W
 6 x 130 lm, 2.700 + 4.000 + 6.000 K

R54096631
 R54096632
 R54096677



R54096131



R54096132



R54096177

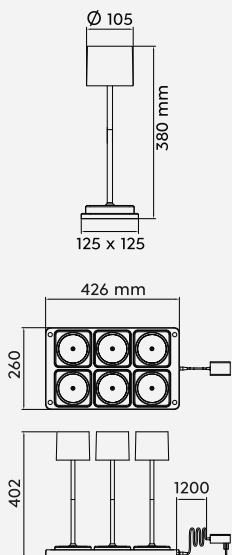

6er Set / Set 6



R54096631



R54096632



R54096677



Inklusive Ladestation
 Charging station included
 Station de recharge incluse
 Laadstation inbegrepen
 Estación de carga incluida
 Stazione di ricarica inclusa
 Stație de încărcare inclusă
 Latausasema sisältyy
 W zestawie stacja ładowająca



Lichtfarbe einstellbar
 Adjustable light color
 Couleur de lumière réglable
 Lichtkleur instelbaar
 Color de luz regulable
 Colore della luce regolabile
 Lumina colorata reglabila
 Värilämpötila säädettävissä
 Regulowana barwa światła



ELLIOT

Kunststoff
 plastic
 plastique
 kunststof
 plástico
 plastica
 plastic
 muovi
 plastik

31 Weiß matt · white mat
32 Schwarz matt · black mat
49 Pistaziengrün · pistachio green

Incl. 1 x SMD-LED, 2 W
 180 lm, 3.000 K

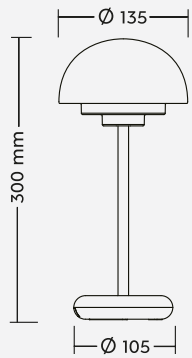

R52306132



R52306149

R52306131



USB-C



USB-C Anschluss mit Ladefunktion
 Recharging USB-C connection
 Entrée USB-C de rechargement
 Opladende USB-C aansluiting
 Conexión USB-C de recarga
 Connessione USB-C di ricarica
 Conexiune USB-C reîncărcare
 Lataaminen USB-C-liitäntä
 ładowania USB-C połączenie

LENNON

Kunststoff
plastic
plastique
kunststof
plástico
plastica
plastic
muovi
plastik

- 01** Weiß · white
- 02** Schwarz · black
- 49** Pistaziengrün · pistachio green
- 77** Ultimate Grau · ultimate grey
- 83** Illuminate Gelb · illuminate yellow

Incl. 1 x SMD-LED, 2 W
180 lm, 3.000 K

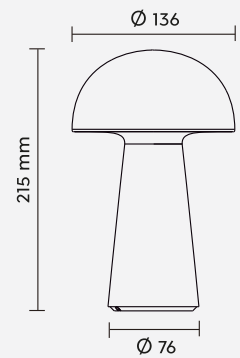

USB-C



R52176102



R52176101



R52176177



MARTINEZ

Metall, Kunststoff
 metal, plastic
 metale, plastique
 metaal, kunststof
 metal, plástico
 metallo, plastica
 metal, plastic
 metalli, muovi
 metal, plastik

31 Weiß matt · white mat

32 Schwarz matt · black mat

Incl. 1 x SMD-LED, 2,2 W
 250 lm, 2.700 - 6.500 K

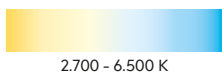
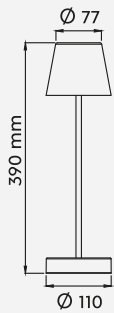

R54086131

R54086132



Lichtfarbe stufenlos einstellbar
 Light color infinitely variable
 Couleur de lumière infiniment variable
 Lichtkleur traploos instelbaar
 Color de luz infinitamente variable
 Colore della luce infinitamente variabile
 Culoare lumină infinit variabilă
 Valon väri portaattomasti
 Jasny kolor bezstopniowo

TORREZ

Kunststoff
 plastic
 plastique
 kunststof
 plástico
 plastica
 plastic
 muovi
 plastik

31 Weiß matt · white mat
32 Schwarz matt · black mat
77 Ultimate Grau · ultimate grey

Incl. 1 x SMD-LED, 2 W
 180 lm, 3.000 + 4.000 + 5.000 K

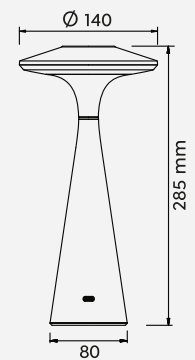

R57726131

R57726132



R57726177



Lichtfarbe einstellbar
 Adjustable light color
 Couleur de lumière réglable
 Lichtkleur instelbaar
 Color de luz regulable
 Colore della luce regolabile
 Lumina colorata reglabila
 Väriämpötila säädettävissä
 Regulowana barwa światła



USB-C Anschluss mit Ladefunktion
 Recharging USB-C connection
 Entrée USB-C de rechargement
 Opladende USB-C aansluiting
 Conexión USB-C de recarga
 Connessione USB-C di ricarica
 Conexiune USB-C reîncărcare
 Lataaminen USB-C-liitäntä
 ładowania USB-C połączenie



SANCHEZ

Kunststoff
 plastic
 plastique
 kunststof
 plástico
 plastica
 plastic
 muovi
 plastik

31 Weiß matt · white mat
42 Anthrazit · anthracite

Incl. 1 x SMD-LED, 2,1 W
 190 lm, 3.000 + 4.000 + 5.000 K

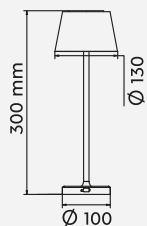
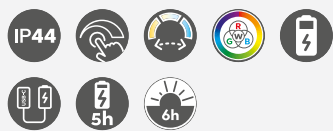

R54126131



R54126142



3.000 K

4.000 K

5.000 K



USB-C Anschluss mit Ladefunktion
 Recharging USB-C connection
 Entrée USB-C de rechargement
 Opladende USB-C aansluiting
 Conexión USB-C de recarga
 Connessione USB-C di ricarica
 Conexiune USB-C reîncărcare
 Lataaminen USB-C-liitäntä
 ładowania USB-C połączenie





DORA

Kunststoff
plastic
plastique
kunststof
plástico
plastica
plastic
muovi
plastik

01 Weiß · white

Incl. 1 x SMD-LED, 1,5 W
90 lm, 3.000 K

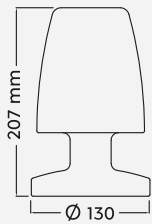

R57051101



Ladezeit
Charging time
Temps de charge
Oplaaadtijd
Tiempo de carga
Tempo di carica
Timp de incarcare
Latausaika
Czas ładowania



Leuchtdauer
Luminous period
Durée d'éclairage
Brandtijd
Tiempo de iluminación
Tempo di durata
Perioada de iluminare
Valaistusaika
Czas świecenia

Kunststoff
 plastic
 plastique
 kunststof
 plástico
 plastica
 plastic
 muovi
 plastik

01 Weiß · white

Incl. 1 x SMD-LED, 1,5 W
 90 lm, 3.000 K

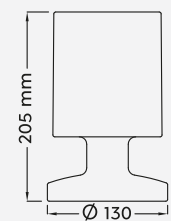

R57071101



Akkubetrieb
 Rechargeable battery operated
 Fonctionnement sur batteries rechargeable
 Oplaadbare accu
 Batería recargable
 Batteria Ricaricabile
 Operabil prin baterie reincarcabila
 Ladattava akku
 Akumulator zasilany baterijnie



USB Anschluss mit Ladefunktion
 Recharging USB connection
 Entrée USB de rechargement
 Opladende USB aansluiting
 Conexión USB de recarga
 Connessione USB di ricarica
 Conexiune USB reîncărcare
 Lataaminen USB-liitäntä
 ładowania USB połączenie

PALMAS

Kunststoff
plastic
plastique
kunststof
plástico
plastica
plastic
muovi
plastik

01 Weiß · white

Incl. 1 x RGBW-LED, 1,5 W
45 lm, 3.000 K

R55101101

Incl. 1 x RGBW-LED, 3 W
90 lm, 3.000 K

R45101101

Incl. 1 x RGBW-LED, 4,5 W
120 lm, 3.000 K

R45101901

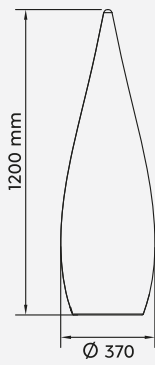
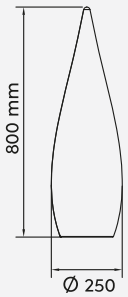

R55101101



R45101101



R45101901



RGBW Farbwechsler
RGBW Colorchanging
Changement de couleur RGBW
RGBW Kleurverandering
Cambio de color RGBW
Cambia colore RGBW
Schimbator de culoare RGBW
Värinvaihto RGB
Zmieniający kolor RGBW



Akkubetrieb
Rechargeable battery operated
Fonctionnement sur batteries rechargeable
Oplaadbare accu
Batería recargable
Batteria Ricaricabile
Operabil prin baterie reincarcabila
Ladattava akku
Akumulator zasilany bateryjnje
Şarj edilebilir pilli



Ladezeit
Charging time
Temps de charge
Oplaaftijd
Tiempo de carga
Tempo di carica
Timp de incarcare
Latausaika
Czas ładowania



Leuchtdauer
Luminous period
Durée d'éclairage
Brandtijd
Tiempo de iluminación
Tempo di durata
Perioada de iluminare
Valaistusaika
Czas świecenia

ARUBA

Kunststoff
plastic
plastique
kunststof
plástico
plastica
plastic
muovi
plastik

01 Weiß · white

Incl. 1 x RGBW-LED, 1 W
70 lm, 3.000 K

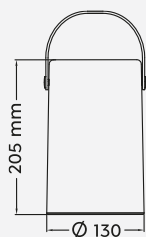

R57080101



USB Anschluss mit Ladefunktion
Recharging USB connection
Entrée USB de rechargement
Opladende USB aansluiting
Conexión USB de recarga
Connessione USB di ricarica
Conexiune USB reîncărcare
Lataaminen USB-liitäntä
ładowania USB połączenie
şarj USB bađlantı



Ladezeit
Charging time
Temps de charge
Oplaadtijd
Tiempo de carga
Tempo di carica
Timp de încarcare
Latausaika
Czas ładowania



Leuchtdauer
Luminous period
Durée d'éclairage
Brandtijd
Tiempo de iluminación
Tempo di durata
Perioada de iluminare
Valaistus aika
Czas świecenia

JAMAICA

Kunststoff
plastic
plastique
kunststof
plástico
plastica
plastic
muovi
plastik

01 Weiß · white

Incl. 1 x RGBW-LED, 2,5 W
25 lm, 3.000 K

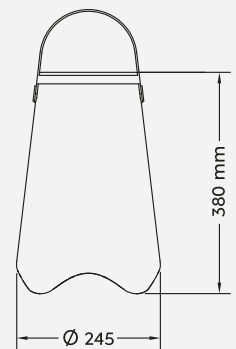
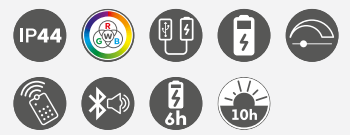

LIGHT & SOUND



R55086101

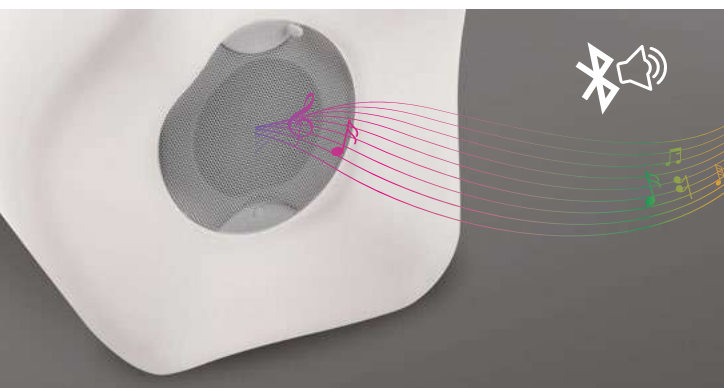

BOLO

Kunststoff
plastic
plastique
kunststof
plástico
plastica
plastic
muovi
plastik

54 rauchfarbig · smoke

Excl. 1 x E27, max. 40 W



R57042054

R57043054



R57044054

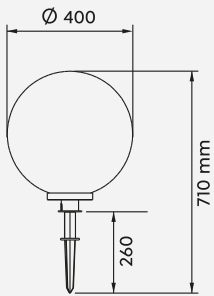
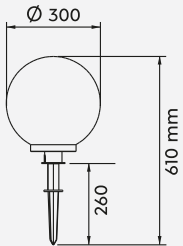
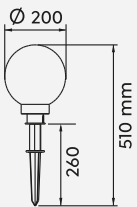

Empfohlen:
recommended:

Filament LED
E27, 4 W
470 lm, 2.700 K





BOLO

Kunststoff
plastic
plastique
kunststof
plástico
plastica
plastic
muovi
plastik

01 Weiß · white

Excl. 1 x E27, max. 23 W

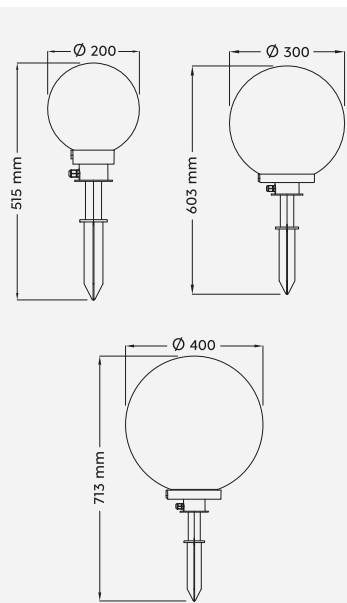

R57043001



R57042001



R57044001

Empfohlen:
recommended:

LED E27, 4,9 W
470 lm, 3.000 K



987-60







Sonne Tanken!

Solarleuchten nutzen ausschließlich die Kraft der Sonne um Licht zu erzeugen. Dabei sind sie extrem umwelt-schonend, sparsam und gleichermaßen praktisch, da sie weder Steckdosen noch einen Anschluss ans Stromnetz benötigen. In Kombination mit moderner LED-Technik bieten Solarleuchten ideales Licht für Haus und Garten.

Soak up the sun!

Solar lamps exclusively use the power of the sun to generate light. At the same time they are extremely environmentally friendly and economical as well as practical, as they need neither sockets nor a connection to the mains supply. In combination with modern LED technology, solar lamps provide an ideal light for home and garden.

Faites le plein de soleil !

Les lampes solaires utilisent exclusivement l'énergie du soleil pour générer de la lumière. En même temps, elles sont extrêmement écologiques, économiques et tout aussi pratiques, car elles ne nécessitent ni prise de courant ni raccordement au réseau électrique. En combinaison avec la technologie LED moderne, les lampes solaires fournissent une lumière idéale pour la maison et le jardin.

Doe zon op!

Zonnelampen maken uitsluitend gebruik van de kracht van de zon om licht te produceren. Daarbij zijn ze extreem milieuvriendelijk, zuinig en in gelijke mate praktisch, omdat ze noch een stopcontact noch een aansluiting op het stroomnet nodig hebben. In combinatie met moderne ledtechniek bieden z onnelampen ideaal licht voor huis en tuin.

¡Disfrute del sol!

Las luces solares usan exclusivamente la energía del sol para generar luz. Al mismo tiempo, son extremadamente ecológicas, económicas e igualmente prácticas, y no necesitan ni enchufes ni conexión a la corriente. En combinación con las modernas técnicas LED, las luces solares ofrecen una luz ideal para la casa y el jardín.



Prendete un po' di sole!

Le lampade solari utilizzano esclusivamente la potenza del sole per generare luce. Allo stesso tempo sono estremamente rispettose dell'ambiente, economiche e pratiche in quanto non richiedono né presa di corrente, né un collegamento alla rete elettrica. In combinazione con la moderna tecnologia LED, le lampade solari forniscono una luce ideale per la casa e il giardino.

Alimentați cu soare!

Lămpile solare se folosesc în exclusivitate de energia soarelui pentru a genera lumină. În acest context sunt extrem de ecologice, economice și practice în același timp, deoarece nu necesită nici prize și nici conectarea la o rețea electrică. În combinație cu tehnologia modernă LED, lămpile solare oferă lumina ideală pentru casă și grădină.

Ajattele aurinkoa!

Aurinkovalaisimet käyttävät auringon energiaa valon tuottamiseen. Samalla ne ovat erittäin ympäristöystävällisiä, taloudellisia ja myös käytännöllisiä, koska ne eivät vaadi pistorasioita tai liitäntää sähköverkkoon. Yhdessä modernin LED-tekniikan kanssa aurinkovalaisimet tarjoavat ihanteellisen valaistuksen kotiin ja puutarhaan.

Nałapać energii słonecznej!

Lampy solarne wykorzystują moc słońca do generowania światła. Są one przy tym niezwykle przyjazne dla środowiska, ekonomiczne i jednocześnie praktyczne, ponieważ nie wymagają gniazd ani podłączenia do sieci elektrycznej. W połączeniu z nowoczesną technologią LED lampy solarne zapewniają idealne oświetlenie domu i ogrodu.

Kunststoff
 plastic
 plastique
 kunststof
 plástico
 plastica
 plastic
 muovi
 plastik

42 Anthrazit · anthracite

Incl. 1 x SMD-LED, 4,5 W
 290 lm, 3.000 K



R22251142



R42251142

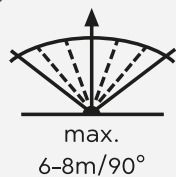
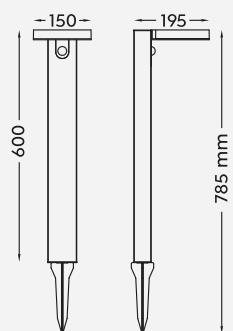
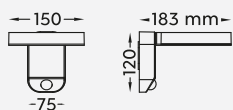

Ladezeit
 Charging time
 Temps de charge
 Oplaadtijd
 Tiempo de carga
 Tempo di carica
 Timp de incarcare
 Latausaika
 Czas ładowania



Leuchtdauer
 Luminous period
 Durée d'éclairage
 Brandtijd
 Tiempo de iluminación
 Tempo di durata
 Perioada de iluminare
 Valaistusaika
 Czas świecenia





Kunststoff
 plastic
 plastique
 kunststof
 plástico
 plastica
 plastic
 muovi
 plastik

42 Anthrazit · anthracite

Incl. 1 x SMD-LED, 4,5 W
 290 lm, 3.000 K

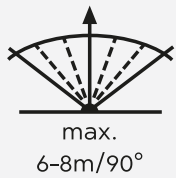
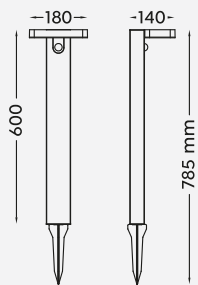
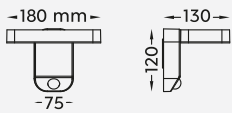

R22261142



R42261142



Ladezeit
 Charging time
 Temps de charge
 Oplaadtijd
 Tiempo de carga
 Tempo di carica
 Timp de incarcare
 Latausaika
 Czas ładowania



Leuchtdauer
 Luminous period
 Durée d'éclairage
 Brandtijd
 Tiempo de iluminación
 Tempo di durata
 Perioada de iluminare
 Valaistusaika
 Czas świecenia



Kunststoff
 plastic
 plastique
 kunststof
 plástico
 plastica
 plastic
 muovi
 plastik

42 Anthrazit · anthracite

Incl. 1 x SMD-LED, 5 W
 200 lm, 3.000 K

R22241142



Incl. 1 x SMD-LED, 4,8 W
 340 lm, 3.000 K

R22281142

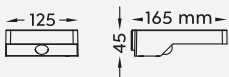

FOMOSA

R22281142



MENDOZA

R22241142



max.
 5-8m/90°



Ladezeit
 Charging time
 Temps de charge
 Oplaadtijd
 Tiempo de carga
 Tempo di carica
 Timp de încarcare
 Latausaika
 Czas ładowania

SALTA

Metall, Acryl
metal, acryl
metale, acryl
metaal, acryl
metal, acrílico
metallo, acrilico
metal, acrilic
metalli, akryyli
metal, akryl

07 Nickel matt · nickel mat

42 Anthrazit · anthracite

Incl. 1 x SMD-LED, 3 W
165 lm, 3.000 K

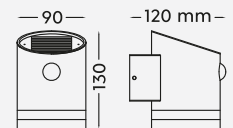

R22231142



Leuchtdauer
Luminous period
Durée d'éclairage
Brandtijd
Tiempo de iluminación
Tempo di durata
Perioada de iluminare
Valaistusaika
Czas świecenia

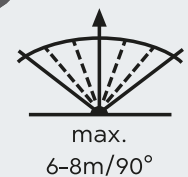

SILVA

Kunststoff
plastic
plastique
kunststof
plástico
plastica
plastic
muovi
plastik

01 Weiß · white

Incl. 1 x SMD-LED, 0,1 W

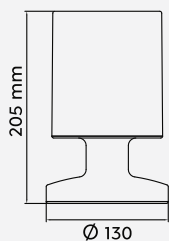

R54076101



Ladezeit
Charging time
Temps de charge
Oplaadtijd
Tiempo de carga
Tempo di carica
Timp de incarcare
Latausaika
Czas ładowania



Leuchtdauer
Luminous period
Durée d'éclairage
Brandtijd
Tiempo de iluminación
Tempo di durata
Perioada de iluminare
Valaistusaika
Czas świecenia



USB-C



R54066101

Kunststoff
 plastic
 plastique
 kunststof
 plástico
 plastica
 plastic
 muovi
 plastik

01 Weiß · white

Incl. 1 x RGBW-LED, 0,1 W

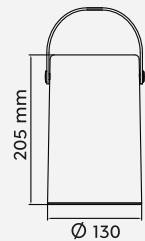

USB-C Anschluss mit Ladefunktion
 Recharging USB-C connection
 Entrée USB-C de rechargement
 Opladende USB-C aansluiting
 Conexión USB-C de recarga
 Connessione USB-C di ricarica
 Conexiune USB-C reîncărcare
 Lataaminen USB-C-liitäntä
 ładowania USB-C połączenie



RGBW Farbwechsler
 RGBW Colorchanging
 Changement de couleur RGBW
 RGBW Kleurverandering
 Cambio de color RGBW
 Cambia colore RGBW
 Schimbator de culoare RGBW
 Värinvaihto RGB
 Zmieniający kolor RGBW



Kunststoff
 plastic
 plastique
 kunststof
 plástico
 plastica
 plastic
 muovi
 plastik

11 Grau · grey

Incl. SMD-LED, 0,02 W

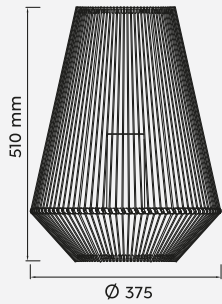
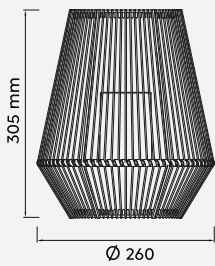

R55256111



R55256911



Flammen-Effekt
 Flame effect
 Effet de flamme
 Vlammeneffect
 Efecto de llamas
 Effetto fiamma
 Efect de flacără
 Liekkitehoste
 Efekt płomienia



Leuchtdauer
 Luminous period
 Durée d'éclairage
 Brandtijd
 Tiempo de iluminación
 Tempo di durata
 Perioada de iluminare
 Valaistusaika
 Czas świecenia



Ladezeit
 Charging time
 Temps de charge
 Oplaadtijd
 Tiempo de carga
 Tempo di carica
 Timp de incarcare
 Latausaika
 Czas ładowania





SANTANA

Aluminium Druckguss, Kunststoff
diecast aluminium, plastic
fonte d'aluminium, plastique
gegoten aluminium, kunststof
aluminio fundido, plástico
pressofusione di alluminio, plastica
fonta aluminiu, plastic
valualumiini, muovi
barwione aluminium, plastik

32 Schwarz matt / Braun ·
black mat / brown

Incl. 1 x SMS-LED, 0,1 W

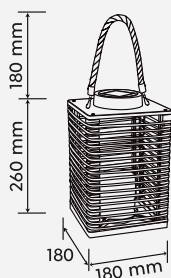

R55346132



Leuchtdauer
Luminous period
Durée d'éclairage
Brandtijd
Tiempo de iluminación
Tempo di durata
Perioada de iluminare
Valaistusaika
Czas świecenia



Ladezeit
Charging time
Temps de charge
Oplaadtijd
Tiempo de carga
Tempo di carica
Timp de încarcare
Latausaika
Czas ładowania



CAMPUS



Metall, Kunststoff
metal, plastic
metale, plastique
metaal, kunststof
metal, plástico
metallo, plastica
metal, plastic
metalli, muovi
metal, plastik

32 Schwarz matt · black mat

Incl. 3 x SMD-LED, 0,1 W

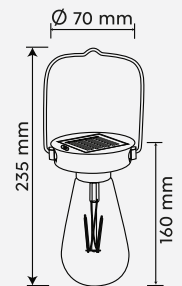

R35146132



Ladezeit
Charging time
Temps de charge
Oplaadtijd
Tiempo de carga
Tempo di carica
Timp de incarcare
Latausaika
Czas ładowania



Leuchtdauer
Luminous period
Durée d'éclairage
Brandtijd
Tiempo de iluminación
Tempo di durata
Perioada de iluminare
Valaistusaika
Czas świecenia



3er Set / Set 3

Kunststoff
 plastic
 plastique
 kunststof
 plástico
 plastica
 plastic
 muovi
 plastik

01 Weiß · white

Incl. 1 x RGBW-LED, 0,5 W

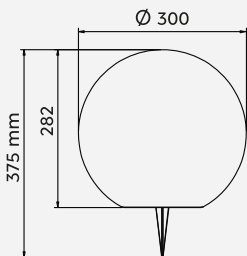
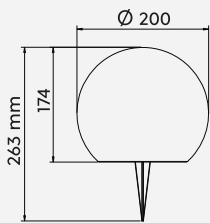

R55326101

R55326901



RGBW Farbwechsler
 RGBW Colorchanging
 Changement de couleur RGBW
 RGBW Kleurverandering
 Cambio de color RGBW
 Cambia colore RGBW
 Schimbator de culoare RGBW
 Värinvaihto RGB
 Zmieniający kolor RGBW



Produkteigenschaften · Features

Caractéristiques · Kenmerken · Acabados ·
Caratteristiche · Caracteristici · Ominaisuudet · Cechy



Schalter · Switch
Interrupteur · Schakelaar · Interruptor ·
Interruttore · Intrerupator · Kytkin ·
Przełącznik



Fernbedienung · Remote control
Commande à distance · Afstandsbediening ·
Mando a distancia · Comando a distanza ·
Telecomanda · Kauko-ohjain · Pilot



Integrierter Dimmer · Integrated dimmer
Variateur intégré · Geïntegreerde dimmer ·
Regulador integrado · Dimmer integrato ·
Variator de lumina integrat · Integroitu himmennin ·
Wbudowany ściemniacz



RGBW Farbwechsler · RGBW Colorchanging
Changement de couleur RGBW ·
RGBW Kleurverandering · Cambio de color RGBW ·
Cambia colore RGBW · Schimbator de culoare
RGBW · Värvivaihto RGB · Zmieniający kolor RGBW



Schwenkbar · Tilttable
Pivotant · Draaibaar · Pivotante ·
Girevole · Pivotant · Suunnattava · Skråtly



Steckdose · Plug
Prise · Stekker · Enchufe · Spina ·
Priza · Katkaisin · Gniazdko



Bewegungssensor · Motion sensor
Détecteur de mouvement · Bewegungssensor ·
Sensor de movimiento · Sensore di movimento ·
Senzor de mişcare · Liiketunnistin · Czujnik ruchu



Dämmerungssensor · Dusk sensor
Décteur de crépuscule · Schemeringsensor ·
Sensor de oscuridad · Sensore crepuscolare ·
Senzor de lumina/amurg · Hämärätunnistin ·
Czujnik zmierzchowy



4 fach TOUCH · 4 level Touch function
Interrupteur tactile 4 niveaux ·
Touch schakelaar 4 niveaus · Función Táctil 4 nivel ·
Interruttore touch 4 livelli · Intrerupator tactil
4 nivele · Kosketuskäyttöinen 4 taso ·
Funkcja dotykowa 4 poziomy



Up and down Beleuchtung ·
Up and Down lighting
Point lumineux en haut et en bas · Lichtpunt boven
en onder · Luz de arriba y abajo · Luce su e giù ·
Sus și în jos lumina · Ylös ja alas valoa ·
W górę iw dół światło



Ohne Leuchtmittel · Lamp(s) excluded
Sans ampoule(s) · Zonder lichtbron(nen) ·
Sin bombilla(s) · Lampadina Esclusa · Fara bec (s) ·
Ilman polttimo (s) · Bez żarówki (s)



USB Anschluss · USB connection
Entrée USB · USB aansluiting · Conexión USB ·
Connessione USB · Conexiune USB ·
USB-liitäntä · Połączenie USB



Lichtfarbe stufenlos einstellbar ·
Light color infinitely variable
Couleur de lumière infiniment variable ·
Lichtkleur traploos instelbaar · Color de luz
infinitamente variable · Colore della luce
infinitamente variabile · Culoare lumină infinit
variabilă · Valon väri portaattomasti ·
Jasny kolor bezstopniowo



Bluetooth Lautsprecher ·
Blouetooth loudspeaker
Haut-parleur bluetooth · Bluetooth luidspreker ·
Altavoz de bluetooth · Altoparlante bluetooth ·
Difuzor Bluetooth · Bluetooth-kaiutin ·
Głośnik Bluetooth



USB Anschluss mit Ladefunktion ·
Recharging USB connection
Entrée USB de rechargement · Opladende USB
aansluiting · Conexión USB de recarga ·
Connessione USB di ricarica · Conexiune USB
reîncărcare · Lataaminen USB-liitäntä ·
Ładowania USB połączenie



Memory Funktion · Memory function
fonction mémoire · Geheugen functie ·
Función de memoria · Funzione memorizzazione ·
functia memorie · Muistitoiminto · Funkcja pamięci



Akkubetrieb · Rechargeable battery operated
Fonctionnement sur batteries rechargeable ·
Oplaadbare accu · Batería recargable ·
Batteria Ricaricabile · Operabil prin baterie
reincarabila · Ladattava akku ·
Akumulator zasilany bateryjnie



Lichtfarbe einstellbar · Adjustable light color
Couleur de lumière réglable · Lichtkleur instelbaar ·
Color de luz regulable · Colore della luce regolabile ·
Lumina colorata reglabila · Värlämpötila säädettä-
vissä · Regulowana barwa światła



DIP SWITCH
Lichtfarben direkt an der Leuchte einstellbar ·
Colours directly adjustable at the lamp
Les couleurs de la lumière peuvent être réglées
directement sur le luminaire · Lichtkleuren direct
instelbaar op de lamp · Tonalidades de luz
ajustables directamente en la lámpara · Colori
della luce regolabili direttamente sulla lampada ·
Colori ale luminii reglabile direct de la bec · Valon
väri asetettävissa suoraan valaisimesta · Barwy
światła można ustawić bezpośrednio na oprawie



Sensordimmer · Sensor dimmer
Variateur tactile · Touchdimmer ·
Regulador con sensor · Touchdimmer ·
Variator cu senzor · Kosketushimmennin ·
Czujnik ściemniania



Kippbar · Tilttable
Inclinable · Kantelbaar · Basculante ·
Inclinabile · Basculant · Kallistettava · Uchylny



Ladezeit · Charging time

Temps de charge · Oplaadtijd · Tiempo de carga · Tempo di carica · Timp de încarcare · Latausaika · Czas ładowania



Leuchtdauer · Luminous period

Durée d'éclairage · Brandtijd · Tiempo de iluminación · Tempo di durata · Perioada de iluminare · Valaistusaika · Czas świecenia



Flammen-Effekt · Flame effect

Effet de flamme · Vlammeneffect · Efecto de llamas · Effetto fiamma · Efect de flacăra · Liekkitehoste · Efekt płomienia



Abstrahlwinkel · Emission angle

Angle de rayonnement · Uitstraalhoek · Ángulo de emisión · Angolo di emissione · Unghiul de emisii · Säteilukulma · Kąt emisji



Belastbarkeit · Resilience

Limite de charge · Belastbaarheid · Resistencia · Resistenza · Reziștența la solicitare · Kuormittavuus · Nośność



Inkl. Verbinder für Reihenschaltung ·

Connector for series connection included

Connecteur pour connexion en série inclus · Connector voor serieaansluiting inbegrepen · Conector para conexión en serie incluido · Connettore per il collegamento in serie incluso · Conector pentru conectarea în serie inclus · Mukana liitin sarjakytkentää varten · W zestawie złącze do połączenia szeregowego



Bewegungssensor und Orientierungslicht.

Die Leuchte verfügt über ein Orientierungslicht, das sich bei Dämmerung oder Dunkelheit automatisch einschaltet. Wird eine Bewegung erfasst, schaltet die Leuchte von Orientierungslicht auf volle Lichtleistung

Motion sensor and orientation light .

The luminaire has an orientation light that switches on automatically at dusk or in the dark.

If movement is detected, the luminaire switches from orientation light to full light output.

Captur de mouvement et lumière d'orientation.

Le luminaire est muni d'une lumière d'orientation qui s'allume automatiquement dès qu'il fait sombre ou dans le noir.

Si un mouvement est détecté, le luminaire passe de la lumière d'orientation à la lumière maximale.

Bewegungssensor en oriëntatielicht.

Het verlichtingstoestel heeft een oriëntatielicht dat automatisch inschakelt bij schemerdonker of in het donker.

Wanneer beweging waargenomen wordt, schakelt het verlichtingstoestel over van oriëntatielicht naar volledig lichtvermogen.

Lámpara con sensor de movimiento y de orientación.

La lámpara dispone de una luz de orientación que se enciende automáticamente al anoecer o en la oscuridad.

Si se detecta movimiento, la lámpara pasa de luz de orientación a plena potencia luminosa.

Sensore di movimento e luce di orientamento.

La lampada è dotata di una luce di orientamento che si accende automaticamente al crepuscolo o al buio.

Se viene rilevato un movimento, la lampada passa dalla luce di orientamento alla piena emissione di luce.

Senzor de mișcare și lumină de orientare.

Corpul de iluminat are o lumină de orientare care se pornește automat în amurg sau în întuneric.

Dacă este detectată mișcare, corpul de iluminat trece de la lumina de orientare la iluminat deplin.

Liiketunnistin ja suuntavalo.

Valaisimessa on suuntavalo, joka syttyy automaattisesti illansarastuksessa tai pimeään laskiessa.

Jos liikettä havaitaan, valaisin siirtyy suuntavalosta täyteen valaistustehoon.

Czujnik ruchu i światło orientacyjne.

Oprawa posiada światło orientacyjne, które włącza się automatycznie o zmierzchu lub w ciemności.

W przypadku wykrycia ruchu oprawa przełącza się ze światła orientacyjnego na pełną moc świetlną.



USB-C Anschluss mit Ladefunktion ·

Recharging USB_c connection

Entrée USB-C de rechargement · Opladende USB-C aansluiting · Conexión USB-C de recarga · Connessione USB-C di ricarica · Conexiune USB-C reîncărcare · Lataaminen USB-C-liitäntä · ładowania USB-C połączenie



Indirekte Beleuchtung · Indirect lighting

Lumière indirecte · Indirecte belichting · Iluminación indirecta · Illuminazione a scomparsa · Iluminat indirect · Epäsuoja valaistus · Oświetlenie pośrednie



USB-C Anschluss · USB-C connection

Entrée USB-C · USB-C-aansluiting · Conexión USB-C · Connessione USB-C · Conexiune USB-C · USB-C-liitäntä · Połączenie USB-C



Inklusive Ladestation ·

Charging station included

Station de recharge incluse · Laadstation inbegrepen · Estación de carga incluida · Stazione di ricarica inclusa · Stație de încărcare inclusă · Latausasema sisältyy · W zestawie stacja ładująca



Solar · Solar

Solaire · Solair · Solar · Solare · Solar · Aurinkokenno · Solar

Farben & Materialien · Colours and materials

Couleurs et matériaux · Kleuren en materialen · Colores y materiales · Colori e materiali ·
Culori si materiale · Värit ja materiaalit · Kolory i materiały

01 Weiß · white

blanc · wit · blanco · bianco · alb · valkoinen · biały

02 Schwarz · black

noir · zwart · negro · nero · negru · musta · czarny

07 Nickel matt · nickel mat

nickel mat · nikkel mat · níquel mate · nichel opaco ·
nichel mat · harjattu teräs · nikiel mat

10 Rot · red

rouge · rood · rojo · rosso · rosu ·
punainen · czerwony

11 Grau · grey

gris · grijs · gris · grigio · gri · harmaa · popielaty

24 rostfarbig · rusty

rouille · roestkleur · óxido · ruggine · ruginiu ·
rustiikki · miedź

28 rostfarbig antik · antique rust

rouille antique · roestkleur antiek · oxido ·
ruggine anticato · ruginiu antic · rustiikki ·
antyczny rdzawy

35 Holznachbildung · wood imitation

imitation bois · houtimitatie · imitación de madera ·
effetto legno · imitație de lemn · puujäljitelmä ·
imitacja drewna

31 Weiß matt · white mat

blanc mat · wit mat · estera blanca · bianco opaco ·
alb mat · valkoinen matto · biały mat

32 Schwarz matt · black mat

noir mat · mat zwart · estera negra · nero opaco ·
negru mat · musta matto · czarny mat

42 Anthrazit · anthracite

antracite · antraciet · antracita · antracite · antracit ·
antrasiitti · antracyt

49 Pistaziengrün · pistachio green

vert pistache · pistachegroen · verde pistacho ·
verde pistacchio · verde fistic · pistaasin vihreä ·
zielony pistacjowy

54 rauchfarbig · smoke

fumé · rookkleur · humo · fume' · fumuriu ·
savu · przydymiony · duman

66 Sand · sable

zand · arena · sabbia · nisip · hiekka · piaskowy ·
kum

77 Ultimate Grau · ultimate grey

gris ultimate · ultiem grijs · gris absoluto ·
grigio assoluto · gri suprem · ultimaattinen harmaa ·
ciemnoszary

83 Illuminate Gelb · illuminate yellow

jaune illuminate · helder geel · amarillo iluminado ·
giallo brillante · galben strălucitor · hehkuvan keltainen ·
swietlisty żółty

Seite Page	Artikel-Nr. Product No.	EAN-Nummer EAN-Number	Seite Page	Artikel-Nr. Product No.	EAN-Nummer EAN-Number
109	201760124	4017807442021	22	220760142	4017807259063
109	201760142	4017807445411	43	220969142	4017807259315
82	201860142	4017807433210	30	221160142	4017807302004
82	201860242	4017807442410	28	221169142	4017807279290
83	201869142	4017807603378	67	221460142	4017807490473
110	201960124	4017807442045	67	221460242	4017807564037
110	201960142	4017807442052	98	221560142	4017807282375
111	202360124	4017807449891	34	221660242	4017807291544
111	202360142	4017807442069	34	221669242	4017807297614
112	202760124	4017807445589	24	221760142	4017807303551
112	202760142	4017807449884	25	221769142	4017807303568
104	204160124	4017807413939	94	222260124	4017807410594
102	204160131	4017807492408	86	222260132	4017807603620
102	204160142	4017807413946	90	222260142	4017807382570
105	204169124	4017807492446	94	222260224	4017807410587
105	204169131	4017807492422	86	222260232	4017807603637
105	204169142	4017807492460	90	222260242	4017807382587
76	204260224	4017807519006	73	222960242	4017807491326
76	204260231	4017807518986	73	222969242	4017807491371
76	204260242	4017807453171	88	224060132	4017807603583
77	204269224	4017807519044	92	224060142	4017807434330
77	204269231	4017807519020	88	224060232	4017807603590
76	204269242	4017807453195	92	224060242	4017807434347
116	205760132	4017807543407	32	225360142	4017807481501
116	205767132	4017807543414	33	225369142	4017807481525
114	205960128	4017807543575	18	226260142	4017807492545
114	205967128	4017807543582	40	226360142	4017807492347
71	206060142	4017807490480	40	226369142	4017807492354
118	206960132	4017807543810	57	226460231	4017807415605
118	206967132	4017807543803	57	226460242	4017807415612
108	207269124	4017807492613	58	226560242	4017807408539
108	207269142	4017807492637	42	226660242	4017807388893
84	207360142	4017807492675	42	226669242	4017807388817
113	210860142	4017807506129	61	226860242	4017807382839
113	210869142	4017807506143	54	226960231	4017807382259
100	211060142	4017807506174	54	226960242	4017807382266
100	211069142	4017807506198	48	227260142	4017807369236
80	211660132	4017807564075	51	227360142	4017807369229
78	211660135	4017807603439	56	227560231	4017807337570
106	212060142	4017807529272	56	227560242	4017807337594
106	212069142	4017807529289	56	227660231	4017807337600
46	212160242	4017807529340	56	227660242	4017807337617
70	212560224	4017807564051	49	227760142	4017807303537
70	212560231	4017807564068	50	228060142	4017807281569
70	212560232	4017807564044	44	228260142	4017807279535
74	214260142	4017807529210	59	228460242	4017807284164
74	214260242	4017807529234	45	228560242	4017807356984
74	214269142	4017807529227	47	228669142	4017807356656
74	214269242	4017807529241	52	228960142	4017807259131
55	218560235	4017807603477	72	229160142	4017807242126
55	218560242	4017807603460	60	229360242	4017807242164
96	220060142	4017807241501	66	240660142	4017807563979
96	220060242	4017807241525	68	240760142	4017807563986

Seite Page	Artikel-Nr. Product No.	EAN-Nummer EAN-Number	Seite Page	Artikel-Nr. Product No.	EAN-Nummer EAN-Number
14	240960142	4017807563993	90	422260142	4017807382600
14	240969142	4017807564006	88	424060132	4017807603613
62	245560131	4017807603415	92	424060142	4017807434361
62	245560142	4017807603392	93	424067142	4017807445404
62	245569131	4017807603422	32	425360142	4017807481563
62	245569142	4017807603408	18	426260142	4017807492576
36	246360142	4017807603484	14	440969142	4017807564020
36	246360242	4017807603491	20	446960135	4017807603736
36	246360342	4017807603507	12	447060142	4017807603750
69	246660342	4017807603514	26	470660142	4017807529197
64	246760231	4017807603521	16	477860142	4017807564112
64	246760232	4017807603538	82	501860142	4017807433234
64	246760431	4017807603545	104	504160124	4017807413977
64	246760432	4017807603552	102	504160142	4017807413991
41	246860142	4017807603569	76	504260142	4017807453218
41	246869142	4017807603576	116	505760132	4017807543421
20	246960135	4017807603705	114	505960128	4017807543599
20	246969135	4017807603712	71	506060142	4017807490497
12	247060142	4017807603767	118	506960132	4017807543827
12	247069142	4017807603774	84	507360142	4017807492705
38	247360142	4017807603781	80	511660132	4017807564082
38	247360242	4017807603798	78	511660135	4017807603446
26	270660142	4017807529111	74	514260142	4017807529258
26	270660242	4017807529159	96	520060142	4017807241563
27	270669142	4017807529135	22	520760142	4017807259100
27	270669242	4017807529166	30	521160142	4017807351590
16	277860142	4017807529333	28	521169142	4017807279313
82	401860142	4017807433258	34	521660242	4017807291568
83	401869142	4017807603385	24	521760142	4017807303575
104	404160124	4017807413953	94	522260124	4017807410563
102	404160142	4017807413960	86	522260132	4017807603644
76	404260142	4017807453232	90	522260142	4017807382594
116	405760132	4017807543445	88	524060132	4017807603606
116	405760332	4017807543452	92	524060142	4017807434354
114	405960128	4017807543605	32	525360142	4017807481549
114	405960328	4017807543612	18	526260142	4017807492569
118	406960132	4017807543834	14	540969142	4017807564013
118	406960332	4017807543841	20	546960135	4017807603729
84	407360142	4017807492729	12	547060142	4017807603743
100	411060142	4017807506211	26	570660142	4017807529173
100	411060342	4017807506228	16	577860142	4017807564105
80	411660132	4017807564099	82	601860242	4017807442397
78	411660135	4017807603453	53	676960131	4017807453393
74	414260142	4017807529265	53	676960142	4017807453416
96	420060142	4017807241792	16	677860142	4017807529326
22	420760142	4017807259087	120	800260142	4017807453133
30	421160142	4017807351583	120	800260342	4017807453157
28	421169142	4017807279306	122	821660107	4017807453287
98	421560242	4017807282405	122	821660207	4017807453348
34	421660242	4017807291551	121	821860142	4017807564143
24	421760142	4017807303582	124	9960-07	4017807259360
94	422260124	4017807410570	123	9962-11	4017807305784
86	422260132	4017807603651	123	9964-42	4017807445299

Seite Page	Artikel-Nr. Product No.	EAN-Nummer EAN-Number	Seite Page	Artikel-Nr. Product No.	EAN-Nummer EAN-Number
125	9965-32	4017807472349	180	R54076101	4017807564273
140	R21186131	4017807564136	158	R54086131	4017807564280
140	R21186132	4017807564129	158	R54086132	4017807564297
132	R21596124	4017807603828	154	R54096131	4017807564327
132	R21596131	4017807603804	154	R54096132	4017807564334
132	R21596132	4017807603811	154	R54096177	4017807564341
132	R21599124	4017807603859	154	R54096631	4017807601671
132	R21599131	4017807603835	154	R54096632	4017807601688
132	R21599132	4017807603842	154	R54096677	4017807601695
130	R21716142	4017807603866	152	R54106110	4017807601817
128	R21719142	4017807603873	152	R54106131	4017807601787
136	R22052142	4017807490428	152	R54106132	4017807601794
136	R22062142	4017807490435	152	R54106149	4017807601800
145	R22151142	4017807453546	152	R54106166	4017807606195
179	R22231107	4017807458220	152	R54106177	4017807601824
179	R22231142	4017807452648	160	R54126131	4017807570571
178	R22241142	4017807452662	160	R54126142	4017807570595
174	R22251142	4017807452686	167	R55086101	4017807444421
176	R22261142	4017807452723	164	R55101101	4017807500271
178	R22281142	4017807452754	182	R55256111	4017807492064
142	R24236142	4017807564150	182	R55256911	4017807492095
143	R24246132	4017807564167	186	R55326101	4017807492101
137	R24256232	4017807564174	186	R55326901	4017807492125
137	R24266232	4017807564181	184	R55346132	4017807529425
138	R27026132	4017807529357	170	R57042001	4017807282801
138	R27036132	4017807529364	168	R57042054	4017807603668
141	R27446132	4017807603699	170	R57043001	4017807282818
134	R28222631	4017807408324	168	R57043054	4017807603675
134	R28222632	4017807411775	170	R57044001	4017807282825
135	R28232631	4017807408317	168	R57044054	4017807603682
135	R28232632	4017807411768	162	R57051101	4017807382518
185	R35146132	4017807529432	163	R57071101	4017807325348
130	R41716142	4017807603903	166	R57080101	4017807407556
128	R41719142	4017807603910	148	R57706110	4017807601732
174	R42251142	4017807452709	148	R57706131	4017807601701
176	R42261142	4017807452730	148	R57706132	4017807601718
164	R45101101	4017807500295	148	R57706149	4017807601725
164	R45101901	4017807500301	150	R57716110	4017807603361
148	R47706110	4017807601770	150	R57716131	4017807603330
148	R47706131	4017807601749	150	R57716142	4017807603347
148	R47706132	4017807601756	150	R57716149	4017807603354
148	R47706149	4017807601763	150	R57716166	4017807606201
130	R51716142	4017807603880	159	R57726131	4017807601831
128	R51719142	4017807603897	159	R57726132	4017807601848
157	R52176101	4017807496314	159	R57726177	4017807603989
157	R52176102	4017807496338	144	R60501031	4017807405873
157	R52176149	4017807541236	144	R60501042	4017807405910
157	R52176177	4017807541274	144	R60502031	4017807405927
157	R52176183	4017807541229	144	R60502042	4017807405934
156	R52306131	4017807540925	145	R62151142	4017807405989
156	R52306132	4017807540901			
156	R52306149	4017807541014			
181	R54066101	4017807564266			



TRIO Leuchten GmbH

Gut Nierhof 17
D-59757 Arnsberg

T +49 (0) 2931 9666-0
F +49 (0) 2931 9666-57

info@trio-leuchten.de
www.trio-leuchten.de

Reality Leuchten GmbH

Gut Nierhof 17
D-59757 Arnsberg

T +49 (0) 2931 9666-99
F +49 (0) 2931 9666-98

info@reality-leuchten.de
www.reality-leuchten.de

BADEN WÜRTTEMBERG, RHEINLAND-PFALZ UND SAARLAND

Antonio De Simone

T +49 (0) 151 5855222
antonio.desimone@trio-leuchten.de

ÖSTERREICH

Wolfgang Melich

T +43 (0) 6605161228
wolfgang.melich@trio-leuchten.de

BAYERN, HESSEN

Martin Kluge

T +49 (0) 171 7300330
martin.kluge@trio-leuchten.de

SCHWEIZ

TRIO Leuchten

T +49 (0) 2931 9666-0
info@trio-leuchten.de

BERLIN, BRANDENBURG, MECKLENBURG-VORPOMMERN, SACHSEN, SACHSEN ANHALT, THÜRINGEN

Jörg Bumke

T +49 (0) 160 7406860
joerg.bumke@trio-leuchten.de

BREMEN, HAMBURG, NIEDERSACHSEN, SCHLESWIG-HOLSTEIN

Jens Gebers

T +49 (0) 170 1615227
jens.gebers@trio-leuchten.de

NORDRHEIN-WESTFALEN

Christian Teller

T +49 (0) 171 4521820
christian.teller@trio-leuchten.de

TRIO International GmbH

Gut Nierhof 17
D-59757 Arnsberg
T +49 (0) 2931 9666-587
F +49 (0) 2931 9666-56
info@trio-lighting.com
www.trio-lighting.com

FRANCE

Stéphane Papierny

Directeur Commercial France
info.france@trio-lighting.com

Julien Lamouret

Product Manager France &
Sales Manager DIY France
info.france@trio-lighting.com

Jean Philippe Bailly

info.france@trio-lighting.com
Agent exclusif pour les départements
60, 75 Nord, 92, 93 et 95

Jean Barel / Bruno Rouquié

info.france@trio-lighting.com
Agent exclusif pour les départements
09, 12, 15, 16, 19, 24, 31, 32, 33, 40, 46,
47, 64, 65, 81, 82 et 87

Jean Marc Beneforti

info.france@trio-lighting.com
Agent exclusif pour les départements
2a et 2b

Christophe Meulien

info.france@trio-lighting.com
Agent exclusif pour les départements
04, 05, 06, 11, 13, 30, 34, 66, 83 et 84

Sullivan Nicolas

info.france@trio-lighting.com
Agent exclusif pour les départements
04, 05, 06, 21, 23, 26, 38, 39, 42, 43, 48,
63, 69, 71, 73 et 74

Stéphane Riebel

info.france@trio-lighting.com
Agent exclusif pour les départements
18, 27, 28, 45, 58, 75 Sud, 76, 77,
78, 89, 91 et 94

Michel Salamand

info.france@trio-lighting.com
Agent exclusif pour les départements
14, 17, 22, 29, 35, 36, 37, 41, 44, 49, 50,
53, 56, 61, 72, 79, 85 et 86

Vincent Zaepffel

info.france@trio-lighting.com
Commercial pour les départements
02, 08, 10, 25, 51, 52, 54, 55, 57, 59, 62,
67, 68, 70, 80, 88 et 90

DANMARK

Jan Rantzau-Bartens

info.denmark@trio-lighting.com

NORDIC & BALTIC

TRIO Lighting Scandinavia Oy

Malmin raitti, rappu 17 B
00700 Helsinki
T +358 (0) 10 23 13 390
tls@trio-lighting.com

*Our Scandinavian organisation represents TRIO
also in Sweden, Norway, Estonia, Latvia, Lithuania
and Iceland*

ITALIA

TRIO Lighting Italia s.r.l

Via Isonzo 81
22066 Mariano Comense (CO)
cormmerciale@trio-lighting.com

ESPAÑA

TRIO Lighting Ibèrica SL

C/ Can Lietget n°9 nave 9
Pol. Ind. Can Roqueta
08206 Sabadell
T +34 (0) 9 35 45 86 30
F +34 (0) 9 33 96 45 48
info.iberica@trio-lighting.com

GREAT BRITAIN

TRIO Lighting UK Ltd.

Unit 5, Hemmells Park Hemmells,
Laindon Essex
SS1s 6GF
T +44 (0) 12 68 88 95 95
F +44 (0) 12 68 88 95 96
sales@trio-lightinguk.com

NEDERLAND

Karl Stok / Bas Martin

info.nederland@trio-lighting.com

BELGIUM

Yves Van den Berghe

info.belgium@trio-lighting.com

ROMANIA

Loredana Barbu

info.romania@trio-lighting.com
loredana.barbu@trio-lighting.com

OUTDOOR

TRIO Leuchten GmbH

Gut Nierhof 17
D-59757 Arnsberg
T +49 2931 9666-0
F +49 2931 9666-28
info@trio-leuchten.de
www.trio-leuchten.de

Reality Leuchten GmbH

Gut Nierhof 17
D-59757 Arnsberg
T +49 2931 9666-99
F +49 2931 9666-98
info@reality-leuchten.de
www.reality-leuchten.de

TRIO International GmbH

Gut Nierhof 17
D-59757 Arnsberg
T +49 2931 9666-587
F +49 2931 9666-56
info@trio-lighting.com
www.trio-lighting.com

 /trioleuchten

 @trio.lighting

 @trioleuchten

 @TRIO Lighting Group

 @triolighting

